

CASSETTE TYPE AIR CONDITIONER OPERATION MANUAL AND INSTALLATION MANUAL



ABH071H1ERG
ABH090H1ERG
ABH105H1ERG



ABH125K1ERG
ABH140K1ERG

Contents

Cautions	3
Parts and Functions	6
Troubleshooting	11
Maintenance	13
Customer Need-to-know	14
Installation Procedure	15
Test Run	23
Move and scrap the air conditioning	23

No. 0150518635 E

- This product must only be installed or serviced by qualified personnel. Please read this manual carefully before installation.

Keep this operation manual for future reference.

Original instructions

Haier

Haier Industrial Park, Qianwangang Road, Eco-Tech Development Zone, Qingdao 266555, Shandong, P.R.C.

EUROPEAN REGULATIONS CONFORMITY FOR THE MODELS

CE

All the products are in conformity with the following European provision:

- Low voltage Directive
- Electromagnetic Compatibility

ROHS

The products are fulfilled with the requirements in the directive 2011/65/EU of the European parliament and of council on the Restriction of the use of Certain Hazardous Substances in Electrical and Electronic Equipment(EU RoHS Directive)

WEEE

In accordance with the directive 2012/19/EU of the European parliament, herewith we inform the consumer about the disposal requirements of the electrical and electronic products.

DISPOSAL REQUIREMENTS:



Your air conditioning product is marked with this symbol. This means that electrical and electronic products shall not be mixed with unsorted household waste. Do not try to dismantle the system yourself: the dismantling of the air

conditioning system, treatment of the refrigerant, of oil and of other part must be done by a qualified installer in accordance with relevant local and national legislation. Air conditioners must be treated at a specialized treatment facility for reuse, recycling and recovery. By ensuring this product is disposed of correctly, you will help to prevent potential negative consequences for the environment and human health. Please contact the installer or local authority for more information. Battery must be removed from the remote controller and disposed of separately in accordance with relevant local and national legislation.

⚠ WARNING

If the supply cord is damaged, it must be replaced by the manufacturer, its service agent or similarly qualified persons in order to avoid a hazard.

This appliance is not intended for use by persons (including children) with reduced physical, sensory or mental capabilities, or lack of experience and knowledge, unless they have been given supervision or instruction concerning use of the appliance by a person responsible for their safety.

Children should be supervised to ensure that they do not play with the appliance.

This appliance can be used by children aged from 8 years and above and persons with reduced physical, sensory or mental capabilities or lack of experience and knowledge if they have been given supervision or instruction concerning use of the appliance in a safe way and understand the hazards involved. Children shall not play with the appliance. Cleaning and user maintenance shall not be made by children without supervision.

The appliances are not intended to be operated by means of an external timer or separate remote-control system.

Keep the appliance and its cord out of reach of children less than 8 years.

The A-weighted sound pressure level is below 70 dB.

This appliance is intended to be used by expert or trained users in shops, in light industry and on farms, or for commercial use by lay persons.

Disconnect the appliance from its power source during maintenance service and when replacing parts.

IMPORTANT INFORMATION REGARDING THE REFRIGERANT USED

Contains fluorinated greenhouse gases covered by the Kyoto Protocol

R410A

1= kg

2= kg

1+2= kg

A

B

C

D

F

E

This product contains fluorinated greenhouse gases covered by the Kyoto Protocol. Do not vent into the atmosphere.

Refrigerant type: R410A

GWP: 2088

GWP = global warming potential

Please fill in with indelible ink,

- 1 the factory refrigerant charge of the product
- 2 the additional refrigerant amount charged in the field and

• 1+2 the total refrigerant charge on the refrigerant charge label supplied with the product. The filled out label must be adhered in the proximity of the product charging port (e.g. onto the inside of the stop valve cover).

A contains fluorinated greenhouse gases covered by the Kyoto Protocol

B factory refrigerant charge of the product: see unit name plate

C additional refrigerant amount charged in the field

D total refrigerant charge

E outdoor unit

F refrigerant cylinder and manifold for charging

Cautions

Disposal of the old air conditioner

Before disposing an old air conditioner that goes out of use, please make sure it's inoperative and safe. Unplug the air conditioner in order to avoid the risk of child entrapment.

It must be noticed that air conditioner system contains refrigerants, which require specialized waste disposal. The valuable materials contained in an air conditioner can be recycled. Contact your local waste disposal center for proper disposal of an old air conditioner and contact your local authority or your dealer if you have any question. Please ensure that the pipework of your air conditioner does not get damaged prior to being picked up by the relevant waste disposal center, and contribute to environmental awareness by insisting on an appropriate, anti-pollution method of disposal.

Disposal of the packaging of your new air conditioner

All the packaging materials employed in the package of your new air conditioner may be disposed without any danger to the environment.

The cardboard box may be broken or cut into smaller pieces and given to a waste paper disposal service. The wrapping bag made of polyethylene and the polyethylene foam pads contain no fluorochloric hydrocarbon.

All these valuable materials may be taken to a waste collecting center and used again after adequate recycling.

Consult your local authorities for the name and address of the waste materials collecting centers and waste paper disposal services nearest to your house.

Safety Instructions and Warnings

Before starting the air conditioner, read the information given in the User's Guide carefully. The User's Guide contains very important observations relating to the assembly, operation and maintenance of the air conditioner.

The manufacturer does not accept responsibility for any damages that may arise due to non-observation of the following instruction.

- Damaged air conditioners are not to be put into operation. In case of doubt, consult your supplier.
- Use of the air conditioner is to be carried out in strict compliance with the relative instructions set forth in the User's Guide.
- Installation shall be done by professional people. Don't install unit by yourself.
- For the purpose of safety, the air conditioner must be properly grounded in accordance with specifications.
- Always remember to unplug the air conditioner before opening inlet grill. Always grip plug firmly and pull straight out from the outlet.
- All electrical repairs must be carried out by qualified electricians. Inadequate repairs may result in a major source of danger for the user of the air conditioner.
- Do not damage any parts of the air conditioner that carry refrigerant by piercing or perforating the air conditioner's

tubes with sharp or pointed items, crushing or twisting any tubes, or scraping the coatings off the surfaces. If the refrigerant spurts out and gets into eyes, it may result in serious eye injuries.

- Do not obstruct or cover the ventilation grille of the air conditioner. Do not put fingers or any other things into the inlet/outlet and swing louver.
- Do not allow children to play with the air conditioner. In no case should children be allowed to sit on the outdoor unit. When the indoor unit is turned on, the PCB will test if swing motor is O.K., and then fan motor will start up. So there is a few seconds to wait.
- In cooling mode, the flaps will swing automatically to a fixed position for anti-condensating.
- This appliance is not intended for use by persons (including children) with reduced physical, sensory or mental capabilities, or lack of experience and knowledge, unless they have been given supervision or instruction concerning use of the appliance by a person responsible for their safety.
- Children should be supervised to ensure that they do not play with the appliance.

Specifications

The refrigerating circuit is leak-proof.

For all the models in this manual, the all-pole disconnection connection method should be applied in the power supply. Such means for disconnection must be incorporated in the fixed wiring.

Cooling	Indoor temperature	max. DB/WB min. DB/WB	32/23°C 18/14°C
	Outdoor temperature	max. DB/WB min. DB/WB	43/26°C 10/6°C
Heating	Indoor temperature	max. DB/WB min. DB/WB	27°C 15°C
	Outdoor temperature	max. DB/WB min. DB/WB	24/18°C -15°C

If the supply cord is damaged, it must be replaced by the manufacturer or its service agent or a similar qualified person. If the fuse on PC board is broken please change it with the type of T 5A /250VAC.

The wiring method should be in line with the local wiring standard.

The waste battery shall be disposed properly.

The indoor unit installation height is at least 2.5m.

The air breaker and the power switch should be installed in a conveniently reachable place for user.

1. Even the machine line cable should be: H05RN-F 4G 2.5mm².

All the cables shall have got the European authentication certificate. During installation, when the connecting cables break off, it must be assured that the grounding wire is the last one to be broken off.

2. Appliances which are intended to be maintained by qualified service personnel and located either in machine rooms and the like or at a level not less than 2,5 m or in secured rooftop areas.

Cautions

Carefully read the following information in order to operate the air conditioner correctly.

Below are listed three kinds of Safety Cautions and Suggestions.

⚠ WARNING: Incorrect operations may result in severe consequences of death or serious injuries.

⚠ CAUTION: Incorrect operations may result in injuries or machine damages; in some cases may cause serious consequences.

⚠ INSTRUCTIONS: These information can ensure the correct operation of the machine.

Symbols used in the illustrations

⊘ :Indicates an action that must be avoided.

⚠ :Indicates that important instructions must be followed.







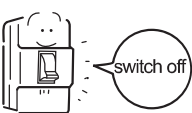

⚡ :Indicates a part which must be grounded.

⚡ :Beware of electric shock (This symbol is displayed on the main unit label.)

After reading this handbook, hand it over to those who will be using the unit.







The user of the unit should keep this manual at hand and make it available to those who will be performing repairs or relocating the unit. Also, make it available to the new user when the user changes hands.





Be sure to conform with the following important Safety Cautions.

⚠ WARNING	
<ul style="list-style-type: none"> • If any abnormal phenomena is found (e. g.smell of firing), please cut off the power supply immediately, and contact the dealer to find out the handling method. In such case, to continue using the conditioner will damage the conditioner, and may cause electrical shock or fire hazard. 	<ul style="list-style-type: none"> • When need maintenance and repairment, call dealer to handle it. Incorrect maintenance and repairment may cause water leak, electrical shock and fire hazard. 
<ul style="list-style-type: none"> • Don't blow the human body with the cooling air too long, and don't let the room temperature decrease too low either. Otherwise the one will feel unpleasant or harm ones' health. 	<ul style="list-style-type: none"> • Don't put fingers or any other things into the inlet/outlet and swing louver while the conditioner is in operation. Because the highspeed fan is very dangerous and may cause injuries. 
<ul style="list-style-type: none"> • Call the dealer to take measures to prevent the refrigerant from leaking. If conditioner is installed in a small room be sure to take every measure in order to prevent suffocation accident even in case of refrigerant leakage. 	<ul style="list-style-type: none"> • Please let the dealer be responsible for installing the conditioner. Incorrect installation may cause water leak, electrical shock and fire hazard. • When conditioner is deinstalled or reinstalled dealer should be responsible for them. Incorrect installation may cause water leaking,electrical shock and fire hazard.
⚠ CAUTION	
<ul style="list-style-type: none"> • Conditioner should not be used for any other purpose other than airconditioning. Don't use air-conditioner for any other special purposes,e.g. the preservation and protectionof food, animals, plants,recision apparatus as well as work of art, otherwise the qualities of these stuffs may be damaged. 	<ul style="list-style-type: none"> • When air-conditioner is co-used with other heat-radiator the frequent replacement of room atmosphere should be required. Inefficient ventilation may cause suffocation. 
<ul style="list-style-type: none"> • Don't dismantle the outlet of the outdoor unit. The exposure of fan is very dangerous which may harm human beings. 	<ul style="list-style-type: none"> • After a long time use of air-conditioner the base should be checked for any damages. If the damaged base is not repaired, the unit may fall down and cause accidents.
<ul style="list-style-type: none"> • Don't dismantle the outlet of the outdoor unit. The exposure of fan is very dangerous which may harm human beings. 	<ul style="list-style-type: none"> • No goods or nobody is permitted to placed onor stand on outdoor unit. The falling of goods and people may cause accidents.

Cautions

⚠ CAUTION

- Don't dismantle the outlet of the outdoor unit.
The exposure of fan is very dangerous which may harm human beings. 
- Pets and plants should not be blown directly in the air flow.
Otherwise will suffer damage. 
- Don't operate the air-conditioner with damp hands.
Otherwise will be shocked. 
- Only use correctly-typed fuse.
May not use wire or any other materials replacing fuse, otherwise may cause faults or fire accidents. 
- Air-conditioner should be cleaned only after power supply is cut off to keep from shock or hurt. 
- Don't clean air-conditioner with water.
Otherwise may cause shock. 

- After a long time use of air-conditioner the base should be checked for any damages.
If the damaged base is not repaired, the unit may fall down and cause accidents. 
- No goods or nobody is permitted to placed on or stand on outdoor unit.
The falling of goods and people may cause accidents. 
- Don't place any burning unit in the air flow of air-conditioner, which may cause incomplete combustion. 
- No inflammable spray fluid should be permitted to be placed or used near to air-conditioner otherwise may cause fire accidents. 
- When use the fumigating insecticide don't open air-conditioner.
Otherwise the poisonous chemicals may settle in air-conditioner which harm the health of chemical-allergic people. 

⚠ INSTRUCTIONS:

Please ask the dealer or specialist to install, never try by the users themselves. After the installation please be sure of the following conditions.

⚠ WARNING:

Please call dealer to install the air-conditioner.

Incorrect installation may cause water leaking, shock and fire hazard.

⚠ CAUTION:

- Air-conditioner can't be installed in the environment with inflammable gases because the inflammable gases near to airconditioner may cause fire hazard.
- Installed electrical-leaking circuit breaker.
It easily cause electrical shock without circuit breaker.
- Connect earthing wire.
Earthing wire should not be connected to the gas pipe, water pipe, lightning rod or phone line, incorrect earthing may cause shock.



Earthing

- Use discharge pipe correctly to ensure efficient discharge.
Incorrect pipe use may cause water leaking.

[Location]

- Air-conditioner should be located in well-vented and easily-accessible place.
- Air-conditioner should not be located in the following places:
 - (a) Places with machine oils or other oil vapours.
 - (b) Seaside with high salt content in the air.
 - (c) Near to hot spring with high content of sulfide gases.
 - (d) Area with frequent fluctuation of voltage e.g. factory, etc.
 - (e) In vehicles or ships.
 - (f) Kitchen with heavy oil vapour or humidity.
 - (g) Near to the machine emitting electric-magnetic waves.
 - (h) Places with acid, alkali vapour, TV, radio, acoustic appliances etc are at least 1 m far away to the indoor unit, outdoor unit, power supply wire, connecting wire, pipes, otherwise images may be disturbed or noises be created.

[Wiring]

Air-conditioner should be equipped with special power supply wire.

[Operating noise]

- Chose the following locations:
 - (a) Capable of supporting air-conditioner weight, don't increase operating noise and vibration.
 - (b) Hot vapour from outdoor unit outlet and operating noise don't disturb neighbour.
No obstacles around the outdoor unit outlet.

Parts and Functions

Component names and applicable models

Indoor unit

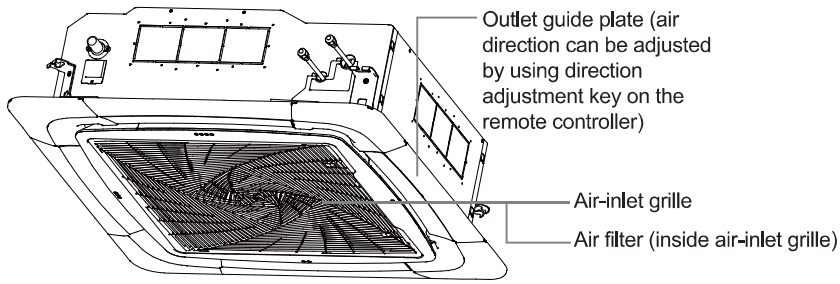

Instructions of HBS-01 Remote Controller:

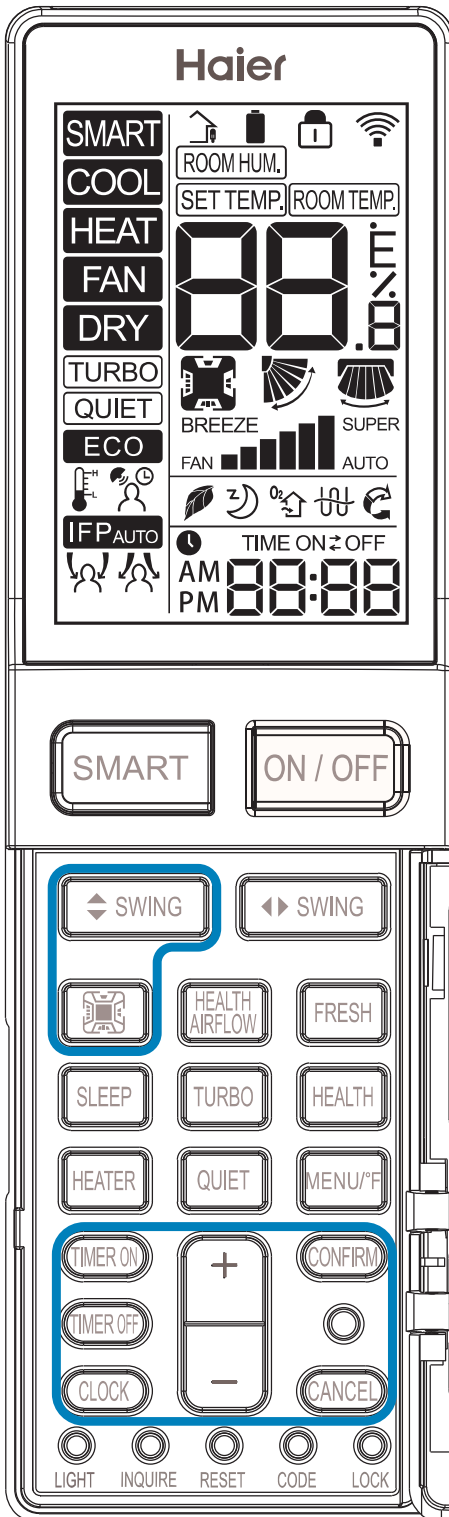

External View of Remote Controller

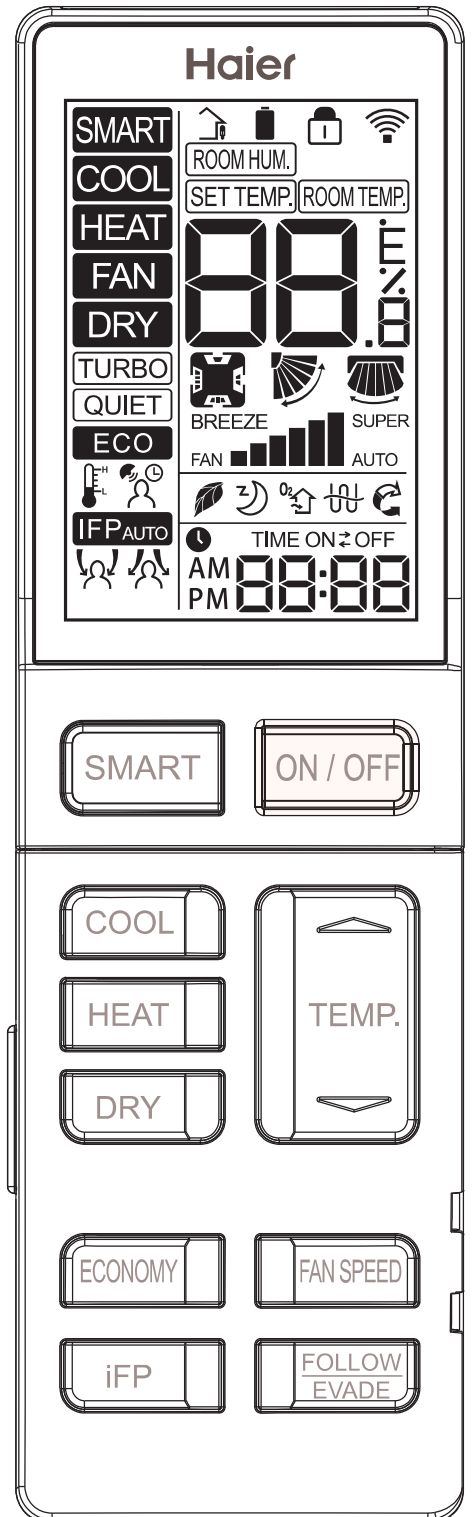

Parts and Functions

Loading of the battery

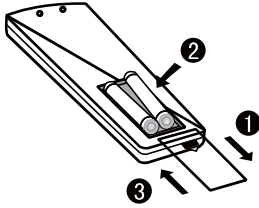

- 1.Remove the battery cover
- 2.Insert 2 AAA batteries as illustrated noting battery polarity
- 3.Reinstall the battery cover

Note:

The distance between the signal transmission head and the receiver hole should be within 7m without any obstacle as well.

When electronic-started type fluorescent lamp or change- over type fluorescent lamp or wireless telephone is installed in the room,the receiver is apt to be disturbed in receiving the signals,so the distance to the indoor unit should be shorter.

Full display or unclear display during operation indicates the batteries have been used up. Please change batteries.

If the remote controller can't run normally during operation, please remove the batteries and reload several minutes later.

Hint:

Remove the batteries in case won't be in use for a long period. If there is any display after taking-out, just press reset key.

Functional description:

1. Power-up and Show All: the LCD display shows all symbols in this function. 3s later, it just shows time and the initial time is AM 12:00. The initial time is adjustable and will be confirmed automatically 10s later.

2. ON/OFF Button: press the button for power on. The initial default mode is SMART, otherwise it will be the mode before power OFF. Press OFF button after power on.

3. SMART Button:

(1) SMART button is always valid during power ON/OFF;

(2) Press SMART button to execute power OFF in SMART mode;

(3) In OFF and other modes, press SMART button to enter initial default setting of SMART mode. LCD setting temperature is not showed;

(4) In SMART mode, press TEMP. +/- button to show the setting temperature.

4. COOL Button, HEAT Button and DRY Button

(1) When the remote controller in ON, press COOL button, HEAT button and DRY button to execute COOL mode, HEAT mode and DRY mode.

(2) For initial power-up, temperature and fan speed will be showed as follows when entering each mode, otherwise parameters set last time will be showed;

Mode	SMART	HEAT	COOL	DRY	FAN
Initial TEMP.	24°C	24°C	24°C	24°C	Setting temperature is not showed.
Mode	SMART	HEAT	COOL	DRY	FAN
Initial Fan Speed	AUTO	LOW	HI	AUTO	LOW

5. FAN Mode

(1) During power OFF, press "HEALTH" button or "FRESH" button to enter FAN mode with low fan speed. Meanwhile, the HEALTH or FRESH icon will be showed on the screen.

(2) Temperature is not showed in FAN mode.







(3) Auto fan speed is not available when switching fan speed in FAN mode.

6. FAN SPEED Button:

(1) In other modes except for Fan mode, LOW, MED, HI and AUTO fan speed is adjustable, switching sequence is as LOW-MED-HI-AUTO-LOW.



Parts and Functions

(2) After TURBO or QUIET is set. Press TURBO button to show  on the screen with fan speed as  , then press "FAN SPEED" button to exit; press QUIET button to show  on the screen with fan speed as  , then press "FAN SPEED" button to exit. To cancel TURBO and QUIET, press TURBO and QUIET buttons respectively,  and  icons will disappear and the fan speed will return to the last one.

(3) This button is invalid during power OFF.

7. TEMP. +/- Button:

(1) This button is invalid in FAN mode;

(2) Temperature adjustment range in SMART, HEAT, COOL and DRY mode: 16 ~30°C.

(3) Press and hold "TEMP. +/- " button, the temperature changes once; long press the button, the temperature changes rapidly.

8. Four-side Embedment (Available for some models):



(1) Initial position of all modes for first power on::

	SMART	HEAT	COOL	DRY	FAN
Four-side Embedment	Show all	Show all	Show all	Show all	Show all
SWING Angle	Position 3	Position 5	Position 3	Position 3	Position 3

(2) After power on, press "Four-side Embedment" button for the first time and the recycle approach is as follows: four-side simultaneous control of Four-side Embedment → Four-side Embedment 1 → Four-side Embedment 2 → Four-side Embedment 3 → Four-side Embedment 4 → Four-side simultaneous control of Four-side Embedment.

(3) When pressing "Four-side Embedment" button to select air deflector, the selected air deflector flashes. Press "Up-and-down Angle" button to adjust angle of air deflector at the moment.

9. Up-and-down SWING Angle:

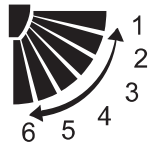

1: Position 1; 2: Position 2; 3: Position 3; 4: Position 4; 5: Position 5; 6: Position 6 (reserved)

Recycle approach: Position 1 → Position 2 → Position 3 → Position 4 → Position 5 → AUTO → Position 1

Free swing: 1 → 2 → 3 → 4 → 5 → 4 → 3 → 2 → 1 is showed circularly.

10. Right-and-left SWING Angle (Available for some models):

Recycle approach: 34 showed (Position 1) → 25 showed (Position 2) → 16 showed (Position 3) → 1 showed (Position 4) → 2 showed (Position 5) → 5 showed (Position 6) → 6 showed (Position 7) → Auto swing

Auto swing approach: 1 → 2 → 3 → 4 → 5 → 6 → 5 → 4 → 3 → 2 → 1 are showed circularly.



11. HEALTH AIRFLOW (Available for some models):

Press "HEALTH AIRFLOW" button to show  icon on LCD display. Each air deflector of swings on four sides alternates circularly to indicate that the swing rotates to exhaust air. Meanwhile, up-and-down SWING angle shows AUTO SWING. Press it again to cancel HEALTH AIRFLOW.

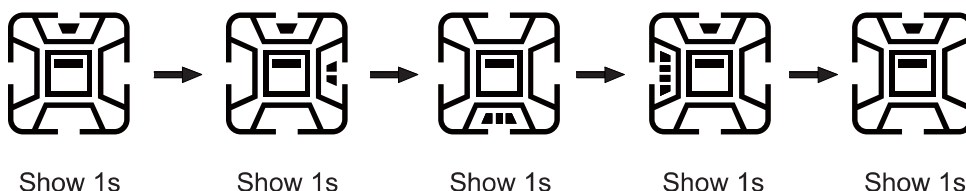



Parts and Functions

12. SLEEP:

- (1) Valid during power on.
- (2) The SLEEP time is fixed to 8 hours and is not adjustable.
- (3) It is invalid in FAN mode. When setting TIMER ON or TIMER ON to TIMER OFF after setting SLEEP function, once the timer setting is successful, the SLEEP function will be cancelled; after setting TIMER ON or TIMER ON to TIMER OFF, the SLEEP function cannot be set. SLEEP function can be set from TIMER OFF to TIMER ON, TIMER OFF and SLEEP function have priority in canceling the opposite side.







13. HEALTH:

- (1) During power-on or power-OFF, press "HEALTH" button to display icon  on LCD display, and press "HEALTH" button again to cancel.
- (2) During power-OFF, press "HEALTH" button to enter blowing-in mode, start low wind and HEALTH mode, display icon .
- (3) Switch among modes, and keep HEALTH function.
- (4) If HEALTH function is set, power OFF and then on to stay in HEALTH mode.



14. ECO:

- (1) Press ECO button and the display will show .
- (2) ECO is valid under all modes, it is memorized among switch of all modes.
- (3) ECO function power-on or power-OFF is memorized.

15. Turbo/Quiet:

- (1) Press button "Turbo", display icon  on remote LCD display, display icon  of fan speed; Press button "Quiet", display icon  on remote LCD display, display icon  of fan speed.
- (2) Turbo and QUIET functions can not exist at the same time, the latter will replace the former.
- (3) If Turbo function is set, press "SLEEP" button to exit turbo, which means that setting SLEEP function while canceling turbo function. At the same time, the icon  disappears and icon  is shown; if QUIET function is set at present, press button "SLEEP" while QUIET function is still kept.
- (4) This function is valid under the mode of COOL or HEAT.
- (5) Turbo/QUIET functions are not memorized among switch of all modes/the state of on or OFF.

16. IFP:

- (1) Press "IFP" button, display , IFP function is set, and press "IFP" button again to cancel.
- (2) Press "Follow/Evade" button, display  that expresses following; press it again, display  that expresses evading. Press it the third time to cancel.
- (3) If follow/evade functions are set, air-out angle will change with position of people, so after setting these functions, Four-side Embedment icons in all sides, up-and-down SWING and left-and-right SWING icons will disappear.
- (4) If air conditioner is in the state of HEALTH airflow, follow/evade functions are set, HEALTH airflow function is cancelled, Four-side Embedment, up-and-down SWING and left-and-right SWING icons will disappear.

17. FRESH (available for some models):

- (1) FRESH function is valid under the state of on or OFF. When air conditioner is OFF, press "FRESH" button, display icon  on LCD display to enter blowing-in mode and low speed. Press "FRESH" button again, this function is cancelled.
- (2) After FRESH function is set, on or OFF functions are kept.
- (3) After FRESH function is set, mode switch function is kept.

18. 10°C Heating Function (available for some models) :

This function is valid only under the mode of HEAT, and it is not memorized under the state of on or OFF.

19. HEAT (available for some models) :

- (1) When HEAT mode is chosen  and is displayed on LCD display, pressing "HEAT" button can cancel and set HEAT function.
- (2) Auto mode will not start HEAT function automatically, but can set or cancel HEAT function.

20. Timer:

(1) TIMER ON

- Press "TIMER ON" button, character "ON" is flashing, press "+/-" button to adjust, then press "OK" button to confirm, if "OK" button is not pressed within 10 s, TIMER ON function is cancelled.
- If time of TIMER ON is the same as that of clock at present, character "ON" is always flashing and can not be verified, it is necessary to readjust time.
- When the time of TIMER ON is end, the setting time and character "on" disappear.

(2) TIMER OFF

- Press "TIMER OFF" button, character "OFF" is flashing, press "+/-" button to adjust, then press "OK" to confirm, if "OK" is not pressed within 10 s, TIMER OFF function is cancelled.

Parts and Functions

- If time of TIMER ON is the same as that of clock at present, character “OFF” is always flashing and can not verified, it is necessary to readjust time.
- When the time of TIMER OFF is end, the setting time and character “OFF” disappear.

(3) TIMER ON/OFF

- After TIMER ON/OFF is set, remote will automatically judge sequential order of ON/OFF, arrow indicates that the one performed first points to the one performed second.
- After the time of clock performed first is end, corresponding characters of timer “ON/OFF” disappear.
- If time of TIMER ON is the same as that of TIMER OFF, and can not be verified, corresponding character of the latter of setting time is always flashing, it is necessary to readjust time and confirm again.
- If time of TIMER ON/OFF is the same as that of clock at present, and can not be verified, it is necessary to readjust time and confirm again.

(4) After setting timer, display the setting of timer first and then display time all the time, when timer is active, character “ON/OFF” is always displayed.

21. Button +/-:

- Press button “+/-”, time will change in terms of 1 min as unit, pressing and holding the button will change quickly.

22. Clock:

- Press “Clock” button, “Morning” or “Afternoon” displayed at present are flashing to enter the state of clock adjustment, adjust clock and then press “OK” to confirm.
- It is valid under the state of ON/OFF.

23. LIGHT:

- No display on remote controller LCD, which is processed by indoor unit.

24. RESET:

- Perform one power on reset operation when RESET button is pressed.

25. LOCK:

- Press button Lock, display Lock symbol on LCD display, buttons on remote controller can not be used, press button Lock again to unlock.

26. CODE:



- Function reserved.

27. INQUIRE



- Processing by Indoor unit

Troubleshooting

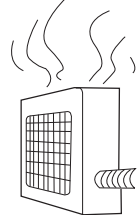
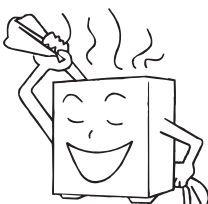
The followings are not malfunction





<p>Water flowing sound is heard</p> 	<p>When the air conditioner is started, when the compressor starts or stops during operation or when the air conditioner is stopped, it sometimes sounds "Bi- Bi-" or "Godo-Godo". It is the flowing sound of the refrigerant, not a malfunction.</p>
<p>Cracking sound is heard</p>	<p>This is caused by heat expansion or contraction of plastics</p>
<p>It smells.</p>	<p>Air blown out from the indoor unit sometimes smells. The smell results from smells of furniture, paint, tobacco absorbed by indoor unit.</p>
<p>During operation, white fog comes out of indoor unit.</p> 	<p>When in COOL or DRY mode, a thin water fog can be seen blown out of unit, this is the condensed fog because the suddenly cooled indoor air is blown out.</p>
<p>Automatically switch into FAN mode during cooling.</p>	<p>To prevent frost from being accumulated on the indoor unit heat exchanger, it sometimes automatically switched into the FAN mode, but it will soon back to the cooling mode.</p>
<p>The air conditioner cannot be restarted soon after it stops. Air conditioner does not start?</p> 	<p>This is because of the self-protection function of the system, therefore, it cannot be restarted for about three minutes after it stops. Please wait for three minutes</p>
<p>Air does not blow or the fan speed cannot be changed during drying.</p>	<p>In DRY mode, when room temperature becomes 2°C higher than temperature setting, unit will run intermittently at LO speed regardless of FAN setting</p>
<p>Water or vapor generated from the outdoor unit during heating.</p> 	<p>This happens when the frost accumulated on the outdoor unit is removed (during defrosting operation).</p> <p style="text-align: right;">Defrosting operation</p> 
<p>During heating, indoor fan is still running even unit is stopped.</p>	<p>To get rid of the excess heat, indoor fan will continue running for a while after unit automatically stops.</p>

Please check the following things about your air conditioner before making a service call.

Unit fails to start.		
<p>Is the power supply switch on ?</p>  <p>Power supply switch is not in ON position.</p>	<p>Is city supply power normal ?</p> 	<p>Is the earth leakage breaker in action ?</p> <p>Be sure to turn off the power supply switch immediately and contact the sales dealer.</p>

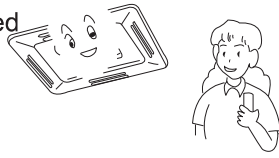
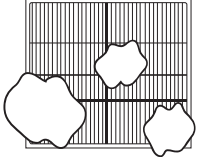
Troubleshooting

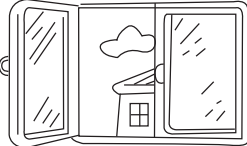
Insufficient cooling or heating

<p>The operation controller adjusted as required</p> 	<p>Air filter too dirty ?</p> 	<p>Horizontal swing louver upward ? (in HEAT mode)</p> 
<p>Any obstacle exists at the air inlet or outlet?</p> 	<p>Door or window left opened ?</p> 	

Insufficient cooling

<p>Any other heat sources in the room?</p> 	<p>Sunlight direct into the room ?</p> 	<p>Too crowded in the room ?</p> 
--	--	--

Cooled air blown out (when heating)

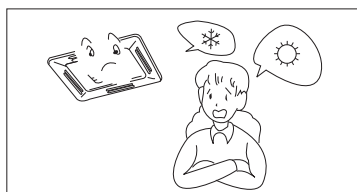

When the air conditioner does not operate properly after you have checked the above-mentioned items or when following phenomenon is observed, stop the operation of the air conditioner and contact your sales dealer.

- 1)The fuse or breaker often shuts down.
- 2)Water drops off during cooling or drying operation.
- 3)There is an irregularity in operation or abnormal sound that is audible.

Trouble shooting



LED flash times of indoor PCB		I.R .RECEIVER DIGITAL DISPLAY	Contents of Malfunction	Possible reasons
LED4	LED1			
0	1	01	Malfunction of indoor unit ambient temperature sensor	Sensor disconnected, or broken, or at wrong position, or short circuit
0	2	02	Malfunction of indoor unit piping temperature sensor	Sensor disconnected, or broken, or at wrong position, or short circuit
0	4	04	EEPROM wrong of indoor PCB	EEPROM chip disconnected or broken or wrong programmed, or PCB broken
0	7	07	Abnormal communication between indoor and outdoor units	Wrong connection, or the wires be disconnected or wrong address setting of indoor unit or faulty power supply or faulty PCB or slave unit malfunction in MAXI system
0	8	08	Abnormal communication between wired controller(or I.R . RECEIVER) and indoor unit	Wrong connection or wired controller broken, or PCB faulty
0	12	0C	Malfunction of drain system	Pump motor disconnected or at wrong position, or the float switch disconnected, or at wrong position, or the short circuit bridge disconnected
0	13	0D	Zero cross signal wrong	Zero cross signal detected wrong
0	14	0E	Indoor unit DC fan motor abnormal	DC Fan motor disconnected or DC Fan broken or circuit broken

Note:

- 1.The outdoor failure can also be indicated by the indoor unit, the checking method as follows:
If the outdoor error code is M(DECIMAL), the indoor unit's I.R. receiver display will show the after converted hexadecimal code of "M+20"(DECIMAL), for example, if the outdoor error code is 2, the indoor unit I.R. receiver display will flash the error code 16 (2→2+20=22→ change decimal 22 to hexadecimal code, get 16)
- 2.LED4 is a red one on the indoor PCB, LED1 is a yellow one.
- 3.To get much more details about the outdoor unit failure, please refer to the outdoor unit trouble shooting list.

Maintenance

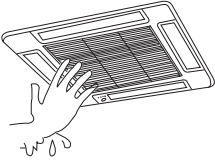
Clean the unit

Turn off the power supply switch	Do not touch with wet hand.	Do not use hot water or volatile liquid
		

NOTE: For detailed information consult dealer.

Air filter washing

- Please don't tear down the air filter, or it may lead to trouble.
- If the environment where the aircon works is full of dust, the air filter should be wash more times than ever (it is usually twice a week).

1. Get the air inlet grille

Look at picture 1, press the two embedding switch vertically to make it close to the side grille, then raise it for about 45° to take the air inlet grille down.

Press the embedding switch according to the direction of the arrowhead.

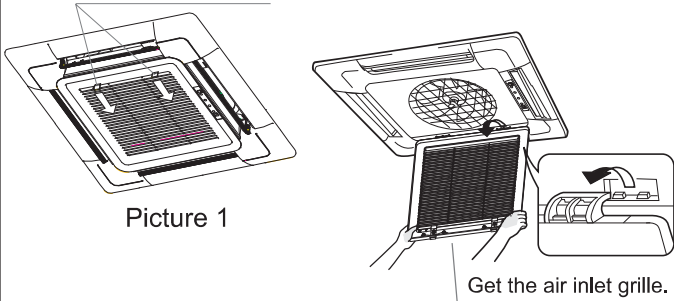

2. Tear down the air filter (Picture 2)

Press the outer brim of the air inlet grille with your thumb, at the same time, pull out the bottom rim of the filter net slightly with your forefinger, so the filter net can part from the embedding switch for us to get it easily.

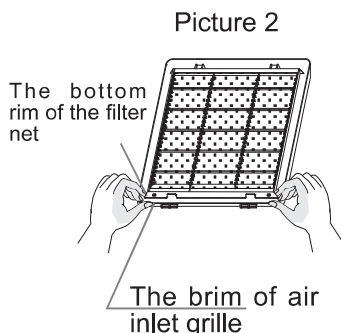

PS: the pictures above are only models, pls obey the real machinery.

Clean the air inlet grille

(1). Open air inlet grille

Pull the two handles at the same time, slowly draw them out. (when closing it, the procedure is reversed.)

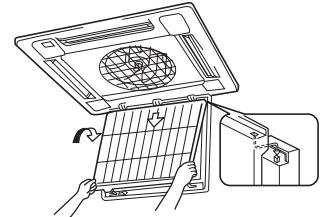

(2). Remove air filter

Referring to "Clean the air filter".

(3). Remove the air inlet grille

Open the air inlet grille for 45°, then lift it up.

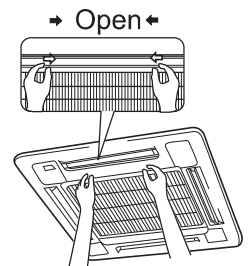

(4). Clean

⚠ Notice

Do not use the hot water over 50°C to clean to avoid discoloration or deformation.

Use soft brush, water and neutral detergent to clean, then throw the water off.

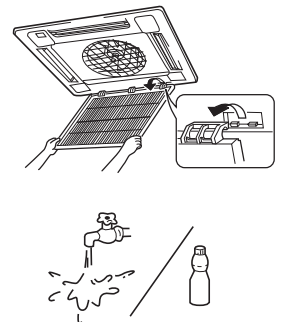

When there is too much dust

Use ventilation fan or directly spray the detergent special for kitchen ware on the air inlet grille, 10 minutes later use water to clean.

(5). Install air inlet grille

Referring to procedure 3.

(6). Install the air filter

Referring to "Clean the air filter"

(7). Close air inlet grille

Referring to procedure 1.

Maintenance

Seasonal Reserve

Post-season Care

Operate the unit with FAN mode on a fair day for about half a day to dry the inside of the unit well.

Stop operation and turn off the power supply switch .Electric power is consumed even the air conditioner is in stop.



Clean the air filter, indoor unit and outdoor unit, and cover the unit with dustcoat.



Pre-season Care

See that there is no obstacles blocking the air inlet and air outlet of both indoor and outdoor unit to avoid reduce the working efficiency.

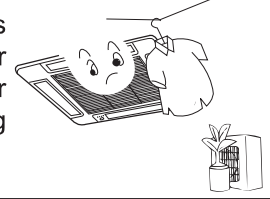

Be sure to install the air filter, ensure that the air filter is not dirty. Otherwise may result in machine damages or cause malfunction due the dust inside the unit

To prevent compressor when start in HEAT mode, please cut in the power supply switch 12 hours before starting run, furthermore, always keep the power supply switch on during the using sensor.

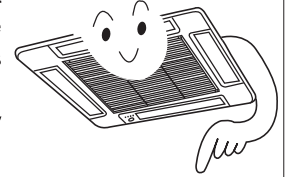

NOTE:

The inner part of indoor unit must be cleaned. Consult dealer, because clean must be done by technician. In cooling operation, discharging system discharge water in room.

Customer Need-to-know

Customer Need-to-know

- Please install the air conditioner according to the requirements specified in this manual to ensure the air conditioner work well.
- Be careful not to scratch the surface of the case during moving the air conditioner.
- Please keep the installation manual for future reference when maintenance and changing installation place.
- After installation ,please use the air conditioner according to the specification in the operation manual.

Using Directions

Adjust suitable airflow direction

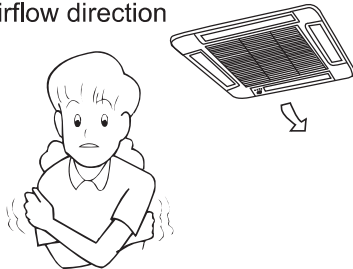

Avoid direct sunlight and airflow



Keep the proper indoor temperature. Too cool or hot is not good for your health. Furthermore, it will result in excessive consumption of electric power.

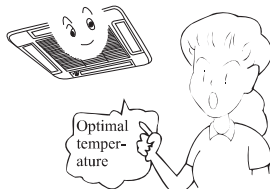

Effectively use timer.

Using TIMER mode, you can make the room temperature reach a suitable temperature when you wake up or back home.

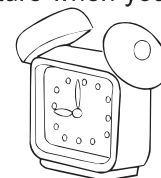

CAUTIONS:

To ensure proper installation, read "Cautions" carefully before working. After installation, start the unit correctly and show customers how to operate and maintain the unit.

Meanings of Warning and Cautions:

⚠ **WARNING:** Serious injury or even death might happen, if it is not observed.

⚠ **CAUTION:** Injury to people or damages to machine might happen, if it is not observed.

⚠ **WARNING:**

- Installation shall be done by professional people, don't install unit by yourself. Incorrect installation will cause water leakage, electric shock or fire.
- Install unit as per the Manual. Incorrect installation will cause water leakage, electric shock or fire accident.
- Be sure to use specified accessories and parts. Otherwise, water leakage, electric shock, fire accident or unit falling down may happen.
- Unit should be placed on a place strong enough to hold the unit. Or, unit will fall down causing injuries.
- When install the unit, take in consideration of storms, typhoon, earthquake. Incorrect installation may cause unit to fall down.
- All electric work shall be done by experienced people as per local code, regulations and this Manual.
- Use exclusive wire for the unit. Incorrect installation or undersized electric wire may cause electric shock or fire accident.
- All the wires and circuit shall be safe. Use exclusive wire firmly fixed. Be sure that external force will not affect terminal block and electric wire. Poor contact and installation may cause fire accident.
- Arrange wire correctly when connecting indoor and outdoor power supply. Fix terminal cover firmly to avoid overheat, electric shock or even fire accident.
- In case refrigerant leakage occurred during unit installation, keep a good ventilation in the room.
- Poisonous gas will occur when meet with fire.
- Check the unit upon installation. Be sure there is no leakage. Refrigerant will induce poisonous gas when meet heat source as heater, oven, etc.
- Cut power supply before touching terminal block.

⚠ **CAUTION:**

- Unit shall be grounded. But grounding shall not be connected to gas pipe water pipe, telephone line. Poor grounding will cause electric shock.
- Be sure to install a leakage breaker to avoid electric shock.
- Arrange water drainage according to this Manual. Cover pipe with insulation materials in case dew may occur. Unproper installation of water drainage will cause water leakage and wet your furniture.
- To maintain good picture or reduce noise, keep at least 1 m from T.V. radio, when install indoor and outdoor unit, connecting wire and power line. (If the radio wave is relatively strong, 1 m is not enough to reduce noise).
- Don't install unit in following places:
 - (a) Oil mist or oil gas exists, such as kitchen, or, plastic parts may get aged, or water leakage.
 - (b) Where there is corrosive gas. Copper tube and welded part may be damaged due to corrosion, causing leakage.
 - (c) Where there is strong radiation. This will affect unit's control system, causing malfunction of the unit
 - (d) Where flammable gas, dirt, and volatile matter (thinner, gasoline) exist, These matter might cause fire accident.
- Refer to paper pattern when installing unit.



Cautions for the installation personnel

Don't fail to show customers how to operate unit.

1 BEFORE INSTALLATION <Don't discard any accessories until comp>

- Determine the way to carry unit to installation place.
- Don't remove packing until unit reaches installation place.
- If unpacking is unavoidable, protect unit properly.

2 SELECTION OF INSTALLATION PLACE

(1) Installation place shall meet the following and agreed by customers:

- Place where proper air flow can be ensured.
- No block to air flow.
- Water drainage is smooth.
- Place strong enough to support unit weight.
- Place where inclination is not evident on ceiling.
- Enough space for maintenance.
- Indoor and outdoor unit piping length is within limit. (Refer to Installation Manual for outdoor unit.)
- Indoor and outdoor unit, power cable, inter unit cable are at least 1 m away from T.V. radop. This is helpful to avoid picture disturbance and noise. (Even if 1 m is kept, noise can still appear if radio wave is strong)

(2) Ceiling height

Indoor unit can be installed on ceiling of 2.5-3m in height. (Refer to Field setting and Installation Manual of ornament panel.)

(3) Install suspending bolt.

Check if the installation place is strong enough to hold weight. Take necessary measures in case it is not safe. (Distance between holes are marked on paper pattern. Refer to paper pattern for place need be reinforced)

(4) Selection of installation location of outdoor

With consent from the user, installation location shall:

- Be sufficient to bear weight of the units, with air circulation.
- Avoid direct radiation from heat sources or other heat sources.
- Facilitate the drainage of condensate. Holes in wall shall also facilitate drainage.
- Be such that noise and heat air will not disturb neighbors.
- Be free of heavy snow in winter.
- Allow air inlets and outlets to be free of barriers.
- Not allow air outlet to directly face strong airflow.
- Facilitate installation at four corners, with 1m space above the unit.
- Be convenient for maintenance and repair.
- For installation of multiple units, sufficient space shall be ensured to avoid short circuit.
- The air conditioner shall not be mounted on a non-dedicated metal frame (e.g. burglar mesh).
- When the outdoor unit is installed on a street side, its height shall not be less than 2.5m.

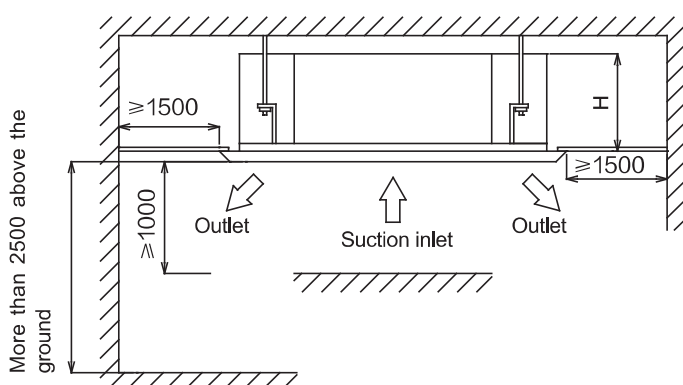

Space required for installation (unit: mm)

Model	H
ABH071H1ERG ABH090H1ERG ABH105H1ERG	246
ABH125K1ERG ABH140K1ERG	288

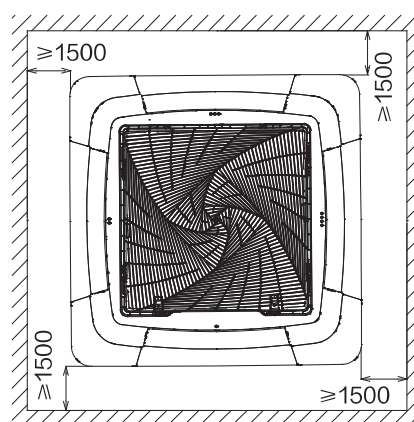

3 Preparation before installation

(1) Location relationships between ceiling opening and hanging screw

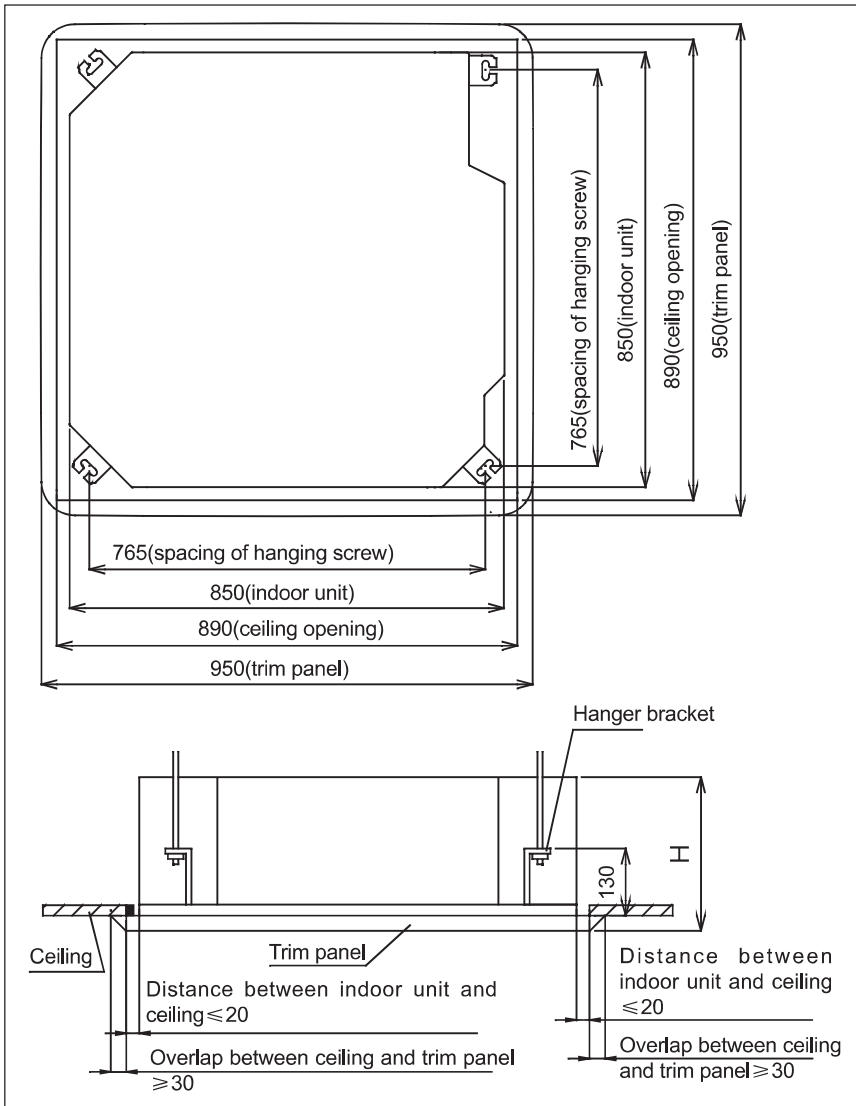

Model	H
ABH071H1ERG ABH090H1ERG ABH105H1ERG	299
ABH125K1ERG ABH140K1ERG	341

Note:

Overlap between the ceiling and decorative panel shall be 30mm or more. The distance between indoor unit and ceiling shall be 20mm or less. If it's more than 20mm, add ceiling materials at ■ or repair the ceiling.

(2) Complete all pipes (for refrigerants and drainage) and wires (for connection of indoor and outdoor units) to be connected to indoor unit before installation so that they can be connected to indoor unit immediately after installation.

(3) Install hanging screws

- To bearing the unit weight, use foundation bolts on existing ceilings, or embedded bolts, buried bolts or other parts that is provided on site on new ceilings. Before installation is continued, adjust the distance from ceiling.

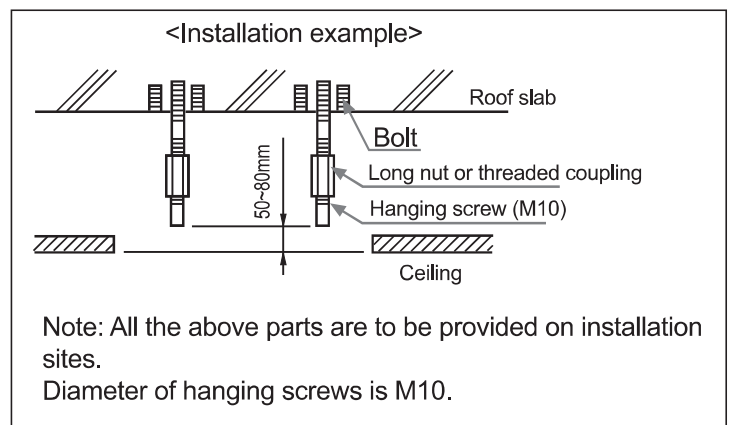

4 Installation of indoor unit

Installation sequence on new ceiling: (1)→(2)→(3)→(4)→(5)→(6)

Installation sequence on new ceiling: (1)→(3)→(4)→(5)

(1) Temporary installation of indoor unit

- Attach hangers to hanging screws, and make sure to use nuts and washers on both upper and lower ends of hangers so as to fix them firmly. A washer fixing plate (to be provided on site) can prevent the washer from dropping off.

<Work at ceilings>

(2) Adjust units to appropriate installation locations.
Refer to "(3)Preparation before installation."

(3) Correct levelness of air conditioner units.

- The indoor unit is equipped with a built-in drainage pump and a float switch. Correct levelness with a level or water-filled polyethylene pipe.

Note: if the unit inclines towards reverse direction of condensate flow, the float switch can not work normally and water leakage will be resulted.

(4) Pull out the original fixing plate that prevents the washer from dropping off, and tighten nuts.

(5) Remove the installation cardboard.

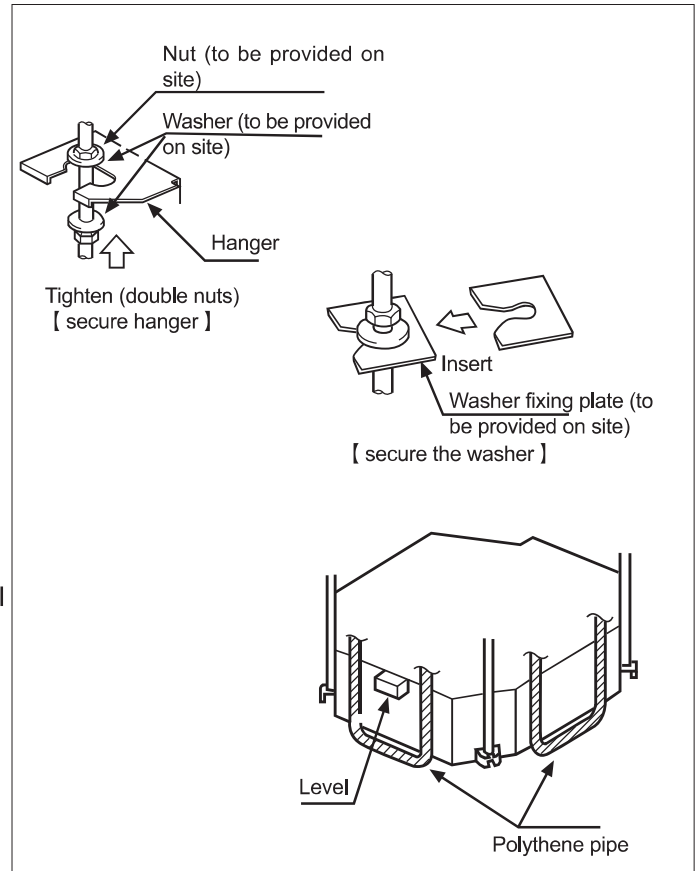

5 Installation of drain pipe

(1) Install drain pipe

- Diameter of the drain pipe shall be greater than or equal to that of the connecting pipe.
(PE pipe: size: 25mm; O.D.: 32mm)
- The drain pipe shall be short and have a downward slope of at least 1/100 to prevent pockets.
- If it is impossible to provide sufficient slope to the drain pipe, a drain lift pipe shall be installed.
- To avoid bending of the drain pipe, hangers shall be kept 1-1.5m away from each other.



Use a drain hose and clamp.

Insert the drain hose into the drainage outlet until it reaches the white tape. Then tighten the clamp.

For heat insulation, wind the drain hose with sealing gaskets. Provide heat insulation to indoor drain hose.

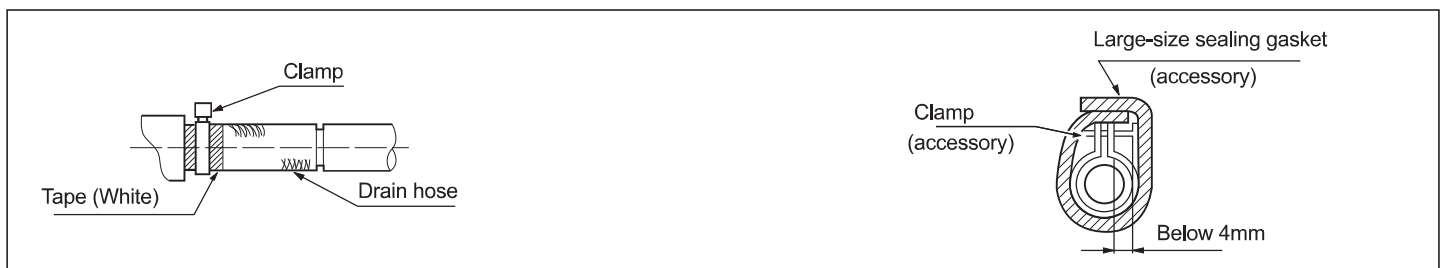

<Precautions for drain lift pipe>

The drain lift pipe shall be installed as low as possible.

The drain lift pipe shall be perpendicular to the unit and not more than 300mm away from the unit

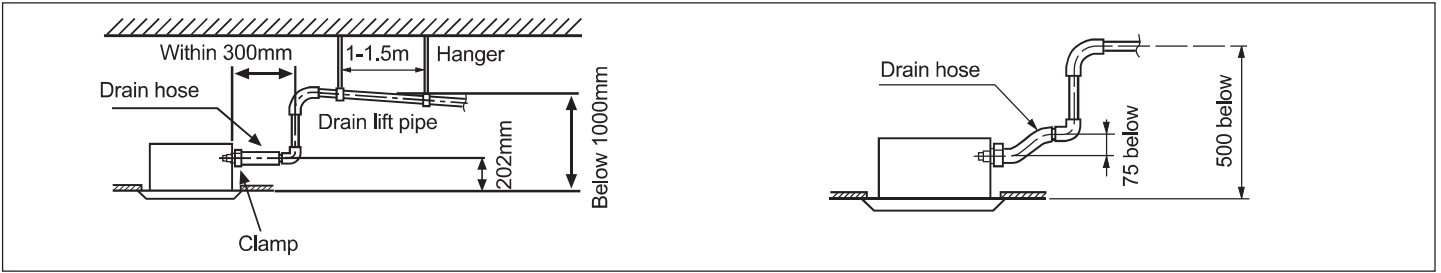

Note:

- The slope of accessory drain pipe shall be within 75mm so that the drainage outlet does not necessarily bear excessive external force.
- If multiple drain pipes join together, install them as follows.

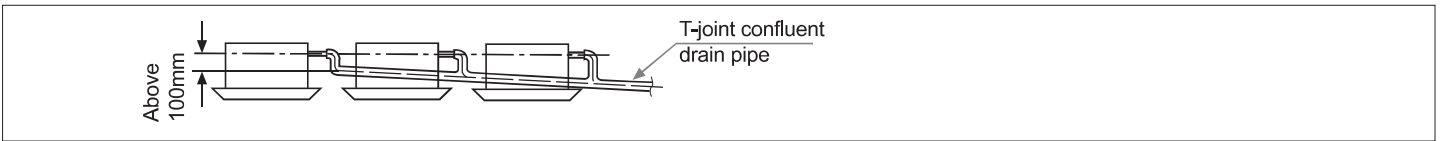

The size of confluent drain pipe selected shall be suitable for operating capacity of the units.

(2) Check drainage is smooth after installation.

- Check drainage by filling in 1200cc water slowly from air outlet or inspection hole.

6 Installation Instruction for Embedded Air-Conditioning Panel

1. Before installation

Warning

The trim panel shall be put on buffer materials when unpacked to prevent being scratched by hard objects.

Please confirm the following accessories delivered with the product:

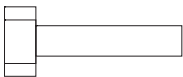

Bolt (M5*25) Qty: 4



Gasket Qty: 4

Connect and fix the power supply cable, indoor-outdoor connection cable as following:

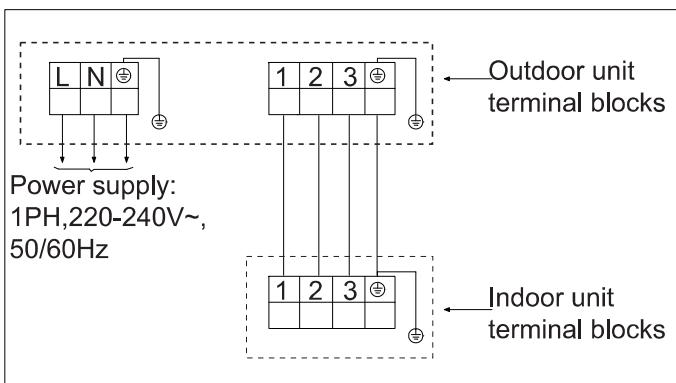

For single phase power supply models:
1UH071N1ERG, 1UH090N1ERG, 1UH105N1ERG,
1UH125P1ERG, 1UH140P1ERG
Power supply cable: H05RN-F 3G 4.0mm²
Indoor and outdoor connection cable: H05RN-F 4G 2.5mm²

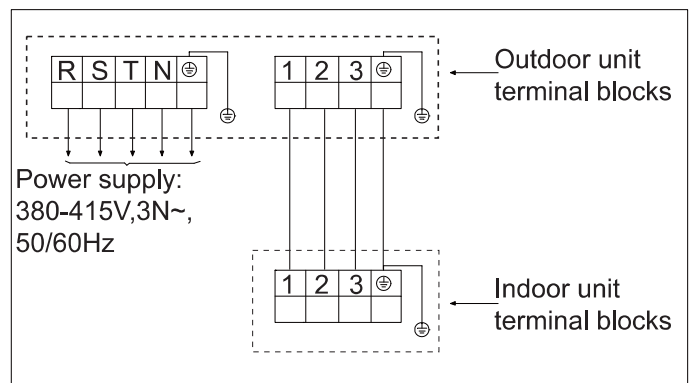

For three phase power supply models:
1UH125P1ERK, 1UH140P1ERK
Power supply cable: H05RN-F 5G 2.5mm²
Indoor and outdoor connection cable:
H05RN-F 4G 2.5mm²

Wired controller wiring instruction

Alert! Ensure do any of the operating during power off.

A. One Wired controller controls one indoor unit

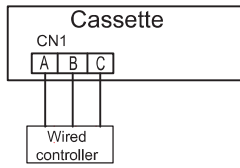

B: Double wired controllers control one indoor unit

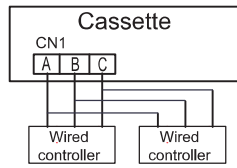

C. Connection method for ONE wired controller with MULTIPLE indoor units

For wired controller connect with cassette (AB**SC2VHA)

Step1:The wiring connection between 1.wired controller-the master unit(directly connected to the wired controller), 2.master unit-slave unit, 3.slave unit-slave unit should be one to one match of all three lines. The connection wiring is as following, and max. Quantity of the connected indoor units is16.

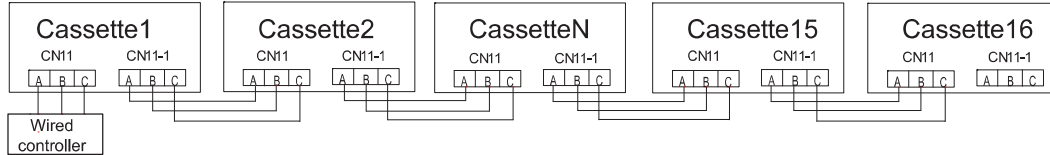

- Note:**
- 1) Shielded lays of the communication line should be connected as a daisy chain from the first master unit to the last slave unit.
 - 2)The shielding lay of the communication line must be grounded at the end of the last slave unit.

Step2

Setting the dip switch BM3, and the indoorunit should be set according to the following table:

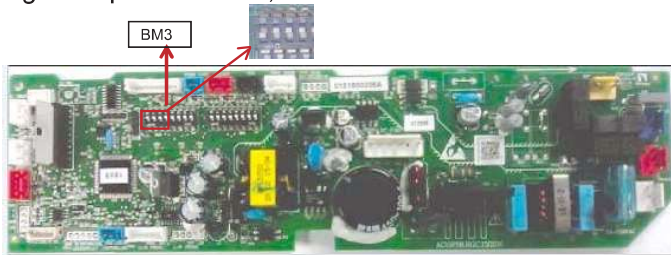

Wired controller address	BM3-8	BM3-7	BM3-6	BM3-5
Master indoor unit	0	0	0	0
Slave unit1	0	0	0	1
Slave unit2	0	0	1	0
Slave unit3	0	0	1	1
Slave unit4	0	1	0	0
Slave unit5	0	1	0	1
Slave unit6	0	1	1	0
Slave unit7	0	1	1	1
Slave unit8	1	0	0	0
Slave unit9	1	0	0	1
Slave unit10	1	0	1	0
Slave unit11	1	0	1	1
Slave unit12	1	1	0	0
Slave unit13	1	1	0	1
Slave unit14	1	1	1	0
Slave unit15	1	1	1	1

"1" stands for ON," 0" stands for OFF.

Note:

The above step 1, step 2, and step 3 must be operated in power off status.

The power supply terminals L1 L2 of all the outdoor units must be in the same phase sequence.

Installation Procedure

Indoor unit

1. Installation

(1) Confirming the position of unit hanger

Please confirm the installation position of the hanger for indoor unit is about 130mm above the ceiling. For details, please refer to the Instructions for Installation and Maintenance of indoor unit.

(2) Removing the air-inlet grille

Open the air-inlet grille to make it at an angle of 45° to the trim panel. As shown in the following figure, please remove the air-inlet grille as per the operation requirements.

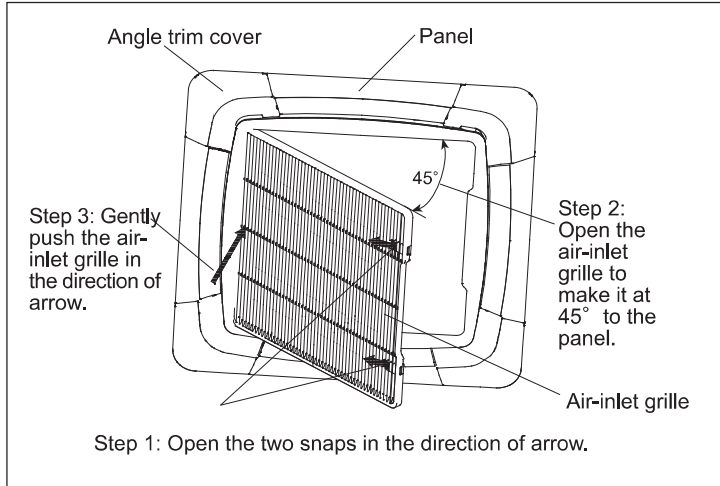

(3) Installing the panel

1) Please remove the four (4) angle trim panels. Removal method: Flip the jack catches of the angle trim panel in the order of ①②③④, as shown in the following figure. The flipping direction is indicated by the arrows. Then the angle trim panel can be removed.

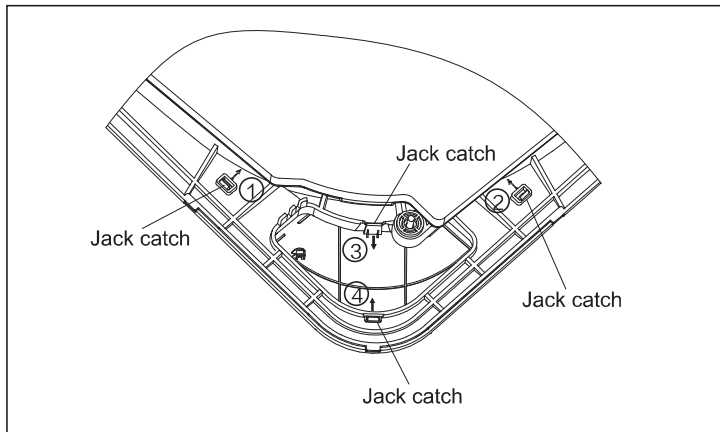

2) Pull out the two (2) U-shaped hooks on the indoor unit from below.

3) Adjust the panel direction to make the angle side engraved with "Pipe side" consistent with the refrigerant pipe of the indoor unit, and make the angle side engraved with "Drain side" consistent with the drain side of the indoor unit. Then hang the 2 hooks in the inner side of the panel on the 2 U-shaped hooks of the indoor unit.

4) Finally fix the panel on the indoor unit with the bolts (M5*25) and gaskets delivered with the unit.

Caution: Gaskets must be used for fixing, or else the panel would be easy to fall off.

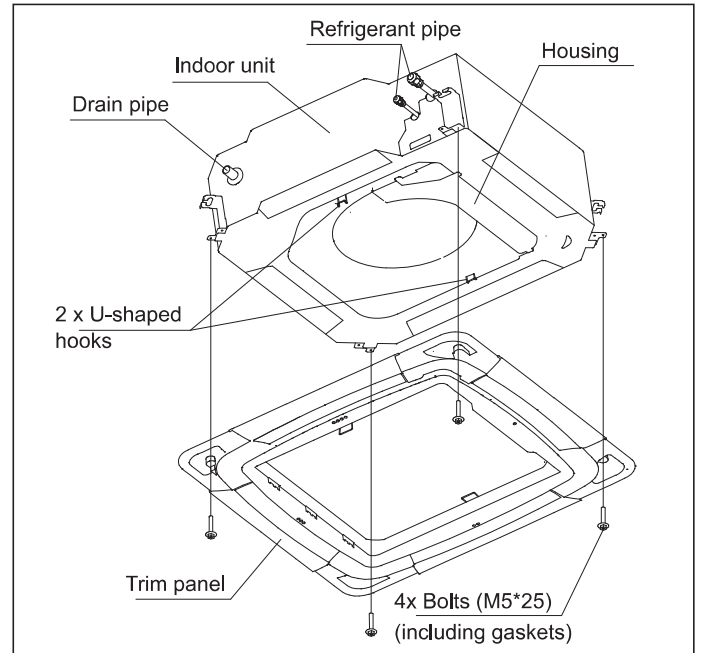

5) When tightening the four (4) bolts, please make sure there is no clearance between the panel fixing seat on the side of the indoor unit and the panel fixing seat on the side of the panel. That is to say: the bolts shall be fully tightened (see * in the figure). If there is a clearance, air leakage or water leakage is likely to occur.

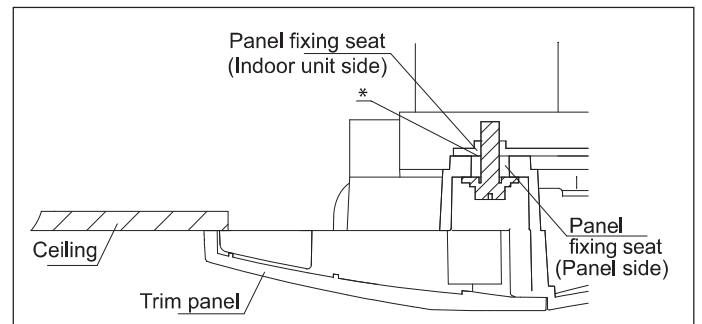

Caution:

• Improper tightening of bolts would lead to the faults shown in the following figure.

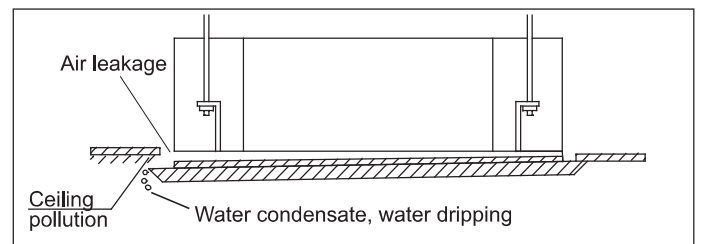

• After tightening the bolts, if there is a clearance between the ceiling and the trim panel, please readjust the height of the indoor unit.

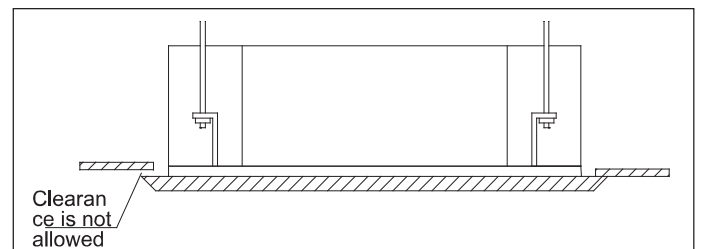

If the elevation level of the indoor unit and drain pipe are not affected, you can adjust the height of the indoor unit through the corner pore on the trim panel. Please keep the unit horizontal in the process of adjustment, or else water leakage is easy to occur.

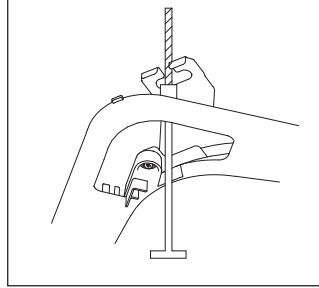

- Please do not swing the louver blade by hand, or else the blade mechanism would be damaged.

6) Connection of trim panel. Connect the black lead-out terminal of the panel to the black lead-out terminal of the indoor unit housing.

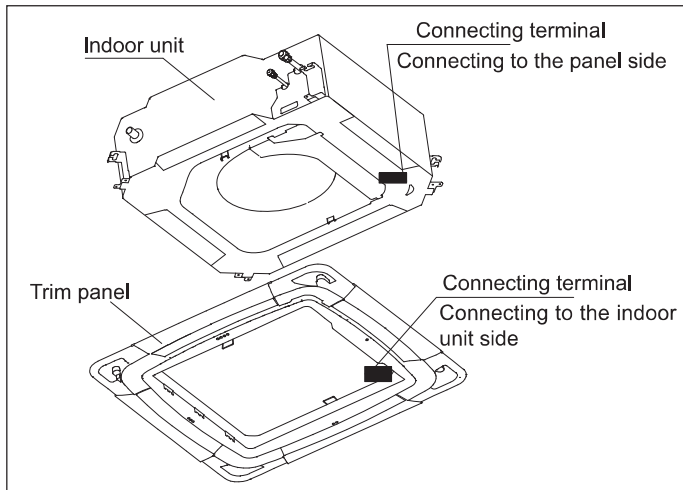

8) Installing the air-inlet grille.

Install the air-inlet grille with the steps opposite to that for removing.

For reference

The method for removing angle trim panels when the installation of trim panel is complete:

- 1) Insert a straight screwdriver in the notch ①. Gently turn the screwdriver downward, and slowly insert it in, and then move it up and down to make the angle fall off.
- 2) Make the angle ② and ③ fall off in the same way.
- 3) Take off the angle trim panel by hand.

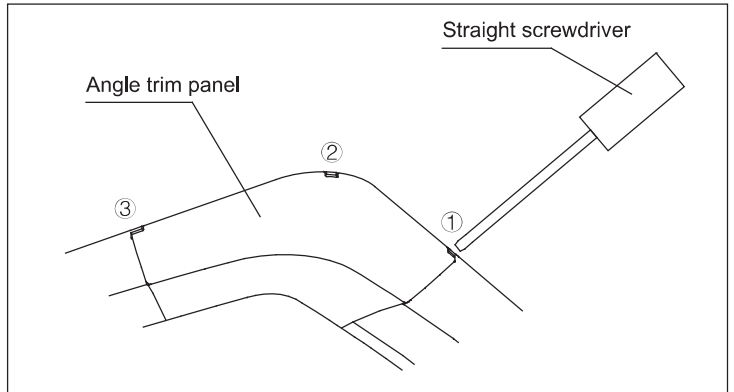

7) When the installation of panel is complete, please fix the four (4) angle trim panels.

- Hang and tighten the strap of the angle trim panel on the shackle of the trim panel, as shown in the figure.
- Fix the angle trim panel on the trim panel.

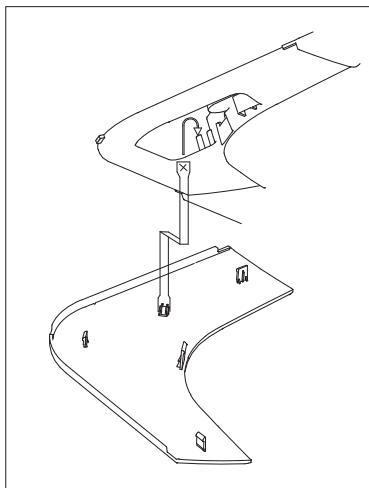

Test Run

Check items

1. Indoor unit

- Is operation of each button on the remote control unit normal?
- Does each lamp light normally?
- Do not air flow direction louvers operate normally?
- Is the drain normal?

2. Outdoor unit

- Is there any abnormal noise and vibration during operation?
- Will noise, wind, or drain water from the unit disturb the neighbors?
- Is there any gas leakage?

Customer guidance

Explain the following to the customer in accordance with the operation manual:

- (1) Starting and stopping method, operation switching, temperature adjustment, timer, air flow switching, and other remote control unit operations.
- (2) Air filter removal and cleaning, and how to use air louvers.
- (3) Give the operation and installation manuals to the customer.

Test run

CAUTION

THIS UNIT WILL BE STARTED INSTANTLY WITHOUT "ON" OPERATION WHEN ELECTRIC POWER IS SUPPLIED. BE SURE TO EXECUTE "OFF" OPERATION BEFORE ELECTRIC POWER IS DISCONNECTED FOR SERVICING.

- This unit has a function of automatic restart system after recovering power stoppage.

1. Before starting test run (for Heat pump models)

Confirm whether the power source breaker (main switch) of the unit has been turned on for over 12 hrs to energize the crankcase heater in advance of operation.

2. Test run

Run the unit continuously for about 30 minutes, and check the following.

- Suction pressure at check joint of service valve for gas pipe.
- Discharge pressure at check joint on the compressor discharge pipe.
- Temperature difference between return air and supply air for indoor unit.

Move and scrap the air conditioning

- When moving, to disassemble and re-install the air conditioning, please contact your dealer for technical support.
- In the composition material of air conditioning, the content of lead, mercury, hexavalent chromium, polybrominated biphenyls and polybrominated diphenyl ethers are not more than 0.1% (mass fraction) and cadmium is not more than 0.01% (mass fraction).
- Please recycle the refrigerant before scrapping, moving, setting and repairing the air conditioning; for the air conditioning scrapping, should be dealt with by the qualified enterprises.



Haier

Address: Haier Industrial Park, Qianwangang Road, Eco-Tech Development Zone, Qingdao 266555, Shandong, P.R.C.

Contacts: TEL +86-532-88936943; FAX +86-532-8893-6999

Website: www.haier.com