

PACKAGED TYPE ROOM AIR CONDITIONER OPERATION MANUAL AND INSTALLATION MANUAL



English

AP71DFCHRA/1U71RECFRA
AP24DFCHRA/1U24RECFRA

- Please read this manual before using the air conditioner.
Keep this manual for future reference.
This appliance is filled with R32.

0011509384



Contents

PARTS AND FUNCTIONS.....	11
OPERATION.....	12
CAUTIONS.....	19
TROUBLE SHOOTING.....	20
INDOOR AND OUTDOOR UNIT INSTALLATION.....	21
MAINTENANCE AND WIFI FUNCTION.....	25



Read the precautions in this manual carefully before operating the unit.



This appliance is filled with R32.

Keep this manual where the user can easily find it.

English

WARNING:

- Do not use means to accelerate the defrosting process or to clean, other than those recommended by the manufacturer.
- The appliance must be stored in a room without continuously operating ignition sources (for example: open flames, an operating gas appliance or an operating electric heater).
- Do not pierce or burn.
- Be aware that refrigerants may not contain an odour.
- The appliance must be installed, operated and stored in a room with a floor area larger than 3m².
- If the supply cord is damaged, it must be replaced by the manufacturer, its service agent or similarly qualified persons in order to avoid a hazard.
- This appliance can be used by children aged 8 years and above and persons with reduced physical, sensory or mental capabilities or lack of experience and knowledge if they have been given supervision or instruction concerning use of the appliance in a safe way and understand the hazards involved. Children shall not play with the appliance.
- The appliance shall be installed in accordance with national wiring regulations
- All the cables shall have got the European authentication certificate. During installation, when the connecting cables break off, it must be assured that the grounding wire is the last one to be broken off. The explosion-proof breaker of the air conditioner should be all-pole switch. Distance between its two contacts should be not less than 3mm. Such means for disconnection must be incorporated in the wiring.
- Make sure installation is done according to local wiring regulation by professional persons.
- Make sure ground connection is correct and reliable.
- A leakage explosion-proof breaker must be installed.
- Do not use a refrigerant other than the one indicated on the outdoor unit (R32) when installing, moving or repairing. Using other refrigerants may cause trouble or damage to the unit, and personal injury.

Loading and Unloading/Transporting Management/Storage Requirements

• Loading and Unloading Requirements

- 1) The products shall be carefully handled during loading and unloading.
- 2) Rude and barbarous handling such as kicking, throwing, dropping, bumping, pulling and rolling is not allowed.
- 3) The workers engaged in loading and unloading must be subject to necessary trainings on the potential hazards caused by barbarous handling.
- 4) Dry powder extinguishers or other suitable fire extinguishing apparatus within the period of validity shall be equipped at the loading and unloading site.
- 5) The untrained personnel cannot be engaged in loading and unloading of flammable refrigerants air conditioner.
- 6) Before loading and unloading, anti-static measures shall be taken, and phones cannot be answered during loading and unloading.
- 7) Smoking and open fire are not allowed around the air conditioner.

• Transporting Management Requirements

- 1) The maximum transporting volume of finished products shall be determined as per local regulations.
- 2) The vehicles used for transporting shall be operated as per local laws and regulations.
- 3) Dedicated after-sales vehicles shall be used for maintenance, and exposed transporting of refrigerant cylinders and the products to be maintained is not allowed.
- 4) The rain cover or similar shielding material of transporting vehicles shall be provided with certain flame retardancy.
- 5) Leakage warning device of flammable refrigerant shall be installed inside the closed-type compartment.
- 6) Anti-static device shall be equipped inside the compartment of transporting vehicles.
- 7) Dry powder extinguishers or other suitable fire extinguishing apparatus within the period of validity shall be equipped inside the driver's cab.
- 8) Orange-white or red-white reflective stripes shall be pasted on the sides and tail of the transporting vehicles, to remind the vehicles behind of keeping distance.
- 9) The transporting vehicles shall run at a constant speed, and heavy acceleration/deceleration shall be avoided.
- 10) Combustibles or the static articles cannot be transported simultaneously.
- 11) High-temperature area shall be avoided during transporting, and necessary radiating measures shall be taken in case the temperature inside the compartment is too high.

• Storage Requirements

- 1) The storage package of equipment used shall be such that no leakage of refrigerant will be caused due to mechanical damage of the equipment inside.
- 2) The maximum quantity of the equipment allowed to be stored together shall be determined as per local regulations.

Installation Instructions

• Installation Precautions

WARNING!

- ★ The area of the room in which R32 refrigerant air conditioner is installed cannot be less than the minimum area specified in the table below, to avoid potential safety problems due to out-of-limit of refrigerant concentration inside the room caused by leakage of refrigerant from refrigeration system of the indoor unit.
- ★ Once the horn mouth of connecting lines is fastened, it may not be used again (the air tightness may be affected).
- ★ A whole connector wire shall be used for indoor/outdoor unit as required in the operation specification of installation process and operation instructions.

Minimum Room Area

Type	LFL kg/m ³	Total Mass Charged/kg Minimum Room Area/m ²						
		1.224	1.836	2.448	3.672	4.896	6.12	7.956
R32	0.306							
			3	6	13	23	36	60

The maximum refrigerant charge amount (M)

Unit model	M kg	Unit model	M kg	Unit model	M kg	Unit model	M kg
1U20YEEFRA	0.62	1U25S2SM1FA	0.85	1U35MEEFRA	0.82	1U50JEFFRA-TCS	1.35
1U25BEEFRA	0.74	1U25YEMFRA	0.67	1U35S2PJ1FA	1.15	1U50MEE/MFRA	1.30
1U25BEFFRA	0.90	1U35BEEFRA	0.82	1U35S2SM1FA	1.14	1U50S2SJ2FA	1.35
1U25BEFFRA-TCS	0.90	1U35BEEFRA-TCS	0.82	1U35YEMFRA	0.70	1U68REE/F/MFRA	1.60
1U25S2PJ1FA	1.15	1U35BEFFRA	0.92	1U50JEFFRA	1.35	1U71S2SR1FA	1.60
1U42S2SM1FA	1.14	1U50S2PR1FA	1.60	1U25JEJFRA	0.94	1U35JEJFRA	0.94
1U50REJFRA	1.60	1U71REAFRA	1.60	1U71RECFRA	1.60		

- **Safety Awareness**

1. Procedures: operation shall be made as per controlled procedures to minimize the probability of risks.
2. Area: area shall be divided and isolated appropriately, and operation in an enclosed space shall be avoided. Before the refrigeration system is started or before hot working, ventilation or opening of the area shall be guaranteed.
3. Site inspection: the refrigerant shall be checked.
4. Fire control: the fire extinguisher shall be placed nearby, and fire source or high temperature is not allowed; the sign of “No smoking” shall be arranged.

- **Unpacking Inspection**

1. Indoor unit: nitrogen is sealed during the delivery of indoor units (inside the evaporator), and the red sign at the top of the green plastic seal cap on the evaporator air pipes of the indoor unit shall be checked first after unpacking. In case the sign is raised, the nitrogen sealed still exists. Afterwards, the black plastic seal cap at the joint of evaporator liquid pipes of the indoor unit shall be pressed, to check whether nitrogen still exists. In case no nitrogen is sprayed out, the indoor unit is subject to leakage, and installation is not allowed.
2. Outdoor unit: the leak detection equipment shall be extended into the packing box of the outdoor unit, to check whether the refrigerant is leaking. If the refrigerant leakage is identified, installation is not allowed, and the outdoor unit shall be delivered to the maintenance department.

- **Inspection on Installation Environment**

1. The room area checked cannot be less than the area specified on the warning sign of the indoor unit.
2. Inspection on the surrounding environment of place of installation: the outdoor unit of flammable refrigerants air conditioner cannot be installed inside an enclosed room reserved.
3. Power supply, switches or other high-temperature articles such as the fire source and oil heater shall be avoided below the indoor unit.
4. The power supply shall be provided with earthing wire and be reliably earthed.
5. While punching the wall with an electric drill, whether embedded water/electricity/gas pipelines are designed at the hole preset by the user shall be verified in advance. It is recommended that the through-wall holes reserved shall be used as much as possible.

- **Safety Principles of Installation**

1. Favorable ventilation shall be maintained at the place of installation (doors and windows are opened).
2. Open fire or high-temperature heat source (including welding, smoking and oven) higher than 548 °C is not allowed within the scope of flammable refrigerant.
3. Anti-static measures shall be taken, such as the wearing of cotton clothes and cotton gloves.
4. The place of installation shall be convenient for installation or maintenance, and cannot be adjacent to heat source and flammable and combustible environment.
5. In case of refrigerant leakage of the indoor unit during installation, the valve of the outdoor unit shall be closed immediately, and windows shall be opened, and all the personnel shall be evacuated. After the leakage of refrigerant is handled, the indoor environment shall be subject to concentration detection. Further handling is not allowed until the safety level is reached.
6. In case the product is damaged, it must be delivered to the maintenance point. Welding of refrigerant pipelines at the user’s site is not allowed.
7. The installation position of air conditioner shall be convenient for installation or maintenance. Barriers shall be avoided around the air inlet/outlet of the indoor/outdoor unit, and the electrical appliance, power switches, sockets, valuables and high-temperature products within the scope of both sidelines of the indoor unit shall be avoided.



No fire source around the place of installation



Cotton clothes



Anti-static gloves



BEWARE
ELECTROSTATICS



Goggles



Read operator’ manual



Read technical manual



Operator’ manual; operating instructions

- **Electrical Safety Requirements**

Note:

1. The surrounding conditions (ambient temperature, direct sunlight and rainwater) shall be noticed during electrical wiring, with effective protective measures being taken.
2. Copper wire cable in line with local standards shall be used as the power line and connector wire.
3. Both the indoor unit and outdoor unit shall be reliably earthed.
4. Wiring for the outdoor unit shall be made first and then the indoor unit. The air conditioner can only be powered on after wiring and pipe connection.
5. The dedicated branch circuit must be used, and leakage protector with sufficient capacity must be installed.

- **Qualification Requirements of Installer**

Relevant qualification certificate must be obtained as per national laws and regulations.

- **Indoor Unit Installation**

1. **Fixation of wall panel and piping layout**

In case of left/right water pipe connection for the indoor unit, or in case the evaporator interface of the indoor unit and the horn mouth of the connecting piping cannot be extended to the outdoor side for installation, the connector pipes shall be connected to the evaporator piping interface of the indoor unit in the process of horn mouth.

2. **Piping layout**

During layout of connecting pipes, drain hose and connector wires, the drain hose and connecting wire shall be placed at the bottom and top respectively. The power line cannot be twined with the connector wire. The drain pipes (especially inside the room and machine) must be winded with thermal insulation materials.

3. **Nitrogen charging for pressure maintaining and leak detection**

After the evaporator of the indoor unit is connected to the connector pipe (after welding), nitrogen more than 4.0MPa shall be charged inside the evaporator and the piping connected to evaporator with a nitrogen cylinder (adjusted by a reducing valve). Afterwards, the valve of the nitrogen cylinder shall be closed, for leak detection with soapy water or leak detecting solution. The pressure shall be maintained for more than 5 minutes, and then whether the system pressure is reduced or not shall be observed. In case the pressure is reduced, leakage can be identified. After the leak point is handled, the steps above shall be repeated.

After the evaporator of the indoor unit is connected to connecting piping, nitrogen shall be charged for pressure maintaining and leak detection. Afterwards, the evaporator shall be connected to the two-way stop valve and three-way stop valve of the outdoor unit. After the copper cap of the connecting piping is fastened, nitrogen more than 4.0MPa shall be charged at the access hole of the three-way stop valve with a charging hose. The valve of the nitrogen cylinder shall be closed, for leak detection with soapy water or leak detecting solution. The pressure shall be maintained for more than 5 minutes, and then whether the system pressure is reduced or not shall be observed. In case the pressure is reduced, leakage can be identified. After the leak point is handled, the steps above shall be repeated.

The operation above can also be completed after the indoor unit is connected to the connecting pipelines and the two-way stop valve and three-way stop valve of the outdoor unit, after the access hole of the outdoor unit is connected to the nitrogen cylinder and pressure gauge and after more than 4.0MPa nitrogen is charged. No leak points are identified in the leak detection at the joint/welding junction of the indoor unit and at the joint of connecting pipelines of the two-way stop valve and three-way stop valve of the outdoor unit. It must be guaranteed that each joint is available for leak detection during installation.

The next step (vacuumizing with a vacuum pump) can only be continued after the installation steps (nitrogen charging for pressure maintaining and leak detection normal) are completed.

- **Outdoor Unit Installation**

1. **Fixation and connection**

Note:

- a) Fire source shall be avoided within 3m around the place of installation.
- b) The leak detection equipment of refrigerant shall be placed at a low position in the outdoor, and shall be opened.



1) Fixation

The support of the outdoor unit shall be fixed onto the wall surface, and then the outdoor unit shall be fixed onto the support horizontally. In case the outdoor unit is wall-mounted or roof-mounted, the support shall be firmly fixed, to avoid the damage of strong wind.

2) Installation of connecting pipes

The cone of the connecting pipes shall be aligned with the conical surface of corresponding valve connector.

The nut of connecting pipes shall be installed at a proper position and then be tightened with a spanner. Excessive tightening torque shall be avoided, or otherwise the nut may be damaged.

- **Vacuumizing**

A digital vacuum gauge shall be connected for vacuumizing. The duration of vacuumizing shall be at least 15 minutes, and the pressure of the vacuum gauge shall be below 60Pa. Afterwards, the vacuumizing equipment shall be closed, and whether the reading of the digital vacuum gauge is increased or not shall be observed after the pressure is maintained for 5 minutes. In case no leakage is identified, the two-way stop valve and three-way stop valve of the outdoor unit may be opened. Finally, the vacuumizing hose connected to the outdoor unit can be disassembled.

- **Leak Detection**

The joint of connecting pipes for the outdoor unit shall be subject to leak detection with soap bubble or dedicated leak detection equipment.

- **Post-installation Inspection Items and Test Run**

Post-installation Inspection Items

Items to Be Checked	Consequence of Improper Installation
Whether the installation is firm or not	The unit may fall, vibrate or make a noise
Whether the inspection on air leakage is completed	The refrigerating capacity (heating capacity) may be insufficient
Whether the unit is fully insulated	Condensation or drip may occur
Whether the drainage is smooth or not	Condensation or drip may occur
Whether the power voltage is identical to that marked on the nameplate	Failure may occur or the parts may be burned
Whether the circuit and pipeline are installed correctly	Failure may occur or the parts may be burned
Whether the unit is safely earthed	Electric leakage may occur
Whether the type of wire is in line with relevant regulations	Failure may occur or the parts may be burned
Whether barriers are identified at the air inlet/outlet of the indoor/outdoor unit	The refrigerating capacity (heating capacity) may be insufficient
Whether the length of refrigerant pipes and the refrigerant amount charged are recorded	The refrigerant amount charged cannot be confirmed

Test Run

1. Preparations

- (1) Power on is not allowed before all the installation operations are completed and before the leak detection is proven qualified.
- (2) The control circuit shall be connected correctly and all the wires shall be firmly connected.
- (3) The two-way stop valve and three-way stop valve shall be opened.
- (4) All the scattered articles (especially the metal filing and thread residue) shall be removed from the unit body.

2. Methods

- (1) Switch on the power supply and press the "ON/OFF" on the remote controller, after which the air conditioner will start operating.
- (2) Press "Mode" to select refrigeration, heating and sweeping wind, and observe whether the air conditioner is under normal operation.

Relocation Procedures

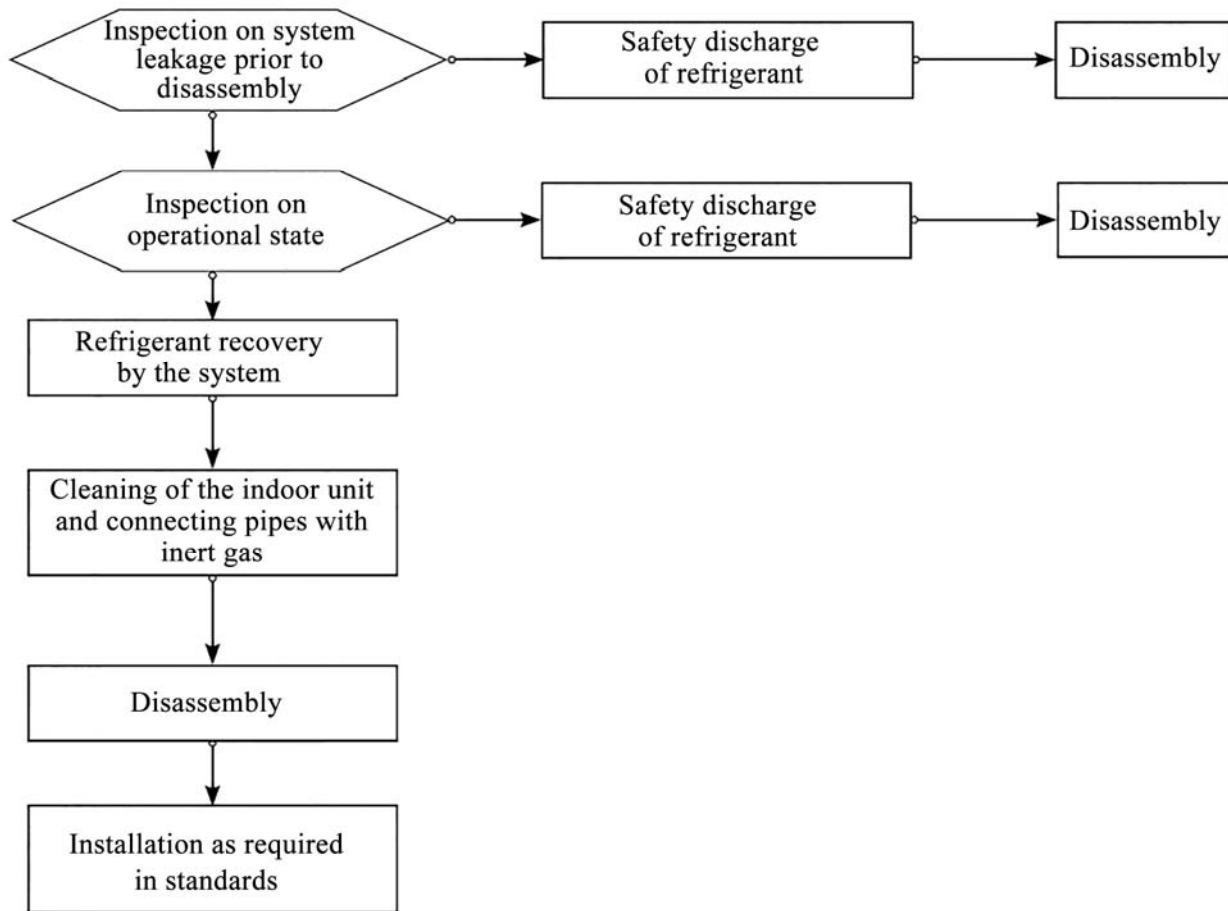

Note: in case relocation is required, the joint of evaporator gas/liquid pipes of the indoor unit shall be cut off with a cutting knife. Connection is only allowed after re-flaring (the same to the outdoor unit).

Maintenance Instructions

Maintenance Precautions

Precautions

- For all the faults requiring welding the refrigeration pipelines or components inside the refrigeration system of R32 refrigerant air conditioners, maintenance at the user's site is never allowed.
- For the faults requiring radical disassembly and bending operation of the heat exchanger, such as the replacement of the outdoor unit chassis and integral disassembly of the condenser, inspection and maintenance at the user's site are never allowed.
- For the faults requiring replacement of the compressor or parts & components of refrigeration system, maintenance at the user's site is not allowed.
- For other faults not involved in the refrigerant container, internal refrigeration pipelines and refrigeration elements, the maintenance at the user's site is allowed, including the cleaning and dredging of the refrigeration system requiring no disassembly of refrigeration elements and no welding.
- In case replacement of gas/liquid pipes is required during maintenance, the joint of evaporator gas/liquid pipes of the indoor unit shall be cut off with a cutting knife. Connection is only allowed after re-flaring (the same to the outdoor unit).

Qualification Requirements of Maintenance Personnel

1. All the operators or the maintenance personnel involved in refrigerating circuits shall be provided with the effective certificate issued by an industry-accepted assessment institute, to ensure that they are qualified for safety disposal of refrigerant as required in the assessment regulations.
2. The equipment can only be maintained and repaired as per the method recommended by the manufacturer. In case the assistance from personnel of other disciplines is required, the assistance shall be supervised by the personnel with qualification certificate involved in flammable refrigerant.

Inspection on Maintenance Environment

- Before operation, the refrigerant leaked in the room is not allowed.
- The area of the room in which maintenance is made shall be in line with the nameplate.
- Continuous ventilation shall be maintained during maintenance.
- Open fire or high-temperature heat source higher than 548 degree which can easily give birth to open fire is not allowed inside the room within the maintenance area.
- During maintenance, the phones and the radioactive electronics of all the operators inside the room must be powered off.
- One dry powder or carbon dioxide extinguisher shall be equipped inside the maintenance area, and the extinguisher must be under available state.

Maintenance Site Requirements

- The maintenance site shall be provided with favorable ventilation and must be flat. Arrangement of the maintenance site inside the basement is not allowed.
- Welding zone and non-welding zone shall be divided at the maintenance site, and shall be clearly marked. A certain safety distance must be guaranteed between the two zones.
- Ventilators shall be installed at the maintenance site, and exhaust fans, fans, ceiling fans, floor fans and dedicated exhaust duct can be arranged, to meet the requirements of ventilation volume and uniform exhaust, and to avoid accumulation of refrigerant gas.
- Leak detection equipment for flammable refrigerant shall be equipped, with relevant management system being established. Whether the leak detection equipment is under available state shall be confirmed before maintenance.
- Sufficient dedicated vacuum pumps of flammable refrigerant and refrigerant charging equipment shall be equipped, with relevant management system for maintenance equipment being established. It shall be guaranteed that the maintenance equipment can only be used for vacuumizing and charging of one type of flammable refrigerant, and mixed usage is not allowed.
- The master power switch shall be arranged outside the maintenance site, with protective (anti-explosive) device being equipped.
- Nitrogen cylinders, acetylene cylinders and oxygen cylinders shall be placed separately. The distance between the gas cylinders above and the working area involved in open fire shall be at least 6m. The anti-backfire valve shall be installed for the acetylene cylinders. The color of the acetylene cylinders and oxygen cylinders installed shall meet the international requirements.
- The warning sign of “No Fire” shall be arranged inside the maintenance area.
- Fire control device suitable for electric appliance such as the dry powder extinguisher or carbon dioxide extinguisher shall be equipped, and shall always be under the available state.
- The ventilator and other electrical equipment at the maintenance site shall be relatively fixed, with standardized pipe routing. Temporary wires and sockets at the maintenance site are not allowed.

Leak Detection Methods

- The environment in which the refrigerant leakage is checked shall be free from potential ignition source. Leak detection with halogen probes (or any other detector with open fire) shall be avoided.
- For the system containing flammable refrigerant, leak detection may be realized with electronic leak detection equipment. During leak detection, the environment in which the leak detection equipment is calibrated shall be free from refrigerant. It shall be guaranteed that the leak detection equipment will not become potential ignition source, and is applicable to the refrigerant to be detected. Leak detection equipment shall be set at a percentage of the LFL of the refrigerant and shall be calibrated to the refrigerant employed, and the appropriate percentage of gas (25 % maximum) is confirmed.
- The fluid used for leak detection shall be applicable to most of the refrigerant. The use of chlorine-containing solvent shall be avoided, to avoid chemical reaction between chlorine and refrigerant and corrosion to copper pipelines.
- In case leakage is suspected, the open fire at the site shall be evacuated or be put out.
- In case welding is required at the leakage position, all the refrigerants shall be recovered, or be isolated at a position far from the leak point with a stop valve. Before and during welding, the whole system shall be purified with OFN.

Safety Principles

- During product maintenance, favorable ventilation shall be guaranteed at the maintenance site, and the close of all the doors/windows is not allowed.
- Operation with open fire is not allowed, including welding and smoking. The use of phones is also not allowed. The user shall be informed that cooking with open fire is not allowed.
- During maintenance in a dry season, when the relative humidity is less than 40%, anti-static measures shall be taken, including the wearing of cotton clothes and cotton gloves.
- In case the leakage of flammable refrigerant is identified during maintenance, forced ventilation measures shall be taken immediately, and the source of leak shall be plugged.
- In case the product damaged must be maintained by disassembling the refrigeration system, the product must be delivered to the maintenance point. Welding of refrigerant pipelines at the user's site is not allowed.
- During maintenance, in case re-treatment is required due to lack of fittings, the air conditioner shall be reset.
- The refrigeration system must be safely earthed in the whole course of maintenance.
- For the door-to-door service with refrigerant cylinders, the refrigerant charged inside the cylinder cannot exceed the specified value. The cylinder placed in vehicles or at the installation/maintenance site shall be fixed perpendicularly and be kept away from heat sources, ignition source, source of radiation and electric appliance.

Maintenance Items

Maintenance Requirements

- Before the refrigeration system is operated, the circulating system shall be cleaned with nitrogen. Afterwards, the outdoor unit shall be vacuumized, the duration of which cannot be less than 30 minutes. Finally, 1.5~2.0MPa OFN shall be used for nitrogen flushing (30 seconds~1 minute), to confirm the position requiring treatment. Maintenance of the refrigeration system is only allowed after the residual gas of flammable refrigerant is removed.
- During the use of refrigerant charging tools, cross contamination of different refrigerants shall be avoided. The total length (including the refrigerant pipelines) shall be shortened as much as possible, to reduce the residual of refrigerant inside.
- The cylinders of refrigerant shall be kept upright, and be fixed.
- Before refrigerant charging, the refrigeration system shall be earthed.
- The refrigerant charged shall be of the type and volume specified on the nameplate. Excessive charging is not allowed.
- After maintenance of the refrigeration system, the system shall be sealed with a safe manner.
- The maintenance in progress shall not damage or lower the original class of safety protection of the system.

Maintenance of Electrical Components

- Partial of the electrical component under maintenance shall be subject to inspection on refrigerant leakage with dedicated leak detection equipment.
- After the maintenance, the components with safety protection functions cannot be disassembled or removed.
- During the maintenance of sealing elements, before opening the seal cover, the air conditioner shall be powered off first. When power supply is required, continuous leak detection shall be carried out at the most dangerous position, to avoid potential risks.
- During maintenance of electrical components, the replacement of enclosures shall not affect the level of protection.
- After maintenance, it shall be guaranteed that the sealing functions will not be damaged or the sealing materials will not lose the function of preventing the entry of flammable gas due to aging. The substitute components shall meet the recommended requirements of the air conditioner manufacturer.

Maintenance of Intrinsically Safe Elements

The intrinsically safe element refers to the components working continuously inside flammable gas without any risks.

- Before any maintenance, leak detection and inspection on earthing reliability of the air conditioner must be carried out, to ensure no leakage and reliable earthing.
- In case the allowable voltage and current limit may be surpassed during the service of the air conditioner, any inductance or capacitance cannot be added in the circuit.
- Only the elements appointed by the air conditioner manufacturer can be used as the parts and components replaced, or otherwise a fire may be triggered in case of refrigerant leakage.
- For the maintenance not involved in system pipelines, the system pipelines shall be well protected, to ensure that no leakage will be caused due to maintenance.
- After maintenance and before test run, the air conditioner must be subject to leak detection and inspection on earthing reliability with leak detection equipment or leak detecting solution. It shall be guaranteed that the startup inspection is carried out without leakage and under reliable earthing.

Removal and Vacuumizing

The maintenance or other operations of the refrigeration circuit shall be made as per conventional procedures. Moreover, the flammability of refrigerant shall also be mainly considered. The following procedures shall be followed:

- Refrigerant clearing;
- Pipeline purification with inert gas;
- Vacuumizing;
- Pipeline purification again with inert gas;
- Pipeline cutting or welding. The refrigerant shall be recovered to a proper cylinder. The system shall be purged with OFN, to ensure safety. The step above may need to be repeated for several times. Compressed air or oxygen cannot be used for purging.

In the course of purging, OFN shall be charged inside the refrigeration system under vacuum state, to reach the operating pressure. Afterwards, the OFN shall be discharged to the atmosphere. Finally, the system shall be vacuumized. The step above shall be repeated until all the refrigerants in the system are cleared. The OFN charged for the last time shall be discharged to the atmosphere. Afterwards, the system can be welded. The operation above is necessary in case of pipeline welding.

It shall be guaranteed that no alight fire source is around the outlet of the vacuum pump and the ventilation is favorable.

Welding

- Favorable ventilation must be guaranteed in the maintenance area. After the maintenance machine is subject to the vacuumizing above, the system refrigerant can be discharged on the outdoor unit side.
- Before the outdoor unit is welded, it must be guaranteed that no refrigerant is inside the outdoor unit and the system refrigerant has been discharged and cleared.
- The refrigeration pipelines cannot be cut with a welding gun under any circumstance. The refrigeration pipelines must be disassembled with a pipe cutter, and the disassembly must be carried out around a ventilation opening.

Refrigerant Charging Procedures

The following requirements are added as the supplementation of conventional procedures:

- During the use of refrigerant charging tools, cross contamination of different refrigerants shall be avoided. The total length (including the refrigerant pipelines) shall be shortened as much as possible, to reduce the residual of refrigerant inside;
- The cylinders of refrigerant shall be kept upright;
- Before refrigerant charging, the refrigeration system shall be earthed;
- A label must be pasted on the refrigeration system after refrigerant charging;
- Excessive charging is not allowed; the refrigerant shall be charged slowly;
- In case system leakage is identified, refrigerant charging is not allowed unless the leak point is plugged;
- During refrigerant charging, the charging amount shall be measured with an electronic scale or a spring scale. The connecting hose between the refrigerant cylinder and the charging equipment shall be relaxed appropriately, to avoid impact on the measuring accuracy due to stress.

Requirements on storage site of refrigerant

- The cylinder of refrigerant shall be placed in a -10~50°C environment with favorable ventilation, and warning labels shall be pasted;
- The maintenance tool in contact with the refrigerant shall be stored and used separately, and the maintenance tool of different refrigerants cannot be mixed.

Scrapping and Recovery

Scrapping

Before scrapping, the technician shall be completely familiar with the equipment and all its features. The safe recovery of refrigerant is recommended. In case the refrigerant recovered needs to be reused, before which the sample of refrigerant and oil shall be analyzed. The power supply required shall be guaranteed before tests.

- (1) The equipment and operation shall be well known;
- (2) Power supply shall be switched off;
- (3) The followings shall be guaranteed before scrapping:
 - The mechanical equipment shall be convenient for operation on the cylinder of refrigerant (if necessary);
 - All personal protective equipment is available and being used correctly;
 - The whole course of recovery shall be guided by qualified personnel;
 - The recovery equipment and cylinders shall be in line with corresponding standards.
- (4) The refrigeration system shall be vacuumized if possible;

- (5) In case the vacuum state cannot be reached, vacuumizing shall be carried out from numerous positions, to pump the refrigerant in each part of the system out;
- (6) It shall be guaranteed that the capacity of cylinders is sufficient before recovery;
- (7) The recovery equipment shall be started and operated as per the operation instructions of the manufacturer;
- (8) The cylinder cannot be charged too full. (The refrigerant charged cannot exceed 80% of the capacity of cylinders)
- (9) The maximum operating pressure of cylinders cannot be surpassed even only lasting for a short term;
- (10) After refrigerant charging is completed, the cylinder and equipment must be evacuated rapidly, and all the stop valves on the equipment must be closed;
- (11) Before purification and tests, the refrigerant recovered cannot be charged into another refrigeration system.

Note:

The air conditioner shall be marked (with dates and signature) after being scrapped and the refrigerant is discharged. It shall be guaranteed that the sign on the air conditioner can reflect the flammable refrigerant charged inside.

Recovery

During maintenance or scrapping, the refrigerant inside the refrigeration system needs to be cleared. It is recommended that the refrigerant be cleared thoroughly.

The refrigerant can only be charged into a dedicated cylinder, the capacity of which shall match with the refrigerant amount charged in the whole refrigeration system. All cylinders to be used are designated for the recovered refrigerant and labeled for that refrigerant (Dedicated Cylinder for Refrigerant Recovery). The cylinders shall be equipped with pressure relief valves and stop valves under favorable state. The empty cylinder shall be vacuumized before usage and be kept under normal temperature if possible.

The recovery equipment shall always be under favorable working state, and be equipped with operation instructions, to facilitate information search. The recovery equipment shall be applicable to the recovery of flammable refrigerant. Moreover, weighing apparatus under available state with measurement certificates shall be equipped. In addition, removable attachment joints free from leakage shall be used as the hose, and shall always be under favorable state. Whether the recovery equipment is under favorable state and is properly maintained and whether all the electrical components are sealed shall be checked before usage, to avoid fire in case of refrigerant leakage. If you have any question, please consult the manufacturer.

The refrigerant recovered shall be delivered back to the manufacturer in appropriate cylinders, with transporting instructions being attached. Mixing of refrigerant in recovery equipment (especially the cylinders) is not allowed.

During transporting, the space in which the flammable refrigerant air conditioners are loaded cannot be sealed. Anti-static measures shall be taken for the transporting vehicles if necessary. Meanwhile, during the transporting, loading and unloading of air conditioners, necessary protective measures shall be taken, to protect the air conditioner from being damaged.

During removal of the compressor or clearing of the compressor oil, it shall be guaranteed that the compressor is vacuumized to a proper level, to ensure no residual flammable refrigerant is left inside the lubricating oil. The vacuumizing shall be completed before the compressor is delivered back to the manufacturer. The vacuumizing can only be accelerated by heating the compressor housing through electrical heating. Safety shall be guaranteed when the oil is discharged from the system.

Parts and Functions

Indoor Unit

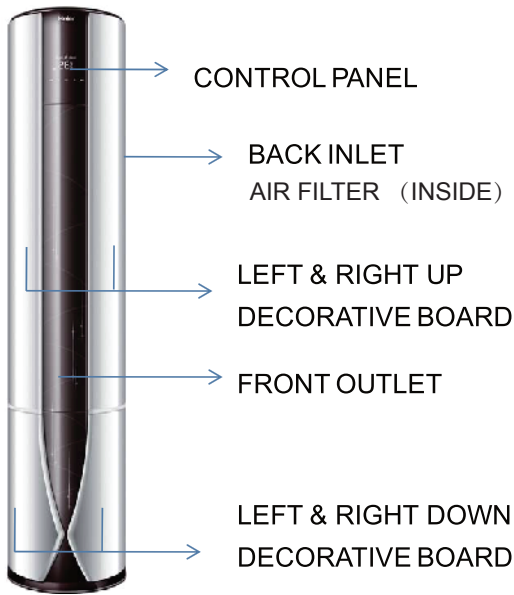

Display board

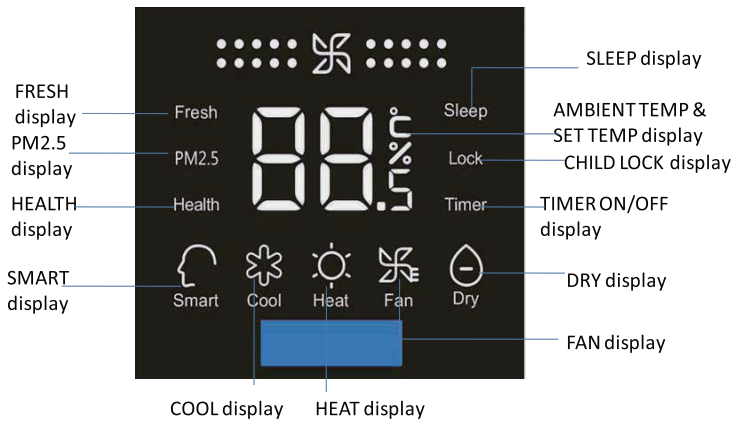

Note: Fresh function is not available on this model.

Outdoor Unit

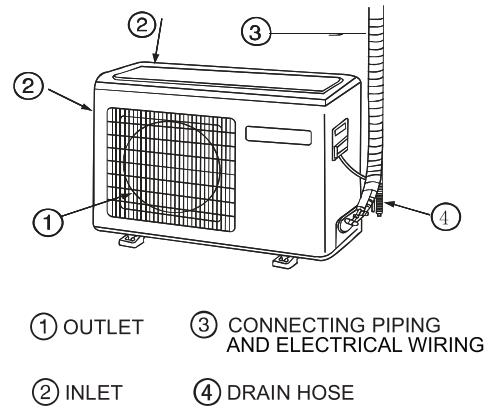

Remote controller

Outer side of the controller

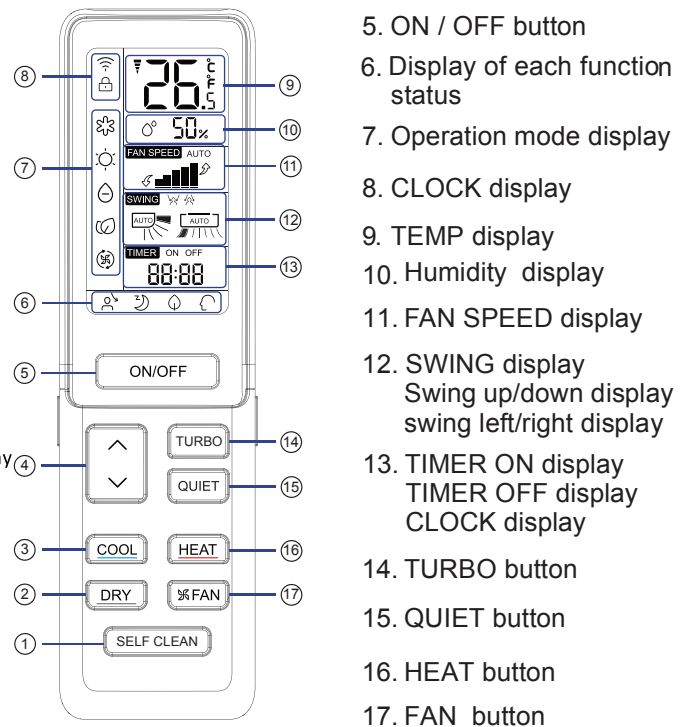

1. SELF CLEAN button
2. DRY button
Used to set DRY operation.
3. COOL button
Used to set COOL operation.
4. TEMP button
used to change setting temperature

NOTICE:
Humidity display is unavailable on this model.

Operation

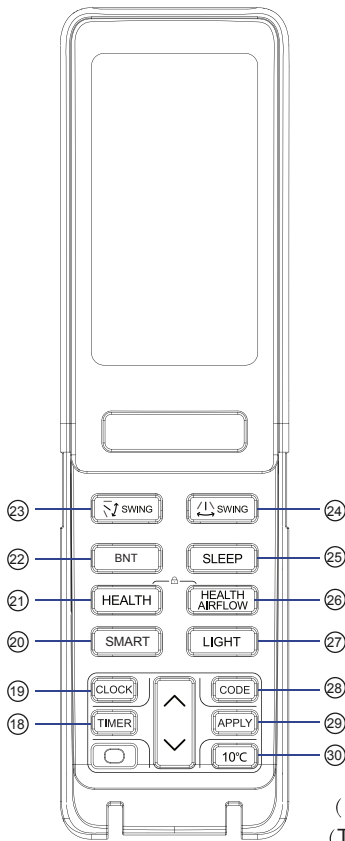

18. TIMER button
19. CLOCK button
20. SMART button
Used to set SMART operation.
21. HEALTH button
(Press the HEALTH button in the shutdown state to enter Fan mode)
22. BNT button
(BNT function is not available)
23. SWING up/down button
24. SWING left/right button
25. SLEEP button
26. HEALTH AIRFLOW button
27. LIGHT button
Control the lightening and extinguishing of the indoor LED display board.
28. CODE button
A-b yard(Only A yard is available)
29. APPLY button
30. 10°C button
special heating set function: 10 degree heating maintaining
(This function is unavailable on this model)

Press "HEALTH"+"HEALTH AIRFLOW" simultaneously can set and cancel the "LOCK" function ()

Clock set

- 1 Press CLOCK button,
- 2 Press "+" or "-" to set correct time.
- 3 Confirm time.

Each press will increase or decrease 1min. If the button is kept pressed, time will change quickly.

After time setting is confirmed, press APPLY, "

The distance between the signal transmission head and the receiver hole should be within 7m without any obstacle as well. When electronic-started type fluorescent lamp or change-over wireless telephone is installed in the type fluorescent lamp or room, the receiver is apt to be disturbed in receiving the signals, so the distance to the indoor unit should be shorter.

Full display or unclear display during operation indicates the batteries have been used up. Please change batteries. If the remote controller can't run normally during operation, please remove the batteries and reload several minutes later

Hint:

1. Use the new battery with the same two models.
2. When the remote control is abnormal during use, please remove the battery and put the battery iback after a few minutes.
3. If the remote control appears dimmed (sometimes abnormal state), it means that the power has run out, please replace the battery.
4. Please dispose of waste batteries properly.
5. Remove the batteries in case unit won't be in usage for a long period.

NOTICE:

1. The signal transmitting head is aligned with the signal receiving window on the indoor machine.
2. The transmitting head and the receiving window are within seven meters and there should be no obstructions in the middle.

3. Do not throw and drop the remote control.
4. When the room has an electronic start-up fluorescent lamp or a converted fluorescent lamp or a wireless telephone, the signal will be disturbed, and the distance between the remote control and the indoor unit will be kept close to the use.

Operation

TURBO/QUIET Operation

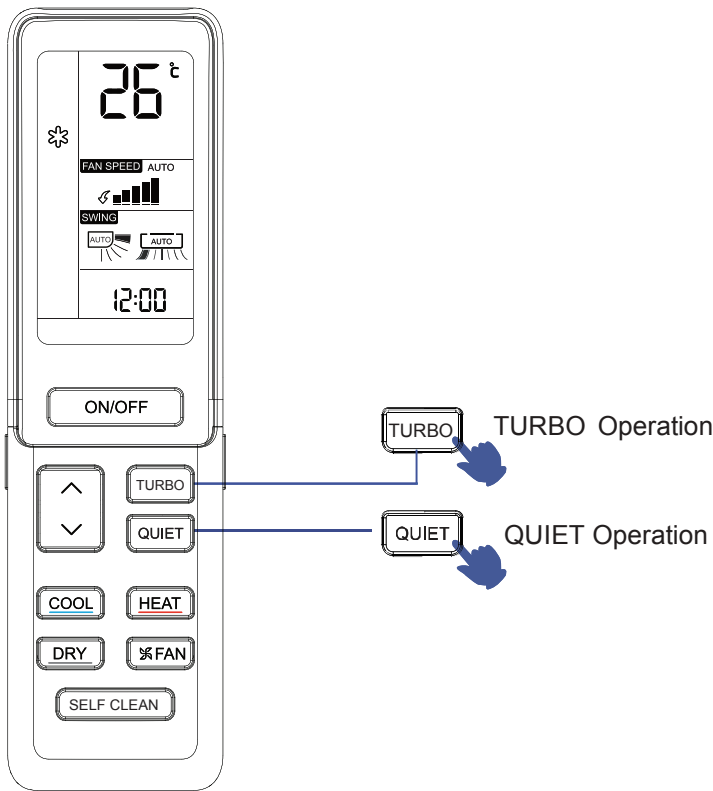

QUIET Operation:

You can use this function when silence is needed for rest or reading.

For each press,  is displayed, Air conditioner starts QUIET function operation. In QUIET operation mode, fan speed automatically takes low speed of AUTO fan mode.

Press QUIET button again,  disappears, the operation stops.

TURBO Operation:

When you need rapid cooling, you can use this function.

Press TURBO button, the remote controller will show , and then achieve to the turbo function. Press again this TURBO button, the turbo function will be cancelled.

Note :

During TURBO operation, in rapid COOL mode, the room will show inhomogeneous temperature distribution.

COOL, HEAT and DRY Operation

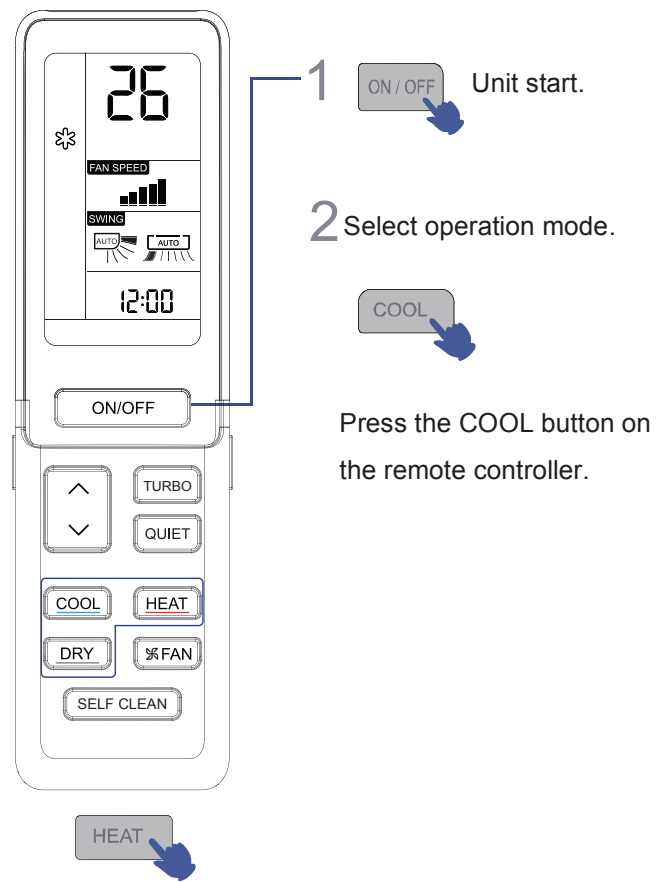

Press the HEAT button on the remote controller.



Press the DRY button on the remote controller.

Hint:

1. In DRY mode, when room temperature becomes lower than temp. setting +2 °C, unit will run intermittently at LOW speed regardless of FAN setting.
2. Remote controller can memorize each operation status. When starting it next time, just press ON/OFF button and unit will run in previous status.

Operation

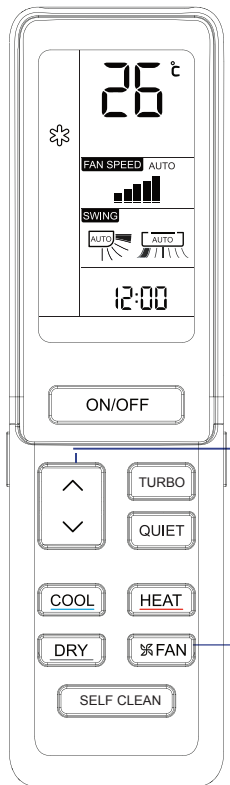

- 1 Press TEMP button.
 - △ Every time the button is pressed, temp. setting increases 1°C.
 - ▽ Every time the button is pressed, temp. setting decreases 1°C.

Hint:

You can control the unit temp. by the panel "<" ">" independently. Every time the button is pressed, temp. setting increases/ decreases 0.5°C.

The range of setting temperature is 16 -30 .

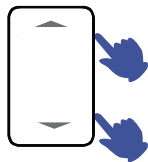

Unit will start running to reach the temp. setting on LCD.

2

FAN Operation



Press FAN SPEED button. For each press, fan speed changes as follows:

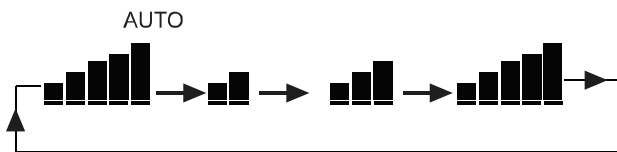

Unit will run at selected fan speed.

Comfortable SLEEP

Before going to bed, you can simply press the SLEEP button and unit will operate in SLEEP mode and bring you a sound sleep.

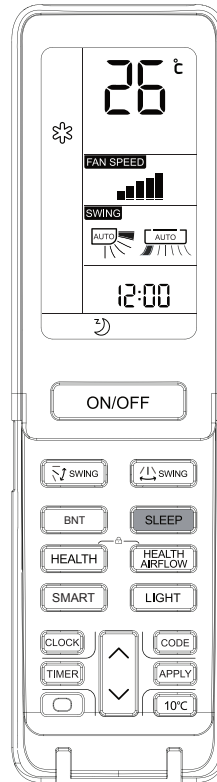

Press SLEEP button.

Operation Mode

1. When the sleeping signal is received, the air conditioner runs according to the system's preset sleep temperature curve.
2. After setting the SLEEP mode, if the setting temperature is adjusted manually, the temperature will be operated according to the manual setting.
3. In SMART mode
The unit operates in corresponding sleep mode adapted to the automatically selected operation mode
4. In FAN mode
It has no SLEEP function.
5. Set the SLEEP mode, the air conditioner will automatically shut down after 8 hours.

Operation

SELF CLEAN Operation

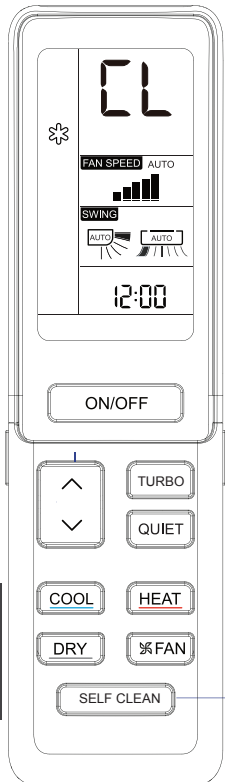

SELF CLEAN Operation

- ◆ Functional description: the purpose of this function is to clean the evaporator and the condenser.
- ◆ Entry and exit: Press self clean button to enter this function, then it will display "CL" on the panel of the indoor unit and also on the remote controller. After running 20-30 minutes, this function will exit automatically with the " Pi " sound is heard twice, then the unit return to original state. Under operation process of self clean, press the button repeatedly has no effect and cannot exit, but the power off button and other mode button can make it exit.

Hint:

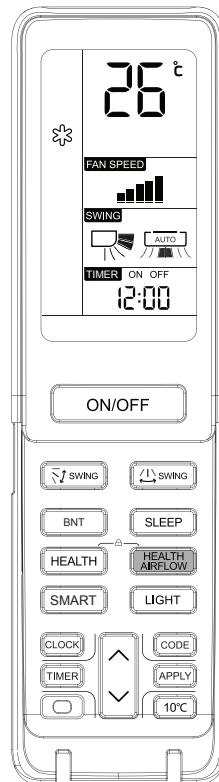

1. It has no effect under the mode of timer/sleep.
2. After this mode starts, the air volume may reduce or even have no airflow.
3. It is normal if the unit make some sound like expand with heat and contract with cold
4. The "CL" display time may last differently on the remote controller and panel.
5. During the self clean process of the outdoor unit, in order to dry the evaporator, it's normal the air conditioner would blow out hot air occasionally.
6. The self clean effect would be affected by the using environment. If the cleaning effect is not achieved, please restart the function after the interval of time.
7. When exit the self clean mode, the water vapor would accoured occasionally.
8. If the temperature is below 5°C outside, the unit would only do the indoor self clean.

HEALTH AIRFLOW Operation



HEALTH AIRFLOW

The setting of health airflow function

- 1). Press the button of health airflow,  appears on the display. Avoid the strong airflow blows direct to the body.
- 2). Press the button of health airflow again,  appears on the display. Avoid the strong airflow blows direct to the body.

HEALTH AIRFLOW

The cancel of the health airflow function

Press the button of health airflow again, the outlet grilles of the air conditioner are opened, and the unit goes on working under the condition before the setting of health airflow function. After stopping, the outlet grille will close automatically.



Cannot pull direct the outlet grille by hand. Otherwise, the grille will run incorrectly. If the grille is not run correctly, stop for a minute and then start, adjusting by remote controller.

Remote controller can memorize each operation status. when starting it next time, just press ON/OFF button and unit will run in previous status.

Hint:

Fan mode, the default wind speed is low, and temperature setting value does not display. You can switch to other mode in order to quit this mode.

NOTICE:

1. After setting the health airflow function, the position of outlet grilles is fixed.
2. In heating, it is better to select the  mode.
3. In cooling, it is better to select the  mode.
4. In cooling and dry, using the air conditioner for a long time under the high air humidity, a phenomenon falling drips of water occurs at the outlet grille.
5. Select the appropriate fan direction according to the actual conditions.

Operation

SWING Operation

1 Up and down air flow direction

For each press of “” button, air flow direction on remote controller displays as follows according to different operation modes:

COOL/DRY:

HEAT:

SMART:

Initial state

2 Left and right air flow direction

For each press of “” button, remote controller displays as follows:

remote controller:

Put leaf:

Initial state

Hint:

1. When humidity is high, condensate water might occur at air outlet if all vertical louvers are adjusted to left or right.
2. It is advisable not to keep horizontal flap at downward position for a long time in COOL or DRY mode, otherwise, condensate water might occur.
3. As cold air flows downward in COOL mode, adjusting air flow horizontally will be much more helpful for a better air circulation

TIMER Operation

Set Clock correctly before starting Timer operation. You can let unit start or stop automatically a following times: Before you wake up in the morning, or get back from outside or after you fall asleep at night.

1 Select your desired operation mode.

Select your desired **TIMER ON**.

Remote controller: “**TIMER ON**” will flash.

Select your desired **TIMER OFF**.

Remote controller: “**TIMER OFF**” will flash.

2 Time setting.

Every time the button is pressed, time setting increases or decreases 1 min, if kept depressed, it will increase rapidly. It can be adjusted within 24 hours.

3 Confirming your setting.

After setting correct time, press **APPLY** button to confirm “**ON**” or “**OFF**” on the remote controller stops flashing.

Hint:

To cancel **TIMER** mode
Just press **TIMER** button several times until **TIMER** display disappear.

Operation

SMART Operation

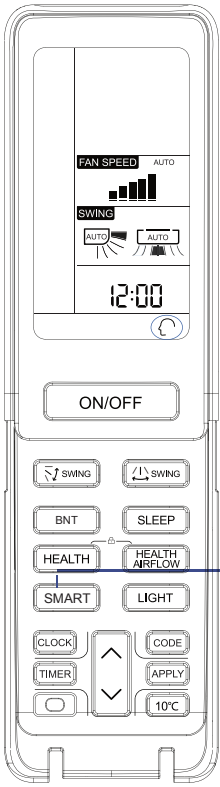

One key can give you a comfortable room!
The air conditioning unit can judge the indoor temperature and humidity, and make the adjustment accordingly.

SMART SMART start

Press ON/OFF button, unit starts.
Press SMART button “” is displayed on the remote controller.

- SMART Defrost
- SMART FAN SPEED
- SMART FAN HEALTH
- SMART SOFT
- SMART Control temperature

SMART or **ON/OFF** SMART stops

Hint:

Under the COOL, HEAT and DRY mode, press the smart key to enter the smart function. Under the smart running mode, when the air conditioning is running, it will automatically select COOL, HEAT, DRY or FAN mode as When the smart function is running, press the “COOL” “HEAT” or “DRY” key to switch to the other mode, you will exit from the smart function.

HEALTH Operation

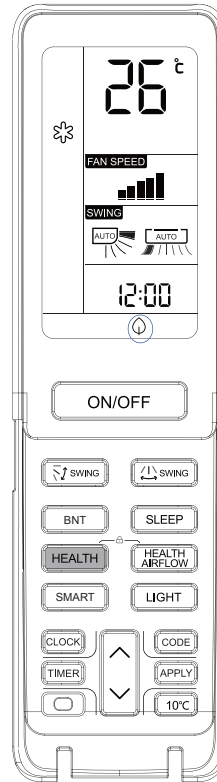

The anion generator in the air conditioner can generate a lot of anion effectively balance the quantity of position and anion in the air and also to kill bacteria and speed up the dust sediment in the room and finally clean the air in the room.

- Press the HEALTH button in the shutdown state to enter Fan mode.

- Press the HEALTH button in the power on state to turn on Health function.

HEALTH Press HEALTH button

For each press,  is displayed
Air conditioner starts health anion function operation.

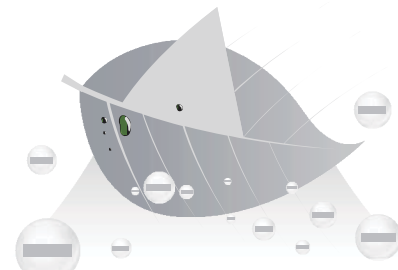

Healthy Negative ions

HEALTH

Press HEALTH button,  disappears, the operation stops.

Hint:

When indoor fan motor is running, it has healthy process function. (It's available under any mode)
When the fan in the indoor unit does not work, the health lamp lights up, but the anion generator does not release anion.

Operation

For Smart Use of the Air Conditioner

Air Filter cleaning

1. Close the unit and turn off the power.
2. Remove the filter as shown in the below picture
3. Clean the filter

Use a vacuum cleaner to remove dust, or wash the filter with water. after washing, dry the filter completely in the shade.

⚠ Caution

1. If the filter is not cleaned in time, it will not only cause the air conditioner to degrade, but also cause the fault.
2. Recommended: Clean the filter once per two weeks.
3. There are four filters in this indoor unit.
4. Do not use hot water above 40° to clean the filter, otherwise it will damage. Carefully wipe the filter screen.

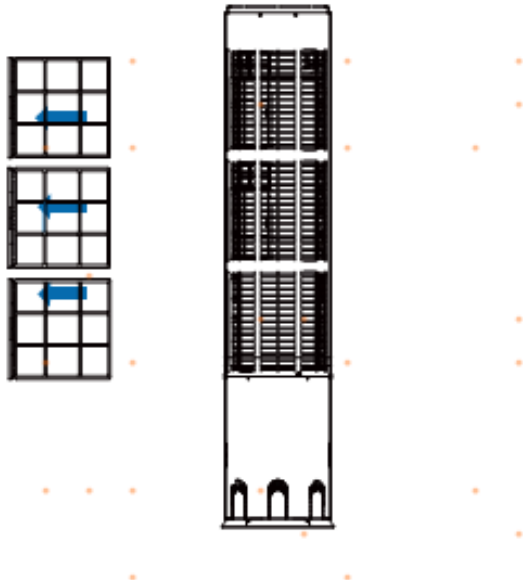

IMPORTANT INFORMATION REGARDING THE REFRIGERANT USED

Contains fluorinated greenhouse gases covered by the Kyoto Protocol		A
R32	1= <input type="text"/> kg	B
	2= <input type="text"/> kg	C
	1+2= <input type="text"/> kg	D
		E
		F

This product contains fluorinated greenhouse gases covered by the Kyoto Protocol. Do not vent into the atmosphere.

Refrigerant type: R32

GWP* value: 675

GWP=global warming potential

Please fill in with indelible ink,

- 1 the factory refrigerant charge of the product
- 2 the additional refrigerant amount charged in the field and
- 1+2 the total refrigerant charge

on the refrigerant charge label supplied with the product. The filled out label must be adhered in the proximity of the product charging port (e.g. onto the inside of the stop valve cover).

A contains fluorinated greenhouse gases covered by the Kyoto Protocol

B factory refrigerant charge of the product: see unit name plate

C additional refrigerant amount charged in the field

D total refrigerant charge

E outdoor unit

F refrigerant cylinder and manifold for charging

Cautions

⚠ WARNING

Please call Sales/Service Shop for the Installation.

Do not attempt to install the air conditioner by yourself because improper works may cause electric shock, fire, water leakage.

⚠ WARNING

When abnormality such as burnt-smell found, immediately stop the operation button and contact sales shop.

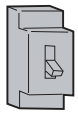

OFF



!
STRICT
ENFORCEMENT

Use an exclusive power source with a circuit breaker

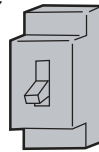

Check proper installation of the drainage securely



STRICT
ENFORCEMENT

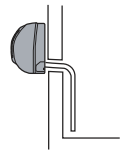

Connect power supply cord to the outlet completely



STRICT
ENFORCEMENT

Use the proper voltage



STRICT
ENFORCEMENT

1. Do not use power supply cord extended or connected in halfway
2. Do not install in the place where there is any possibility of inflammable gas leakage around the unit.
3. Do not get the unit exposed to vapor or oil steam.



PROHIBITION

Do not use power supply cord in a bundle.



PROHIBITION

Take care not to damage the power supply cord.



PROHIBITION

Do not insert objects into the air inlet or outlet.

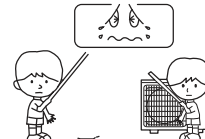

PROHIBITION

Do not start or stop the operation by disconnecting the power supply cord and so on.



PROHIBITION

Do not channel the air flow directly at people, especially at infants or the aged.

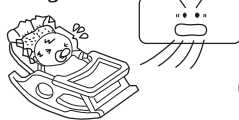

PROHIBITION

Do not try to repair or reconstruct by yourself.

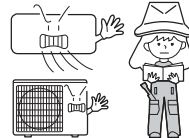

Connect the earth cable.

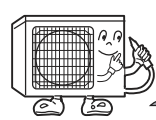

earthing

⚠ CAUTION

Do not use for the purpose of storage of food, art work, precise equipment, breeding, or cultivation.

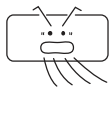

PROHIBITION

Take fresh air occasionally especially when gas appliance is running at the same time.

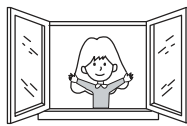

STRICT
ENFORCEMENT

Do not operate the switch with wet hand.

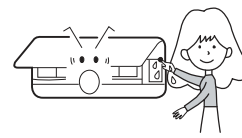

PROHIBITION

Do not install the unit near a fireplace or other heating apparatus.

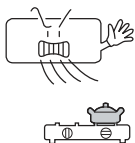

PROHIBITION

Check good condition of the installation stand

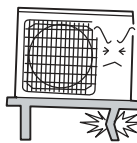

PROHIBITION

Do not pour water onto the unit for cleaning

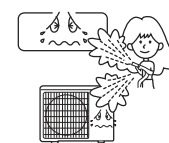

PROHIBITION

Do not place animals or plants in the direct path of the air flow

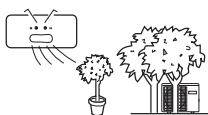

PROHIBITION

Do not place any objects on or climb on the unit.

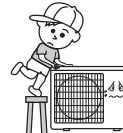

PROHIBITION

Do not place flower vase or water containers on the top of the unit.



PROHIBITION

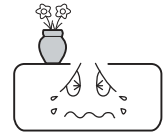

Trouble shooting

Phenomenon	Cause or check points
Poor cooling or poor heating	<p>Is the air filter dirty? normally it should be cleaned every 15 days.</p> <p>Are there any obstacles before inlet and outlet?</p> <p>Is temperature set correctly ?</p> <p>Are there some doors or windows left open?</p> <p>Is there any direct sunlight through the window during the cooling operation(use curtain)</p> <p>Are there too much heat sources or too many people in the room during cooling operation?</p> <p>IS the horizontal flap direction right?</p> <p>It should be kept horizontal or upward during cooling operation while set horizontal or downward during heating operation.</p>
Water leakage	The air filter is dirty .The unit is tilt installed.
A swishing or gurgling noise is heard	During unit operation or at stop, a swishing or gurgling noise may be heard .At first 2-3 minutes after unit start, this noise is more noticeable (This noise is generated by refrigerant flowing in the system.)
A cracking noise is heard	During unit operation, a cracking noise may be heard.This noise is generated by the casing expanding or shrinking because of temperature changes.
Smells are generated	The is because the system circulates smells from the interior air such as the smell of furniture, paint, cigarettes.
Mist or steam are blown out	During COOL or DRY operation, indoor unit may blow out mist. This is due to the sudden cooling of indoor air.
COOL mode changes to FAN mode automatically	To avoid frosting on the heat exchanger of the indoor unit, the air conditioner sometimes changes to FAN mode in COOL operation.but immediately it will change back to COOL mode.
The system does not restart immediately	When unit is stopped, it won't restart immediately unit 3 minutes have elapsed to protect the system. When the electric plug is pulled out and reinserted, the protection circuit will work for 3 minutes to protect the air conditioner.
In HEAT mode, the outdoor unit generates water or steam.	This is because the frost on the heat exchanger of the outdoor unit is melting (in COOL operation) .
the fan motor of indoor unit will continue running even though the HEAT operation is stopped.	For the sake of removing the remaining heat, the fan motor of indoor unit will continue running for some time after the heat operation's stop.
In DRY mode, fan speed can't be changed.	In DRY mode, when room temperature becomes lower than temp. setting +2°C unit will run intermittently at LOW speed regardless of FAN setting.
None of the units operates	Check the power supply: make sure the rated voltage is supplied. Check if the residual current circuit breaker trip?(make sure cut off the power supply off and contact the service station immediately.)
The temperature displayed on the control panel is different from the temperature detected by the user	In consideration of the temperature difference in the room, the air conditioner will automatically compensate the temperature In order to improve the comfortableness .therefore it is normal phenomenon.

Installation Precautions

Caution

This manual describes the use of Qingdao Haier Air-conditioner Limited Company set up the installation of tools for air conditioners to install the method.

1. In order to make the air conditioner work well, please install the air conditioner in accordance with the requirements of this manual.
2. When moving the air conditioner, be careful not to scratch the surface of the casing.
3. Please use the connecting pipe supplied by the company to connect the indoor and outdoor machines.
4. The maximum length of the connecting pipe is 20 meters, and the maximum height difference between the indoor machine and the outdoor machine is 10 meters.
5. To prevent turning over, please do not push, pull the indoor machine body..
6. After installation, please use the air conditioner correctly according to the instruction manual.
7. Please keep the manual for use in repair or replacement of the installation location.

Necessary Tools for Installation

- Driver
- Nipper
- Hacksaw
- Hole core drill
- Spanner(17,19 and 26mm)
- Gas leakage detector or soap-and-water solution
- Torque wrench (17mm,22mm,26mm)
- Pipe cutter
- Flaring tool
- Knife
- Measuring tape
- Reamer

Selection of Installation Place

Installation of indoor unit

Place where it is easy to route drainage pipe and outdoor piping.

Place away from heat source and with less direct sunlight.

Place where cool and warm air could be delivered evenly to every corner of the room.

Place near power supply socket. Leave enough space around the unit.

Place robust not causing vibration,where the body can be supported sufficiently.

Installation of outdoor unit

selection of installation place

Place strong enough to support the unit and will not cause vibration and noise.

Place where discharged wind and noise doesn't cause a nuisance to the neighbors.

Place where is less affected by rain or direct sunlight and is sufficiently ventilated,or to install a shield.

Place with enough space for smooth air flow.

Selection of pipe

Liquid pipe ϕ 6.35×0.53mm

Gas pipe ϕ 12.7×0.8mm

- To this unit, both liquid and gas pipes shall be insulated as they become low temperature in operation.
- Use optional parts for piping set or pipes covered with equivalent insulation material.

Power Source

Before inserting power into receptacle, check the voltage without fail.

The power supply is the same as the corresponding nameplate. Install an exclusive branch circuit of the power. A receptacle shall be set up in distance where the power cable can be reached. Do not extend the cable by cutting it.

Accessory Parts

No.	Shape	QTY
1	Prevent fall parts	1
2	Dry battery	2
3	Drain Pipe	1
4	Bracket	4
5	Plain cushion	3
6	Screw set / nuts	1
7	Wall hole cover	1
8	Remote controller	1
9	User manual	1

Drawing for the Installation of Indoor and outdoor Unit

The models adopt HFC free refrigerant R32

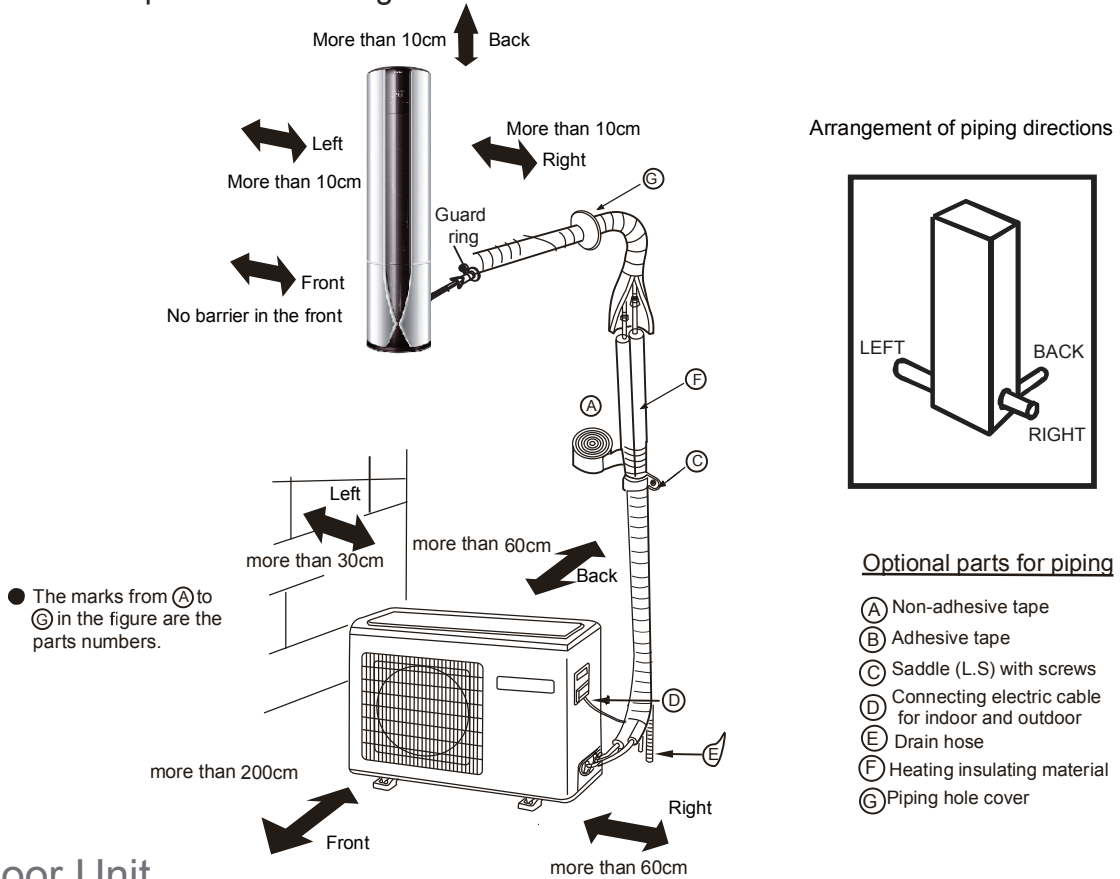

Indoor Unit

1. Installation of the indoor machine

● Making a Hole on the Wall and Fitting the Piping Hole Cover

- Position of the wall hole

Wall hole should be decided according to installation place and piping direction (refer to installation drawing on the left).

- Making a wall hole

Make a wall hole with a little slope towards outside. Install the guard ring and seal it with plaster.

- Fixed the indoor machine

The top of the machine is fastened to the wall with a metal bracket.

The whole machine is placed horizontally, and the inclination is less than 1°.

● Installation of metal bracket

There is no gap between the metal bracket and the machine and is fastened with screws (Fig. 1). After the machine is placed horizontally, the metal bracket is connected to the wall by screws (Fig. 2).

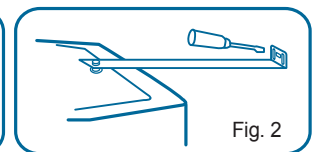
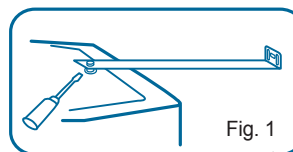
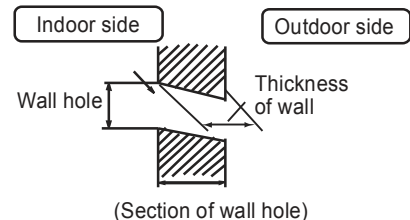

2. Piping connection of the indoor unit

● Arrangement of piping and drainage pipe

1. Remove the left & right down decorative board by removing the settled screw and pulling them forward.

2. Remove the back decorative board by removing the two screws on the top of the middle.

3. Remove the front decorative board by removing the settled four screws.

4. Remove the cover of the electrical box by removing all the screws of the electrical box and lifting them up. Then you will see the electrical box as shown in the picture.

● Cut away, with a hammer or a saw, the lid for piping according to piping direction



According to the piping method, connect the piping on indoor unit with union of connection pipe, arrange the piping according to the position of the wall hole and bind drain hose, connecting electric cable and piping together with polyethylene tape. Insert the bound piping, connecting electric cable and drain hose through wall hole to connect with outdoor unit.

● Arrangement drain hose

Drain hose shall be placed in under place.

There should be a slope when arrange drain hose. Avoid up and down waves in drain hose.

If humidity is high, drain pipe (especially in room and indoor unit) must be covered with installation material.

- **Arrangement of the drain hose**
Drain hose shall be placed in under place.
There should be a slope when arrange drain hose. Avoid up and down waves in drain hose. If humidity is high, drain pipe(especially in room and indor unit) must be covered with installation material.

Diameter of Copper tube(mm)	Tightening torque(N.m)
Φ 6	18 - 20
Φ 9	30 - 35
Φ 12	50 - 55
Φ 15.88	60 - 65

- **Installation of connecting pipe**
First connect the indoor unit, then connect the outdoor unit.
Connect the low pressure pipe first and then the high pressure pipe. The nut should not be tightened too tightly to prevent leakage.

Outdoor unit

Connecting the indoor/outdoor Electric Cable

- **Removing the wiring cover**
Remove terminal cover at the electrical box of indoor unit ,then take off wiring cover by removing its screws.
- **When connecting the cable after installing the indoor unit**
 1. Insert from outside the room cable into left side of the wall hole in which the pipe has already existed.
 2. Pull out the cable on the front side, and connect the cable making a loop.
- **When connecting the cable before installing the indoor unit**
Insert the cable from the back side of the unit, then pull it out on the front side.
Loosen the screws and insert the cable ends fully into terminal block,then tighten the screws.
Pull the cable slightly to make sure the cables have been properly inserted and tightened.
After the cable connection, never fail to fasten the connected cable with the wiring cover.
Note: When connecting the cable, confirm the terminal number of indoor and outdoor units carefully.
If wiring is not correct,proper operation can not be carried out and will cause defect.
The cable should be installed by the experienced technicians .
 1. If the supply cord is damaged, it must be replaced by the manufacturer or its service agent or a similar qualified person.
 2. If the fuse of indoor unit on PC board is broken,please change it with the type of T. 3.15A/ 250V ;
If the fuse of outdoor unit is broken,change it with the type of T.25A/250V
 3. The wiring method should be in line with the local wiring standard.
 4. A breaker should be incorporated with into wiring.The breaker should be all-pole switch and the distance between its two contacts should be not less than 3mm.
 - 5.

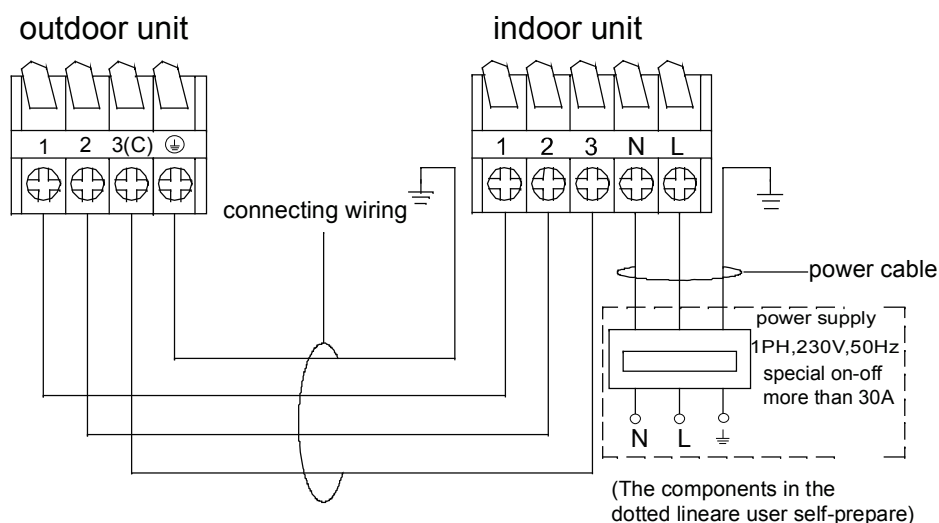

connecting wiring:
YZW, no less than 4*2.5mm²

power cable:
VDE, no less than 3*4.0mm²

Outdoor unit

1 Installation of Outdoor Unit

Install according to **Drawing for the installation of indoor and outdoor units**

- **Fixed the unit**
First, the metal mounting bracket is fixed on the wall, the expansion bolts of the fixed bracket should be in the same size, the quantity ≥ 6 pcs and the diameter ≥ 12 mm. Then put the outdoor machine flat and fixed on the stand.
- **Installation of drainage elbow**
If you use a drainage elbow, refer to the following image to install. Where the temperature is very low ($\leq 0^{\circ}\text{C}$) is not recommended to use the drainage elbow.

Hint:

1. Single cooler does not require this installation
2. Drain elbow and drain pipe contact for sale after purchase
3. Handle drainage problems when installing the outdoor unit

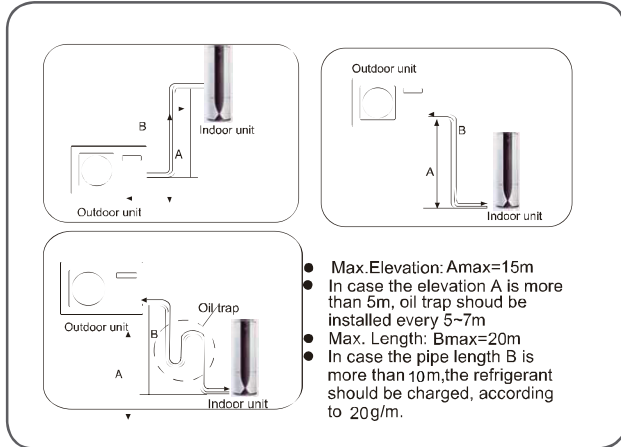

2 Connection of pipes

Inject refrigerant according to the right	Length of the pipe	Refrigerant addition
	10	/
	15	200
	20	300

- When the pipe is lengthened, the after-sales installer should be equipped with a professional evacuation pump to evacuate the air inside the pipe..
- The R32 refrigerant injected into the new factory air conditioner is the net gas injection amount. It is forbidden to use the internal row method for emptying.
- To bend a pipe, give the roundness as large as possible not to crush the pipe, and the bending radius should be 30 to 40mm or longer.
- Connecting the pipe of gas side first makes working easier.
- The connection pipe is specialized for R32.

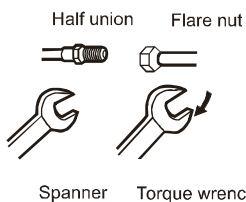

Forced fastening without careful centering may damage the threads and cause a leakage of gas.

Pipe Diameter(ϕ)	Fastening torque
Liquid side 6.35mm(1/4")	18N.m
Liquid/Gas side 9.52mm(3/8")	42 N.m
Gas side 12.7mm(1/2")	55N.m
Gas side 15.88mm(5/8")	60 N.m

Be careful that matters, such as wastes of sands, etc. shall not enter the pipe.

3 Connection

- Loosen the screws on terminal block and insert the plugs fully into terminal block, then tighten the screws.
- Insert the cable according to terminal number in the same manner as the indoor unit.
- If wiring is not correct, proper operation can not be carried out and controller may be damaged.
- Fix the cable with a clamp.

4 Attaching Drain-Elbow

- If the drain-elbow is used please attach the heat pump as figure



5 Purging Method: To use vacuum pump

1. Detach the service port's cap of 3-way valve, the valve rod's cap for 2-way valve and 3-way's, connect the service port into the projection of charge hose (low) for gaugemanifold. Then connect the projection of charge hose (center) for gaugemanifold into vacuum pump.
2. Open the handle at low in gaugemanifold, operate vacuum pump. If the scale-moves of gauge (low) reach vacuum condition in a moment, check 1. again.
3. Vacuumize for over 15min. And check the level gauge which should read -0.1MPa (76 cm Hg) at low pressure side. After the completion of vacuumizing, close the handle 'Lo' in gaugemanifold and stop the operation of the vacuum pump. Check the scale and hold it for 1-2min. If the scale-moves back in spite of tightening, make flaring work again, the return to the beginning of 3.
4. Open the valve rod for the 2-way valve to an angle of anticlockwise 90 degrees. After 6 seconds, close the 2-way valve and make the inspection of gas leakage.

5. No gas leakage?

In case of gas leakage, tighten parts of pipe connection. If leakage stops, then proceed 6. steps

If it does not stop gas leakage, discharge whole refrigerants from the service port. After flaring work again and vacuumize, fill up prescribed refrigerant from the gas cylinder.

6. Detach the charge hose from the service port, open 2-way valve and 3-way. Turn the valve rod anticlockwise until hitting lightly.
7. To prevent the gas leakage, turn the service port's cap, the valve rod's cap for 2-way valve and 3-way's a little more than the point where the torque increases suddenly.
8. After attaching the each caps, check the gas leakage around the caps.

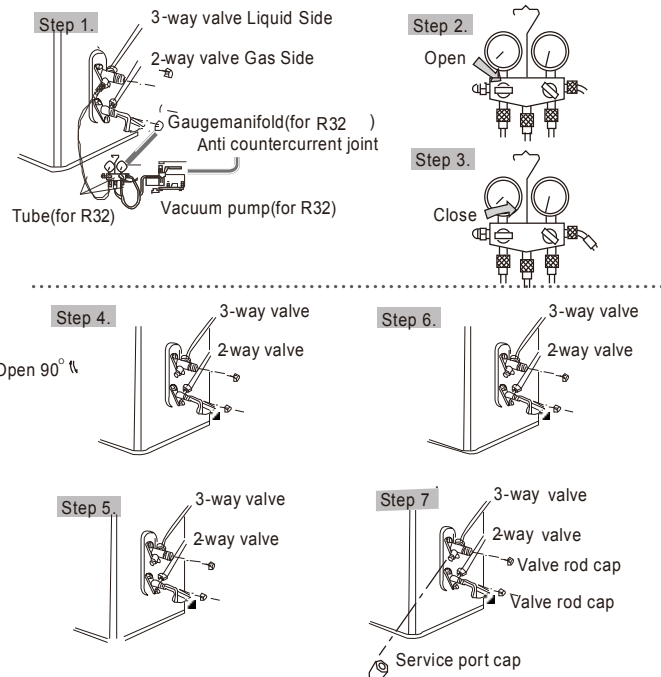

⚠ Caution

- If the refrigerant of the air conditioner leaks, it is necessary to discharge all the refrigerant. Vacuumize first, then charge the liquid refrigerant into air conditioner according to the amount marked on the name plate.
- Please do not let other cooling medium, except specified one (R32), or air enter into the cooling circulation system. Otherwise, there will be abnormal high pressure in the system to make it crack and lead to personal injuries.

1 Power Source Installation

- The power source must be exclusively used for air conditioner. (Over 10A)
- In the case of installing an air conditioner in a moist place, please install an earth leakage breaker.
- For installation in other places, use a circuit breaker as far as possible.

2 Cutting and Flaring Work of Piping

- Pipe cutting is carried out with a pipe cutter and burs must be removed.
- After inserting the flare nut, flaring work is carried out.

	Flare tool for R32	Conventional flare tool	
	Clutch-type	clutch-type(Rigid-type)	Wing-nut type (Imperial-type)
A	0~0.5mm	1.0~1.5mm	1.5~2.0mm

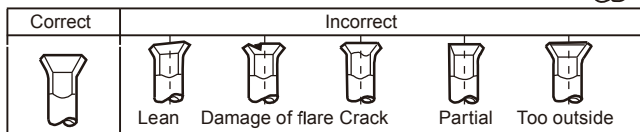
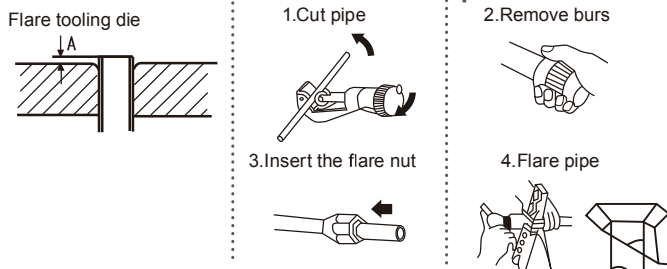

■ Check for Installation and Test Run

- Please kindly explain to our customers how to operate through the instruction manual.

Check Items for Test Run

— Put check mark ✓ in boxes

- Gas leak from pipe connecting?
- Heat insulation of pipe connecting?
- Are the connecting wirings of indoor and outdoor firmly inserted to the terminal block?
- Is the connecting wiring of indoor and outdoor firmly fixed?
- Is drainage securely carried out?
- Is the earth line securely connected?
- Is the indoor unit securely fixed?
- Is power source voltage abided by the code?
- Is there any noise?
- Is the lamp normally lighting?
- Are cooling and heating (when in heat pump) performed normally?
- Is the operation of room temperature regulator normal?
- Power Supply: L should be connected to the fire line
- N should be connected to the zero line
- ⊕ should be connected to the ground wire

⚠ Caution

The fire wire, zero line and grounding wire must be connected as required, location can not be wrong and reliable connection, and no internal short circuit. If the connection is wrong, it may cause a fire.

Maintenance

Cleaning of the unit

⚠ Caution

In the air conditioner outdoor heat exchanger, if dirty plugging occurred, this could lead to the cooling/heating efficiency of air-conditioners reduced, and even damaged the compressor. So if the outdoor heat exchanger is dirty, please contact the after-sales for professional cleaning.

- Turn off the power switch.
- Do not touch with wet hand.
- Do not clean with hot water or solvent.
- Do not use hot water (temp. higher than 40°C), which may cause discoloration or distortion.
- Do not use pesticides or other chemical detergents.

Clean the filter

Use water or vacuum cleaner to remove dust. If it is too dirty, clean with detergent or neutral soap water. Rinsing with fresh water, dry the filter and reassemble.

⚠ Caution

Do not wash filter in hot water above 40°C, Which will damage the filter. Do carefully wipe the filter.

Clean the indoor(outdoor)unit

Clean with warm cloth or neutral detergent, Then wipe away moisture with dry cloth. Do not use too hot water(above 40°C), Which will cause discoloration or deformation. Do not use pesticide or other chemical Detergents.

The machine is adaptive in following situation

Applicable ambient temperature range:

Cooling	Indoor	Maximum:D.B/W.B 32°C/23°C Minimum:D.B/W.B 18°C/14°C
	Outdoor	Maximum:D.B/W.B 43°C/26°C Minimum: D.B 18°C
Heating	Indoor	Maximum:D.B 27°C Minimum D.B 15°C
	Outdoor	Maximum:D.B/W.B 24°C/18°C Minimum:D.B -15°C

Hint:

When used in the above conditions, the cooling effect will be reduced when close to the maximum temperature of the refrigeration (sunlight can be avoided by shading measures). The heating effect decreases when close to the minimum temperature of the heating system.

Maintenance

Seasonal Storage

- Maintenance after use of the season
 - On sunny days, when the air conditioner is in standby state, press the wind/purge button, the machine would go into the wind mode. Start-up operation about half a day, so that the inside of the air conditioner could be completely dry.
 - Turn off the switch of the air conditioner and turn off the power. Otherwise, even if the air conditioner is in a stopped state, it still will consume certain power.
 - Cleaning both the indoor and outdoor machines. If the condition permits, the machine could be covered with a housing.
- Maintenance before use of the season Check the inlet and outlet of indoor and outdoor machines for obstructions, so as to avoid reducing work efficiency.



Haier

Address: No.1 Haier Road, Hi-tech Zone, Qingdao 266101 P.R.China

Contacts: TEL +86-532-8893-6943; FAX +86-532-8893-1010

Website: www.haier.com