

Haier
HVAC Solutions

Professional, Smart &
Healthy Air Solutions

Commercial & Applied HVAC Solutions

Catalogue 2023/24





This warranty includes parts only.
For further details and requirement,
please contact your Haier partner



CONTENTS

01	RANGE	15
02	MRV S II	21
	Outdoor Units - Front Air Discharge	
03	MRV 5-H	31
	Full DC Inverter Outdoor Units	
04	MRV 5-RC	53
	3-Pipe Heat Recovery Outdoor Units	
05	MRV-W	69
	Water Cooled Heat Pump Outdoor units	
06	MRV INDOOR UNITS	81
	Smart Flow All-Way Cassette	82
	4-Way Standard Cassette compact	84
	Wall Mounted Units	85
	1-Way Cassette	90
	2-Way Cassette	91
	Ceiling / Floor Convertible	92
	Slim Duct - Low Pressure	95
	Ducted - Medium Pressure	96
	Ducted - High Pressure	97
	Ducted - Fixed flow	98
	Floor Console - Built-in	99
	Floor Console, Exposed type, Double Flow	100
	Fresh Air Duct	101
	Hydrobox	104
	Unit Dimensions	106
07	EASY MRV	117
	Supermatch Indoor Unit	
08	MRV AHU Application	128
09	Control, Management systems & Accessories	135

Haier Brand Story

Established in 1984, Haier Group is a world-leading provider of solutions to better life. In the process of sustainable innovation and entrepreneurship, Haier always upholds the principle of "prioritising people's value". Mr. Zhang Ruimin, Ex-Chairman of the Board and CEO of Haier Group, first proposed the Rendanheyi Model in September 2005. After 15 years of development and innovation, Rendanheyi has achieved trans-culture, trans-industry and replication with its contemporary features.

Focusing on user experience, Haier has grown from the once collectively owned small factory into an ecosystem that leads the IoT era. As the world's first and only IoT ecosystem brand, Haier has been included on the list of BrandZ™ Top 100 Most Valuable Global Brands for four consecutive years. Haier has topped Global Major Appliances Brand Rankings by Euromonitor International for 13 consecutive years. It's subsidiary Haier Smart Home is among the list of Global Fortune 500.

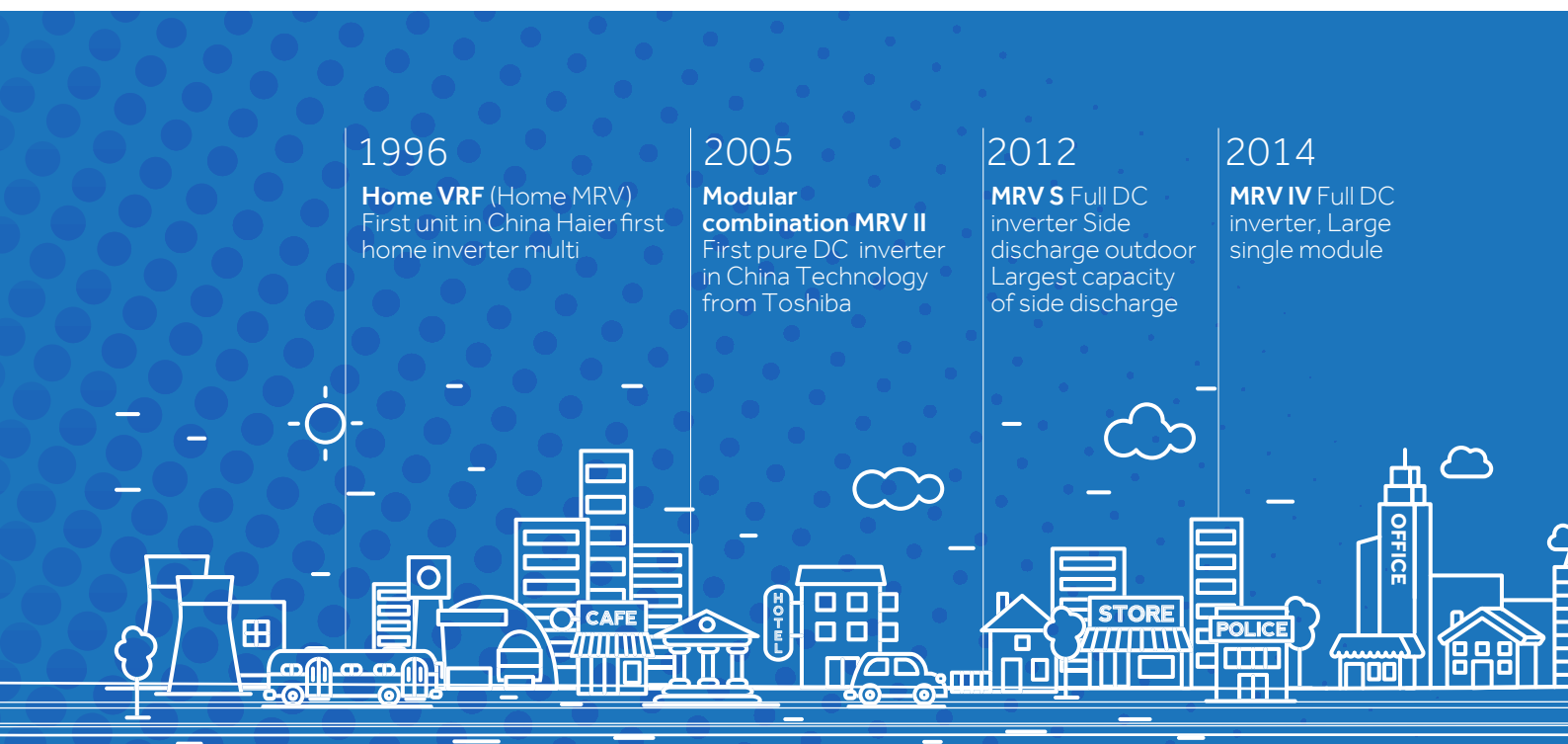

1996

Home VRF (Home MRV)
First unit in China Haier first home inverter multi

2005

Modular combination MRV II
First pure DC inverter in China Technology from Toshiba

2012

MRV S Full DC inverter Side discharge outdoor
Largest capacity of side discharge

2014

MRV IV Full DC inverter, Large single module

1993

Haier Enter into China commercial AC field

1999

Commercial VRF (C-MRV) First Modular VRF unit in China

2008

MRV III DC Inverter
23 Olympic reference projects in Beijing

2013

MRV III-RC Heat recovery (3 pipe system)

MRV W
Water-cooled / MRV

To date, Haier Group owns four listed companies, has six platforms including Haier Smart Home, COSMOPlat, Ririshun, Yingkang Life, Haier Biomedical, Haina Cloud and HCH, and has Seven global brands such as Haier, Casarte, Leader, GE Appliances, Fisher & Paykel, AQUA, Candy and Hoover. It has successfully incubated 5 unicorn companies and 23 gazelle companies. Moreover, Haier has established 10+N open innovation systems, 29 industrial parks, 122 manufacturing centers, 108 marketing centers and more than 140,000 sales networks around the globe, it has gone deep into 200+ countries and regions globally, serving more than 1 billion user families.

Upholding the vision of "creating new engines to growth in the era of IoT with the Rendanheyi Model", Haier Group is committed to working with its world-class ecosystem partners to continuously build premium brands and to set up IoT ecosystems in all industries including Health, Retail, Leisure, Travel and Education and to tailor personalized smart life for users around the globe.

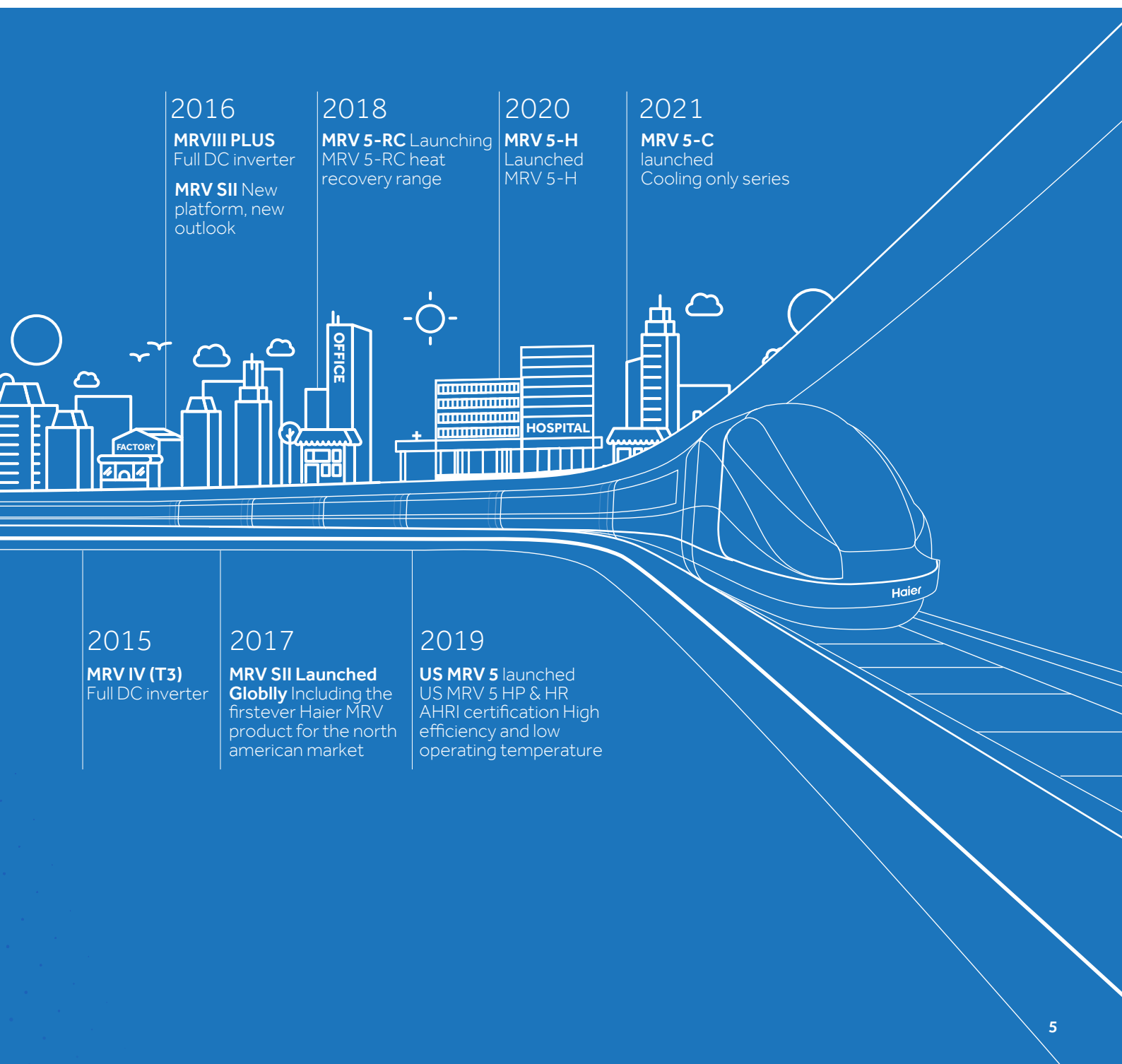

2016

MRVIII PLUS
Full DC inverter
MRV SII New platform, new outlook

2018

MRV 5-RC Launching
MRV 5-RC heat recovery range

2020

MRV 5-H
Launched
MRV 5-H

2021

MRV 5-C
launched
Cooling only series

2015

MRV IV (T3)
Full DC inverter

2017

MRV SII Launched Globally Including the firstever Haier MRV product for the north american market

2019

US MRV 5 launched
US MRV 5 HP & HR
AHRI certification High efficiency and low operating temperature

Haier Global Network

Haier has built its infrastructure in various parts of the world to quickly meet the demands of its customers including R&D centres, production facilities, commercial companies and sales points.

Through the 10 R&D centres around the world, Haier has forged strategic alliances with first-class providers, research institutes and prestigious universities to create an innovative ecosystem of scholars and engineers connected by a single virtual and physical network.



Candy Turkey Factory



Candy Italy Factory



Haier Refrigerator Factory in Romania



GE Appliance Park, Louisville, U.S.



Haier Nigeria Factory



Haier AC Factory in Egypt

-  **10+N**
R&D Centers
-  **108**
Marketing Centers
-  **29**
Industrial Parks
-  **122**
Factories
-  **200+**
Countries or Regions



The world's only ecosystem brand for four consecutive years.



Haier has ranked No.1 Global Major Appliance Brand for 13 consecutive years.
Source from Euromonitor.



Haier Smart Home was named one of Fortune's most admired companies in the world.



In 2021, Haier Smart Home was once again listed on the Fortune Global 500.



Haier Global Manufacturing Capacity

Haier AC has 8 production facilities in China, another 8 located between South Asia and North Africa. These factories have a total production capacity of over 27.2 million units per year.



Eurovent

Haier has been awarded the prestigious Eurovent certification for its MRV outdoor units, and the entire production facility. This recognition further underlines Haier's desire to create high-quality, high-performance and environmentally friendly products and services.



CERTIFICATE
N° 20.12.030



Eurovent Heat Pumps / Pompes à chaleur Eurovent

Range Name / Nom de Gamme :
MRV 5-H

Granted on December 17, 2020 - Date 1ère admission 17 décembre 2020

This document is valid at the date of issue - Check the current validity on:
Document valable à la date d'émission - Vérifier la validité en cours sur :
www.eurovent-certification.com

Participant/Titulaire

Haier Overseas Electric Appliances Corp. Ltd
South room #401, Brand Center Building - Haier High-Tech Industrial Park, Lao Shan District,
266101 Qingdao (Shandong Province), China

This product performance certificate is issued by Eurovent Certita Certification according to the certification rules:

ECP Eurovent-HP - « Eurovent Heat Pumps » in force at established date.

Pursuant to the decision notified by Eurovent Certita Certification, the right to use the mark ECP shall be granted to the beneficiary company for the above Range in the conditions defined by the certification program mentioned.

Unless withdrawn or suspended, this certificate remains valid as long as the requirements for the certification program framework are met. The validity of the certificate is to be verified on www.eurovent-certification.com

THIS CERTIFICATE HAS BEEN ISSUED ON 06/01/2023
THIS CERTIFICATE IS VALID UNTIL 31/12/2023

Ce certificat de performance produit est délivré par Eurovent Certita Certification dans les conditions fixées par le référentiel :

ECP Eurovent-HP – « Pompes à chaleur Eurovent » en vigueur à date d'édition.

En vertu de la décision notifiée par Eurovent Certita Certification, le droit d'usage de la marque ECP, est accordé à la société qui en est bénéficiaire pour la gamme visée ci-dessus, dans les conditions définies par le programme de certification mentionné.

Sauf retrait ou suspension, ce certificat demeure valide tant que les conditions du référentiel du programme de certification sont respectées. La validité du certificat est à vérifier sur le site Internet www.eurovent-certification.com

CE CERTIFICAT A ÉTÉ EMIS LE 06/01/2023
CE CERTIFICAT EST VALIDE JUSQU'AU 31/12/2023

Paris, 6 janvier 2023



Organisme accrédité n° 5-0517 Certification Produits et Services selon la norme NF EN ISO/CEI 17065:2012
Portée disponible sur www.cofrac.fr

Accreditation #5-0517 Products and Services Certification according to NF EN ISO/CEI 17065:2012 – Scope available on www.cofrac.fr

COFRAC est signataire des accords MLA d'EA et MLA d'IAF.

COFRAC is signatory of EA MLA and IAF MLA,

list of EA members is available on

www.european-accreditation.org/ea-members

list of IAF members is available on

www.iaf.nu/articles/IAF_MEMBERS_SIGNATORIES/4

MANAGING BOARD MEMBER / MEMBRE DIRECTOIRE

EUROVENT CERTITA CERTIFICATION SAS au capital de 100 000 € - 48-50 rue de la Victoire 75009 Paris - FRANCE
Tel. : 33 (0)1 75 44 71 71 - 513 133 637 RCS Paris - SIRET 513 133 637 000 35 - TVA FR 59513133637

S06D06 TEMPLATE_ECP_RANGE_REV1.1

Haier AC R&D CENTER



R&D Labs



Evaluation of comfort



Rain simulation



Performance testing



Safety testing



Noise testing



Electromagnetic compatibility testing



Snow simulation



Sun simulation



Reliability testing



Humidity control test



Double 85 test



Drop test

Haier has set a new standard for HVAC laboratories, giving life to what today represents 'The state of the art' and one of its kind. Operating since March 2014, it is now the world's reference point.

Inside the "Haier Park" industrial complex in Qingdao China, there is the world's most advanced laboratory for testing, research and development of products for the HVAC (heating, ventilation, cooling) sector. The 'Haier Park' has a large exhibition space with the most significant Haier innovations. You can also view the powerful Haier centrifugal chiller with magnetic suspension compressor used for comfort cooling in large commercial buildings.

Developed on 10 floors, each with different themes, you can learn about over 1,000 different technological experiences. The building has an impressive 150 laboratories where it is possible to test all products according to all national and international regulations specific to the HVAC sector. From calorimeters, to anechoic halls, to atmospheric simulators, electromagnetic tests and more.

Haier employs specialised engineers from all over the world and initiate several collaborations with many renowned manufacturers worldwide. The 'Haier Tower' is a proud landmark for Haier. It is located next to the main set of laboratories at the 'Haier Park'. With a height of 106 m, the highest in the world, the 'Haier Tower' encompasses 5 laboratories where our MRV systems and beyond are tested, predicting and controlling all the variables that can occur in the phases of installation and real operation. With the creation of this futuristic laboratory, Haier wanted to reaffirm its intention to becoming a world-leading manufacturer in the HVAC sector.

Global Certifications



Haier AC IN EUROPE

Haier is a global leading provider of smart and comfort solutions with an ambition to continuously deliver unique and advance technologies, superior design and tailor-made experiences when it comes to the environment you're in and the air you breath. We have truly increased our presence in Europe as a trustworthy brand with a premium product offering, a growing network of distributors, post-sale service and 6-year warranty.

Haier Group was established in 1984 in Qingdao by Zhang Ruimin who has centred the business around the RenDanHeYi philosophy. The well-respected model, developed and implemented by Mr. Ruimin, is revolutionary as no other company operates in this way. RenDanHeYi puts the needs of the user first, with the model's core component being "zero distance" to the customers. At Haier are empowered to provide outstanding commitment and value to our partners and end customers, keeping them at the forefront at all times.

We have since gone from strength to strength, by continuously striving for the best in class and working towards developing premium products for Global markets with IoT at the heart of our R&D and product development. We have been on the list of BrandZ Top 100 Most Valuable Global Brands

for four consecutive years as the world's first and only IoT ecosystem brand. Haier has also topped Global Major Appliances Brand Rankings by Euromonitor International for 13 consecutive years.

Haier's European HVAC operations has been active for over 30 years where we are fully supported by some of the most talented and dedicated partners and teams across Europe including, Italy, Spain, Portugal, UK, France, Central Europe and Germany. These markets carry a wide range of products which includes, Residential & Light Commercial solutions as well as Large Commercial and Heating Solutions, giving us a truly diverse offering to suit various applications from residential to larger Hotels and Retail applications.

Our total production capacity is over 27 million sets per year, supported by 16 Air Conditioning factories with 8 of them being in overseas markets. This outstanding capacity enables us to continually strive to lead the market in delivering Smart and Healthy solutions across Europe.



HVAC EUROPEAN TRAINING HUB

In 2022 we celebrated the opening of our new bespoke European training centre in Barcelona which is fully dedicated to HVAC. The new training Hub can facilitate a range of training programmes which is tailored to the needs of our installers and consultants.

All fully operational the Training Hub has an installation of many of our key products from across the portfolio, including a range of indoor and outdoor units, controls and a dedicated room for heating solutions. In fact, the building itself is a case study with an installation of an MRV5-H with continuous heating connected to a number of indoors units as well as a water heater.

We look forward to welcoming our Distributors, Installers and Designers to come and experience Haier's HVAC Solutions first-hand.





MRV





Meet the range



RANGE

MRV S II Outdoor Units

SERIES	4-5 HP	4 HP	5 HP	6 HP	8 HP	10 HP	12 HP
Model	AU042FNPERA AU052FNPERA	AU042FPERA AU041FPERA	AU052FPERA AU051FPERA	AU062FPERA AU061FPERA	AU08NFKERA	AU10NFKERA	AU12NFKERA
MRV S II							

MRV 5 - H Full DC Inverter 2-pipe Heat Pump

SERIES	8 HP	10 HP	12 HP	14 HP	16 HP	18 HP	20 HP	22 HP	24 HP	26 HP	28 HP	30 HP	32 HP	34 HP
MRV 5 - H Model	AV08	AV10	AV12	AV14	AV16	AV18	AV20	AV22	AV24	AV26	AV28	AV30	AV32	AV34NMVETA
	NMVETA					NMVETA					NMVETA			
														

SERIES	36 HP	38 HP	40 HP	42 HP	44 HP	46 HP	48 HP	50 HP	52 HP	54 HP	56 HP	58 HP	60 HP	62 HP	64 HP	66 HP	68 HP	70 HP	72 HP	74 HP	76 HP	78 HP
MRV 5 - H Model	AV36	AV38	AV40	AV42	AV44	AV46	AV48	AV50	AV52	AV54	AV56	AV58	AV60	AV62	AV64	AV66	AV68	AV70	AV72	AV74	AV76	AV78
	NMVETA											NMVETA										
																						

SERIES	80 HP	82 HP	84 HP	86 HP	88 HP	90 HP	92 HP	94 HP	96 HP	98 HP	100 HP	102 HP	104 HP
MRV 5 - H Model	AV80	AV82	AV84	AV86	AV88	AV90	AV92	AV94	AV96	AV98	AV100	AV102	AV104
	NMVETA												
													

RANGE

MRV 5 - RC Full DC Inverter 3-pipe Heat Pump

SERIES	8 HP	10 HP	12 HP	14 HP	16 HP	18 HP	20 HP	22 HP	24 HP	26 HP	28 HP	30 HP
Model	AV08	AV10	AV12	AV14	AV16	AV18	AV20	AV22	AV24	AV26	AV28	AV30IMVURA
	IMVURA			IMVURA			IMVURA					
MRV 5-RC												

SERIES	32 HP	34 HP	36 HP	38 HP	40 HP	42 HP	44 HP	46 HP	48 HP	50 HP	52 HP	54 HP	56 HP	58 HP	60 HP	62 HP	64 HP	66 HP
Model	AV32	AV34	AV36	AV38	AV40	AV42	AV44	AV46IMVURA	AV48	AV50	AV52	AV54	AV56	AV58	AV60	AV62	AV64	AV66
	IMVURA							IMVURA			IMVURA							
MRV 5-RC																		

SERIES	68 HP	70 HP	72 HP	74 HP	76 HP	78 HP	80 HP	82 HP	84 HP	86 HP	88 HP
Model	AV68	AV70	AV72	AV74	AV76	AV78	AV80	AV82	AV84	AV86	AV88
	IMVURA										
MRV 5-RC											

MRV 5 - RC 3-pipe connection kit

SERIES	$X \leq 11,2\text{KW}$	$11,2 < X \leq 18\text{KW}$	$18 < X \leq 28\text{KW}$	4 ways - max 11,2kW for single output.
Model	VP1-112C	VP1-180C	VP1-280C	VP4-450C
VP - Boxes				

MRV W Water Cooled Heat Pump Outdoor Units













SERIES	8 HP	10 HP	12 HP	16 HP	18 HP	20 HP	22 HP	24 HP	28 HP	30 HP	32 HP	34 HP	36 HP
Model	AV08	AV10	AV12	AV16	AV18	AV20	AV22	AV24	AV28	AV30	AV32	AV34	AV36
	IMWEWA			IMWEWA				IMWEWA					
MRV-W													

AHU Kit to create direct-expansion air treatment units

SERIES	$3,5 \leq X \leq 7\text{KW}$	$7 \leq X \leq 14\text{KW}$	$14 \leq X \leq 28\text{KW}$	$28 \leq X \leq 56\text{KW}$	$56 \leq X \leq 73\text{KW}$
Model	AH1-070B	AH1-140B	AH1-280B	AH1-560B	AH1-730B
AHU KIT					
MRV Compatibility	"S" series with front air discharge and "5" series				

RANGE

EASY MRV Residential and Commercial Supermatch Indoor Units – Connectable to MRV Systems with MS Valves

INDOOR UNIT		2,0 kW	2,5 kW	3,5 kW	5,0 kW	7,1 kW	10,5 kW	12,5 kW	14,0 kW	16,0 kW
 JADE	AS50S2SJ1FA-3		●							
	AS35S2SJ1FA-3			●						
	AS50S2SJ1FA-3				●					
 EXPERT WHITE + BLACK	AS20XCAHRA/ AS20XCAHRA-MB	●								
	AS25XCAHRA/ AS25XCAHRA-MB		●							
	AS35XCAHRA/ AS35XCAHRA-MB			●						
	AS50XCAHRA/ AS50S2SF1FA-MB3				●					
	AS71XCAHRA/ AS71S2SF1FA-MB3					●				
	AS20S2SF1FA-MW3/ AS20S2SF1FA-MB3	●								
 FLEXIS PLUS WHITE + BLACK	AS25S2SF1FA-MW3/ AS25S2SF1FA-MB3		●							
	AS35S2SF1FA-MW3/ AS35S2SF1FA-MB3			●						
	AS50S2SF1FA-MB3/ AS50S2SF1FA-MW3				●					
	AS71S2SF1FA-MB3/ AS71S2SF1FA-MW3					●				
	AS20PBAHRA	●								
 PEARL	AS25PBAHRA		●							
	AS35PBAHRA			●						
	AS50PDAHRA				●					
	AS68PDAHRA					●				
 CONSOLE	AF25S2SD1FA(D)		●							
	AF35S2SD1FA(D)			●						
	AF42S2SD1FA(D)				●					
 CASSETTE 620	AB25S2SC2FA(H)		●							
	AB35S2SC2FA(H)			●						
	AB50S2SC2FA(H)				●					
 CASSETTE ROUND FLOW	AB71S2SG1FA(H)					●				
	ABH105H1ERG(H)						●			
	ABH125K1ERG(H)							●		
	ABH140K1ERG(H)								●	
	ABH160K1ERG(H)									●
 CEILING FLOOR	AC35S2SG1FA(H)			●						
	AC50S2SG1FA(H)				●					
	AC71S2SG1FA(H)					●				
	AC105S2SH1FA(H)						●			
	AC125S2SK1FA(H)							●		
	AC140S2SK1FA(H)								●	
 SLIM DUCT LOW PRESSURE	AD35S2SS1FA(H)			●						
	AD50S2SS1FA(H)				●					
	AD71S2SS1FA(H)					●				
 DUCTED MEDIUM PRESSURE	AD35S2SM3FA(H)			●						
	AD50S2SM3FA(H)				●					
	AD71S2SM3FA(H)					●				
	AD105S2SM3FA(H)						●			
	AD125S2SM8FA(H)							●		
	AD140S2SM8FA(H)								●	
 DUCTED HIGH PRESSURE	AD160S2SM3FA(H)									●
	ADH125H1ERG							●		
	ADH140H1ERG								●	
 CABINET	ADH160H1ERG									●
	AP140S2SK1FA(H)								●	
	AP160S2SK1FA(H)									●

EASY MRV MS Valves for Residential and Commercial Units

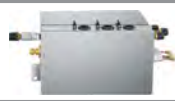
SERIES	11,2 kW	11,2 to 18,0 kW	Max 33,6 kW (max 11,2 kW per single output)
EASY MRV			
Model	MS1-036A	MS1-060A	MS3-036A
Combination with Number of IU	1:1	1:1	1:3
MRV Compatibility	"S" series with front air discharge and "5" series		

RANGE

MRV Indoor Units

SERIES	kBTU/h	5	7	9	12	16	18	24	28	30	38	48	60	72	96	106	
	kW	1,5	2,2	2,8	3,6	4,5	5,6	7,1	8,0	9,0	11,2	14,0	16,0	22,6	28,0	31,0	
CASSETTE SMART FLOW 4 WAY DC			•	•	•	•	•	•	•	•	•	•	•				
CASSETTE 4 WAY 60x60 DC		•	•	•	•	•	•										
FLOOR CONSOLE, BUILT-IN			•	•	•	•	•	•									
WALL (INTERNAL/EXTERNAL EEV)		•	•	•	•	•	•	•	•	•							
CASSETTE 1 WAY		•	•	•	•												
CASSETTE 2 WAY			•	•	•	•	•										
CEILING / FLOOR CONVERTIBLE				•	•	•	•	•	•	•	•	•					
SLIM DUCT LOW PRESSURE DC		•	•	•	•	•	•	•									
DUCTED MEDIUM PRESSURE		•	•	•	•	•	•	•	•	•	•	•	•				
DUCTED HIGH PRESSURE														•	•		
DUCTED - CONSTANT AIR FLOW			•	•	•	•	•	•		•							
CONSOLE		•	•	•	•	•	•										
DUCTED FRESH AIR ALL OUTDOOR AIR												•		•	•		
HYDROBOX NEW										•			•				•

SELECTION SOFTWARE

HAIER SELECTION SOFTWARE

EASY DESIGN AND CUSTOMISATION

The Haier Selection Software supports PC & Apps, which means the reports and information on all devices and phones are synchronised.

With the Haier MRV Selection software, engineers and consultants can easily design layouts and prepare a full MRV system in a few steps. It selects the right models to meet your building load requirements and calculates the piping schematic automatically or manually, as well as the wiring. It's possible to import DWG and JPG drawings. The selection software guides you within design rules and offers a comprehensive system design report in PDF, Word or Excel format.

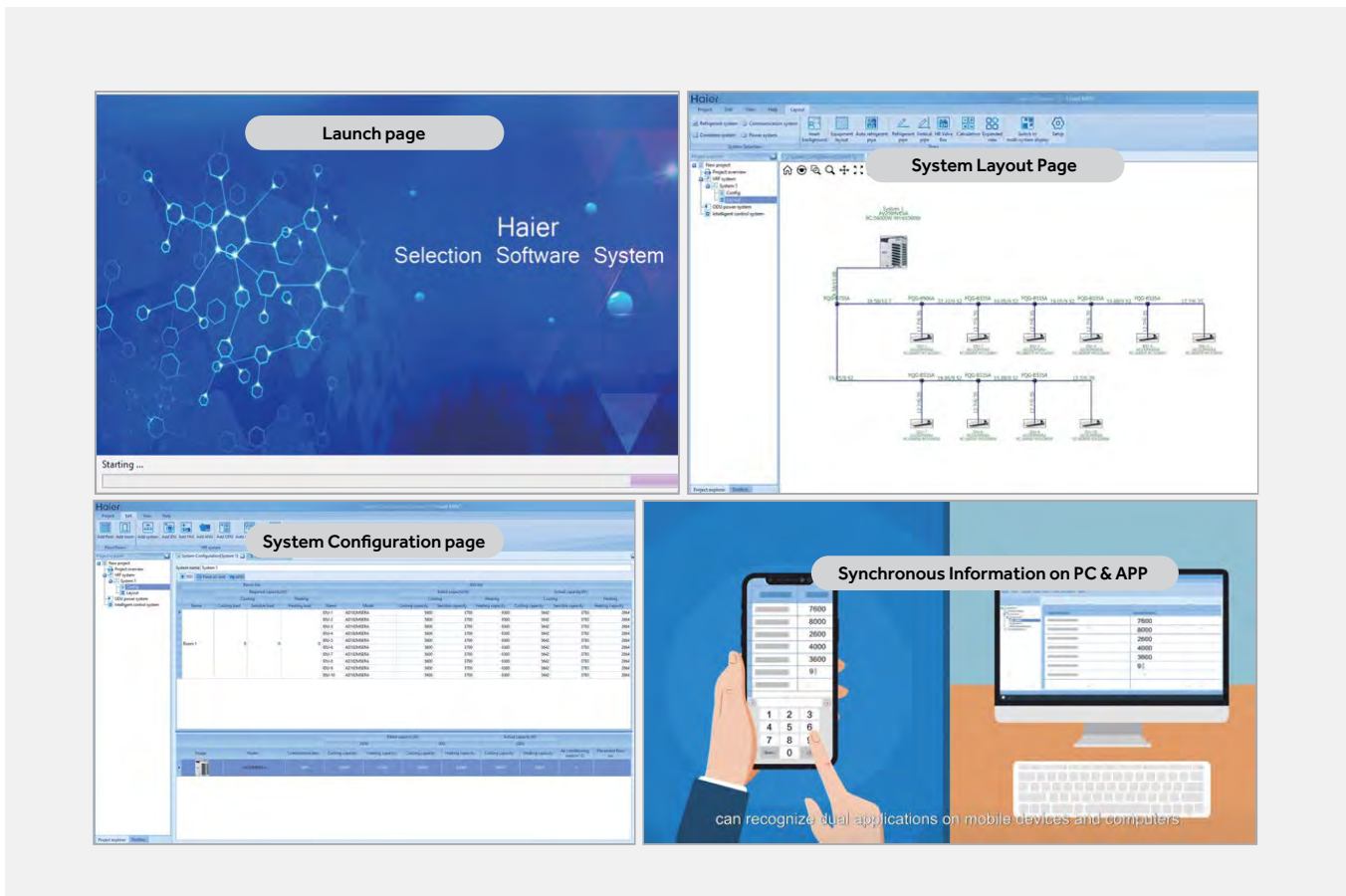

SERVICE TOOL TD-03 WITH MONITORING SOFTWARE

Installers can use TD-03 service tool together with monitoring software for real-time monitoring of the system as well as access to operating data of VRF system through the PC. The running data and parameters can be used to analyse error's for fast troubleshooting. You can save the data for further analysis.

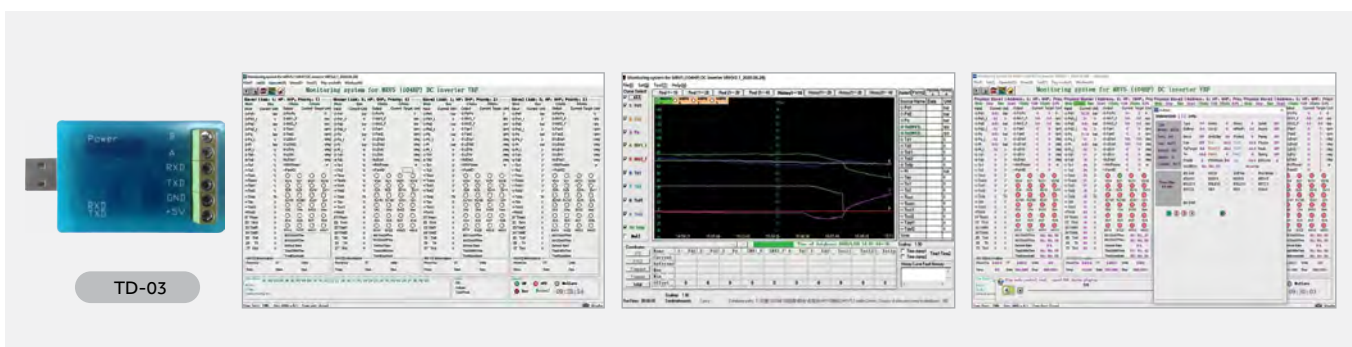

MRVS^{II}

DC Inverter Unit with Front Discharge

MRV S II - FEATURES

IMPROVED CONFIGURATION AND PERFORMANCE (8/10/12HP SIDE DISCHARGE)

Flexible applications with bigger outdoor capacity options.

High efficiency DC fan motor

- DC fan motor with stepless inverter control, increases efficiency by 45% comparing with AC motor.

Larger fan diameter

- Ø570mm larger axial flow fan
- Zigzag design, reduces disturbance in airflow as well as increasing air volume and reducing noise level.

High efficiency condenser

- Newly designed high efficiency inner grooved tube.
- New hydrophilic corrugated fissurefin increases efficiency.



Vector inverter control

- 180 degrees sine wave vector control, 64-bit operation
- Precision control achieves high efficiency and lower noise levels

Double pressure sensor

- Equipped with high and low voltage pressure sensors
- Accurate pressure control ensures the system runs smoothly, increasing energy efficiency.

Twin rotary DC Inverter compressor

- High chamber DC inverter twin rotary compressor
- Increased energy efficiency by achieving smaller vibrations and benefiting from lower sound levels.

LEADING TECHNOLOGY (4-6HP)

Two-stage super cooling cycle technology, increases efficiency by 9%. (Double fan) 30°C maximum temperature in cooling increases unit refrigerating capacity by 46%

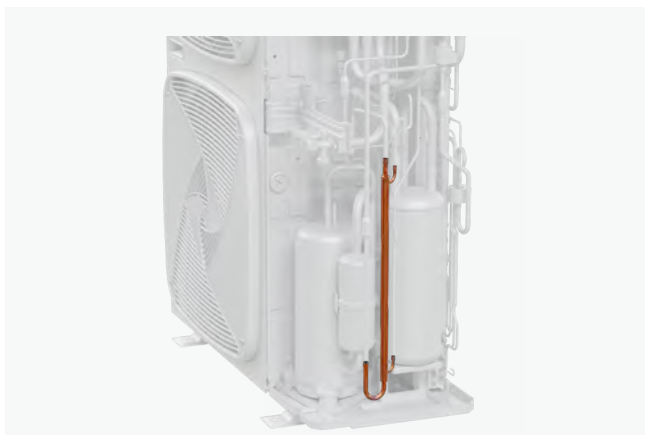

INCREASING POWERFUL HEATING CAPACITY

When the ambient temperature is low, the heat exchange capability of the outdoor unit is decreased and the amount of air returned by the compressor is reduced. By increasing the refrigerant flow during the heating cycle of the indoor unit heat exchanger, we improve the heating capacity.

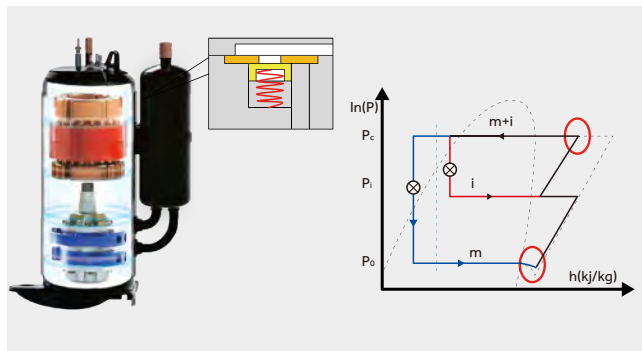

MRV S II - FEATURES

HIGH EER AND COP(8/10/12HP)

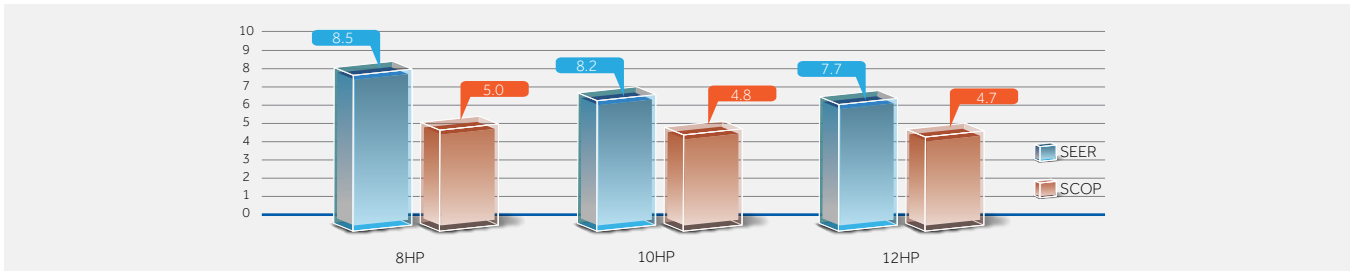

DC FAN AND FAN MOTOR

- DC inverter fan motor is highly efficient during part load operation
- 16-stage speed control; high efficiency operation especially in low speed

- 45% increase in efficiency compared with AC motor due to reduced input power
- 570mm diameter fan, increases air flow and achieves higher efficiency(8/10/12HP)

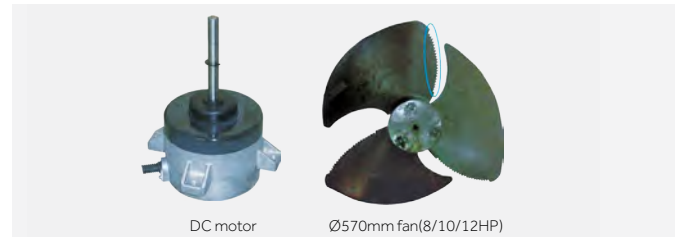
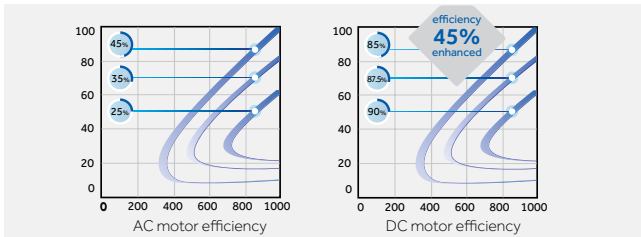

SELF-CLEANING FUNCTION ON INDOOR AND OUTDOOR UNITS

During operation, dirt accumulates on the evaporator. If the evaporator is not cleaned regularly, accumulated dirt reduces the thermal exchange by 15-30% and also promotes the proliferation of bacteria and mould.

The new Self Clean technology is the first of its kind to integrate the self-cleaning function of both the evaporator and the condenser. It starts with cleaning the evaporator, then switches to cleaning the condenser without stopping the compressor.

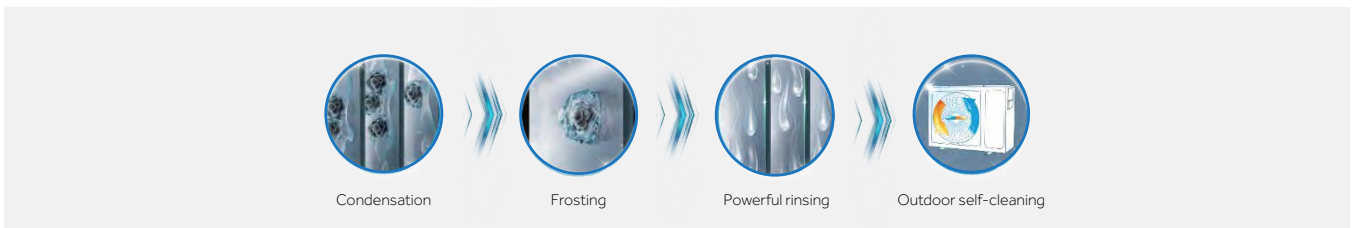

LOW NOISE LEVEL

- Night quiet operation function
- Noise levels can be reduced down to 45dB(A)

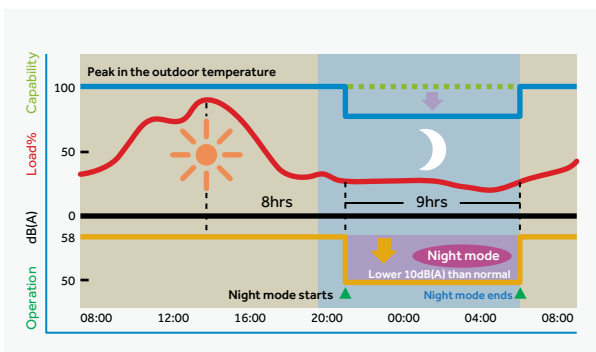

NEW DC INVERTER TWIN ROTARY COMPRESSOR

- A small torque change and a good dynamic balance of the system allows the unit to run smoothly with little vibration, low noise levels and increased efficiency
- Increased efficiency during part load operation

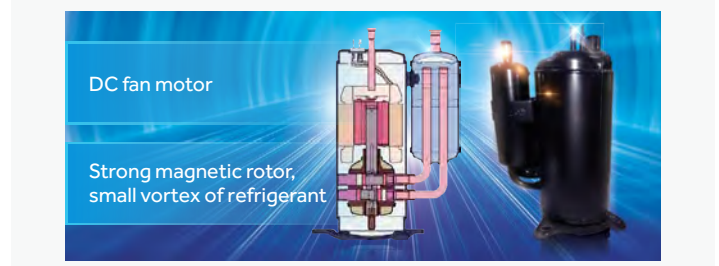

MRV S II - FEATURES

- 1 New aerodynamic fan
550mm super big diameter aerospace helix fan. lowering sound level by 3dB(A)
- 2 Enlarged air inlet path and spiral air outlet path.
Air flow direction follows the grill direction which reduces sound levels by 2-4 dB(A)
- 3 Automatic sound reduction capability. Night mode set by the PCB is 8dB(A) lower

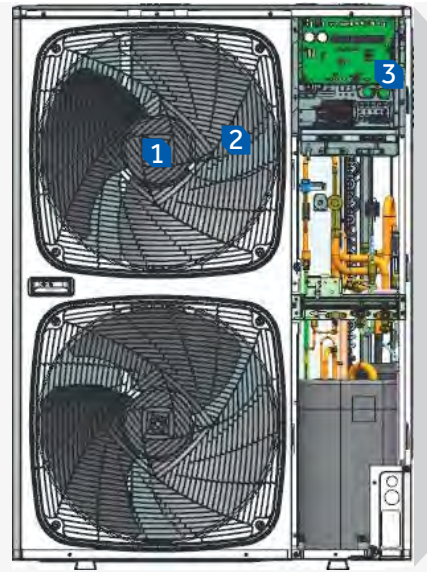

LOW SOUND OPERATION

- DC inverter compressor achieves a smoother operation and effectively reduces sound levels by eliminating the frequent start up of the compressor.
- Precision control achieved by vector inverter control
- Non-resonance motor brackets are used on the DC fan motor which ensures a smoother operation of the motor and reduces operating sound levels
- Larger fan diameter inspired by aviation design principles for quieter operation

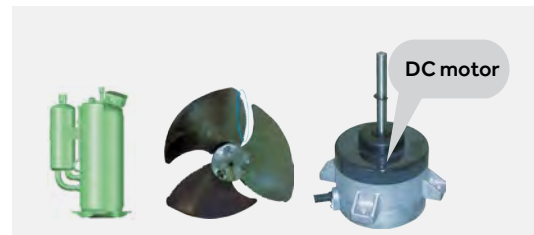

COMPACT SIDE DISCHARGE DESIGN

Side discharge design eliminates the need for additional ventilation hood compared with a top discharge unit, ideal for narrow spaces.



MRV S II - FEATURES

LONG PIPE LENGTH, INCREASED HEIGHT DROP

- Total pipe length: 300m
- Single pipe length: Max. 175m
- From outdoor to the first branch pipe: 135m
- From the first branch to the furthest indoor door unit: 40m
- Height drop: 50m(outdoor above)/40m (outdoor below)
- Height drop between indoor units: 15m



PARAMETER DISPLAY PANEL

The parameter display panel has been improved by moving it to the side of the unit. The parameter can be easily accessed by directly opening the protective cover for maintenance.

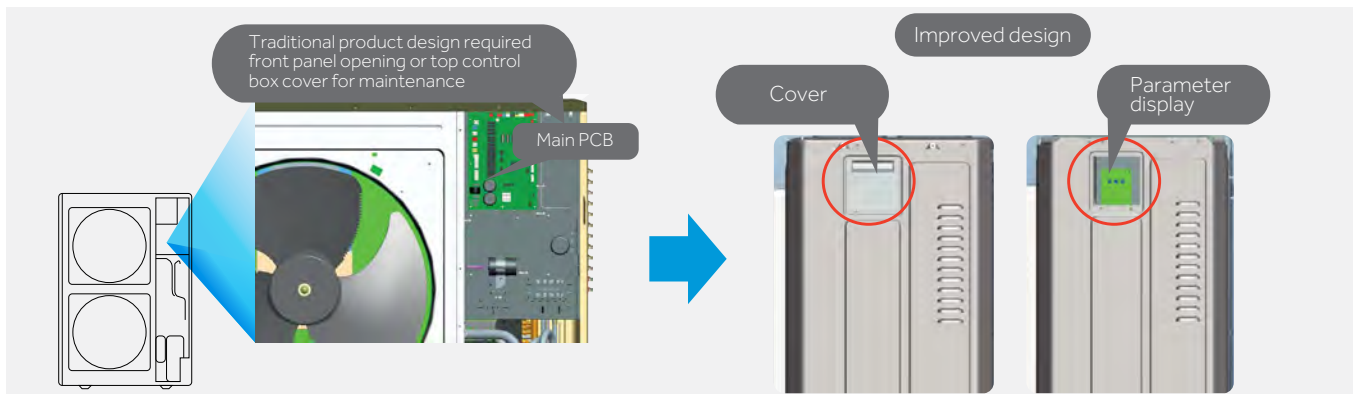

AUTOMATIC REFRIGERANT RECLAIM TECHNOLOGY

Set automatic refrigerant reclaim through the dip switch. The refrigerant in the indoor unit can be automatically returned to the outdoor unit. This is convenient during maintenance, reducing refrigerant waste, maintenance cost and time.

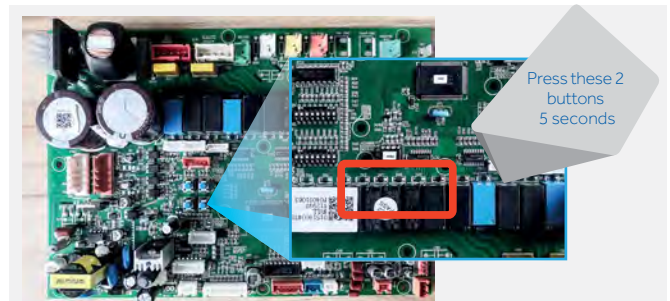

REFRIGERANT CONTROL TECHNOLOGY

Refrigerant control technology without high pressure accumulator, reduces the refrigerant volume and enhances operating efficiency.

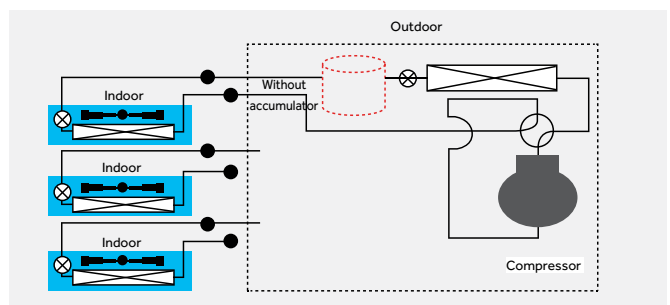

HIGH AND LOW DOUBLE PRESSURE SENSOR

- Double pressure sensor with PID control technology.
- Combining high speed communication to quick start the compressor with more precise control the temperature can be controlled with a precision of $\pm 0.5^{\circ}\text{C}$.

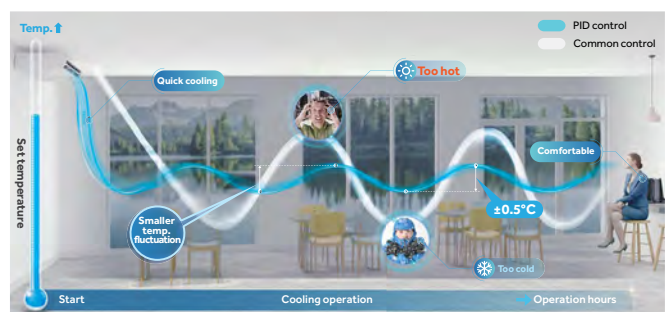

Outdoor Units with Frontal Discharge MRV S II



3-4-5 HP

AU042FNERA

AU052FNERA

Model			AU042FNERA	AU052FNERA
Capacity ^[1]	Power Class	HP	4	5
	Cooling	kW	12,10	14,00
	Heating	kW	12,10	14,00
Electrical parameters	Power supply	Ph/V/Hz	1/220-240/50/60	1/220-240/50/60
	Absorbed power - Cooling	kW	4,25	4,83
	Max absorbed current - Cooling	A	28,30	29,30
	Absorbed power - Heating	kW	4,10	5,00
	Max absorbed current - Heating	A	27,90	29,30
	EER energy class	/	2,85	2,80
	COP energy class	/	2,95	2,90
	SEER energy class (T1)	/	4,90	4,85
	SCOP energy class (T1)	/	3,50	3,55
	η _{s,hs,c} %	%	193	191
η _{s,hs,h} %	%	137	139	
Fan	Air flow (High)	m ³ /h	5400	5400
Pressure sound level	Sound pressure level (Cooling)	dB(A)	58	60
	Sound pressure level (Heating)	dB(A)	60	62
Dimensions	Unit Dimensions WxDxH	mm	950x370x965	950x370x965
	Packaged unit dimensions WxDxH	mm	1010x458x990	1010x458x990
Weight	Net/Shipping weight	kg	90/102	90/102
Compressor	Compressor type	/	Rotary Inverter	Rotary Inverter
	Motor Power	W	4130	4130
	Compressor quantity	/	1	1
Refrigerant	Refrigerant type	/	R410A	R410A
	Pre-charged refrigerant qty.	kg	3,30	3,30
Piping	Ø Liquid side refrigerant pipe	mm (inch)	9,52 (3/8)	9,52 (3/8)
	Ø Gas side refrigerant pipe	mm (inch)	15,88 (5/8)	15,88 (5/8)
	Maximum piping length	m	120	120
	Max linear piping length (Equivalent/Real)	m	70/60	70/60
	Std. drop between IU and OU	m	30/20	30/20
	Max. drop between IU *3	m	10	10
Connection ratio	Indoor / Outdoor Capacity Ratio	%	50-130	50-130
	Maximum number of connectable IUs	/	7	8
Working temp.	Cooling	°C	-5-50	-5-50
	Heating	°C	-15-21	-15-21

(*) The specifications indicated are obtained with the following test conditions: in Cooling mode, Indoor temperature of 27°C WB / 19°C DB and Outdoor temperature of 35°C WB / 24°C DB. In Heating mode, Indoor temperature of 20°C WB and Outdoor temperature of 7°C WB / 6°C DB

Outdoor Units with Frontal Discharge

MRV S II



4-6HP

AU042FPERA
AU052FPERA
AU062FPERA
AU041FPERA
AU051FPERA
AU061FPERA

Model			AU042FPERA	AU052FPERA	AU062FPERA	AU041FPERA	AU051FPERA	AU061FPERA
Capacity ^[1]	Power Class	HP	4	5	6	4	5	6
	Cooling	kW	12,10	14,00	15,50	12,10	14,00	15,50
	Heating	kW	12,10	14,00	15,50	12,10	14,00	15,50
Electrical parameters	Power supply	Ph/V/Hz	1/220-240/50/60	1/220-240/50/60	1/220-240/50/60	3/380-415/50/60	3/380-415/50/60	3/380-415/50/60
	Absorbed power - Cooling	kW	3,61	4,33	5,17	3,61	4,33	5,17
	Max absorbed current - Cooling	A	34,10	35,50	36,90	11,40	11,90	12,90
	Absorbed power - Heating	kW	3,23	3,76	5,00	3,23	3,76	5,00
	Max absorbed current - Heating	A	32,70	34,10	35,50	10,90	11,40	11,90
	EER energy class	/	3,35	3,23	3,00	3,35	3,23	3,00
	COP energy class	/	3,75	3,72	3,10	3,75	3,72	3,10
	SEER energy class (T1)	/	6,82	6,65	6,80	6,82	6,65	6,80
	SCOP energy class (T1)	/	4,05	4,11	4,05	4,05	4,11	4,05
	ηs,h %	%	270	263	269	270	263	269
ηs,h %	%	159	161	159	159	161	159	
Fan	Air flow (High)	m ³ /h	7200	7200	7200	7200	7200	7200
Pressure sound level	Sound pressure level (Cooling)	dB(A)	57	58	59	57	58	59
	Sound pressure level (Heating)	dB(A)	57	58	59	57	58	59
Dimensions	Unit Dimensions WxDxH	mm	950x370x1350	950x370x1350	950x370x1350	950x370x1350	950x370x1350	950x370x1350
	Packaged unit dimensions WxDxH	mm	1023x471x1420	1023x471x1420	1023x471x1420	1023x471x1420	1023x471x1420	1023x471x1420
Weight	Net/Shipping weight	kg	108/123	108/123	108/123	108/123	108/123	108/123
Compressor	Compressor type	/	Rotary Inverter	Rotary Inverter	Rotary Inverter	Rotary Inverter	Rotary Inverter	Rotary Inverter
	Motor Power	W	4130	4130	4130	4060	4060	4060
	Compressor quantity	/	1	1	1	1	1	1
Refrigerant	Refrigerant type	/	R410A	R410A	R410A	R410A	R410A	R410A
	Pre-charged refrigerant qty.	kg	4,00	4,00	4,00	4,00	4,00	4,00
Piping	Ø Liquid side refrigerant pipe	mm (inch)	9,52 (3/8)	9,52 (3/8)	9,52 (3/8)	9,52 (3/8)	9,52 (3/8)	9,52 (3/8)
	Ø Gas side refrigerant pipe	mm (inch)	15,88 (5/8)	15,88 (5/8)	15,88 (5/8)	15,88 (5/8)	15,88 (5/8)	15,88 (5/8)
	Maximum piping length	m	300	300	300	300	300	300
	Max linear piping length (Equivalent/Real)	m	175/150	175/150	175/150	175/150	175/150	175/150
	Std. drop between IU and OU	m	50	50	50	50	50	50
	Max. drop between IU *3	m	15	15	15	15	15	15
Connection ratio	Indoor / Outdoor Capacity Ratio	%	50-130	50-130	50-130	50-130	50-130	50-130
	Maximum number of connectable IUs	/	8	10	13	8	10	13
Working temp.	Cooling	°C	-5~50	-5~50	-5~50	-5~50	-5~50	-5~50
	Heating	°C	-20~27	-20~27	-20~27	-20~27	-20~27	-20~27

(*) The specifications indicated are obtained with the following test conditions: in Cooling mode, Indoor temperature of 27°C WB / 19°C DB and Outdoor temperature of 35°C WB / 24°C DB. In Heating mode, Indoor temperature of 20°C WB and Outdoor temperature of 7°C WB / 6°C DB

(a) With solder reduced from 22,22 to 19,05 for connecting the pipe to the unit valve accessory accompanying the product.

(b) The unit also works regularly with 9,52 diameter pipe. Requires 9,52>12,7 adapter to connect to the machine (not provided by Haier).

Outdoor Units with Frontal Discharge MRV S II



8-12HP

AU08NFKERA
AU10NFKERA
AU12NFKERA

Model			AU08NFKERA	AU10NFKERA	AU12NFKERA
Capacity ^[1]	Power Class	HP	8	10	12
	Cooling	kW	22,60	28,00	31,50
	Heating	kW	22,60	30,50	31,50
Electrical parameters	Power supply	Ph/V/Hz	3/380~415/50/60	3/380~415/50/60	3/380~415/50/60
	Absorbed power - Cooling	kW	6,95	8,67	11,54
	Max absorbed current - Cooling	A	19,00	23,80	25,40
	Absorbed power - Heating	kW	5,79	8,03	8,49
	Max absorbed current - Heating	A	18,00	22,60	24,20
	EER energy class	/	3,25	3,23	2,73
	COP energy class	/	3,90	3,80	3,71
	SEER energy class (T1)	/	7,67	7,65	7,47
	SCOP energy class (T1)	/	4,05	4,16	4,21
	η _{s,h} %	%	304	303	296
	η _{s,h} %	%	159	163	165
Fan	Air flow (High)	m ³ /h	10000	10000	10000
Pressure sound level	Sound pressure level (Cooling)	dB(A)	63	64	65
	Sound pressure level (Heating)	dB(A)	65	66	67
Dimensions	Unit Dimensions WxDxH	mm	1050x400x1636	1050x400x1636	1050x400x1636
	Packaged unit dimensions WxDxH	mm	1150x510x1790	1150x510x1790	1150x510x1790
Weight	Net/Shipping weight	kg	149/168	149/168	149/168
Compressor	Compressor type	/	Twin Rotary Inverter	Twin Rotary Inverter	Twin Rotary Inverter
	Motor Power	W	6270	6270	6270
	Compressor quantity	/	1	1	1
Refrigerant	Refrigerant type	/	R410A	R410A	R410A
	Pre-charged refrigerant qty.	kg	5,10	5,10	5,10
Piping	Ø Liquid side refrigerant pipe	mm (inch)	9,52 (3/8)	9,52 (3/8)	9,52 (3/8)
	Ø Gas side refrigerant pipe	mm (inch)	19,05 (3/4)	22,22 (7/8)	25,40 (1)
	MaMaximum piping length	m	300	300	300
	Max linear piping length (Equivalent/Real)	m	175/150	175/150	175/150
	Std. drop between IU and OU	m	50	50	50
	StMax. drop between IU *3	m	15	15	15
Connection ratio	Indoor / Outdoor Capacity Ratio	%	50~130	50~130	50~130
	Maximum number of connectable IUs	/	13	16	19
Working temp.	Cooling	°C	-5~48	-5~48	-5~48
	Heating	°C	-20~27	-20~27	-20~27

(*) The specifications indicated are obtained with the following test conditions: in Cooling mode, Indoor temperature of 27°C WB / 19°C DB and Outdoor temperature of 35°C WB / 24°C DB. In Heating mode, Indoor temperature of 20°C WB and Outdoor temperature of 7°C WB / 6°C DB

Outdoor Units with Frontal Discharge MRV S II

AU042FNERA AU052FNERA

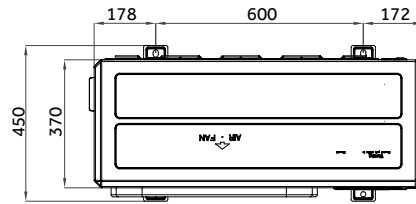
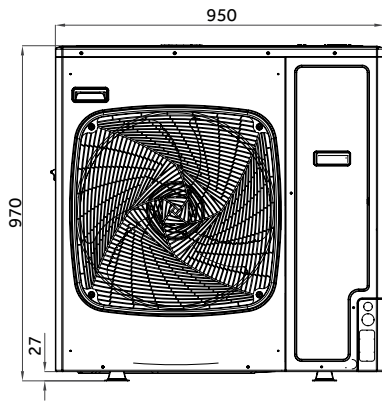

AU042FPERA AU052FPERA AU062FPERA AU04IFPERA AU05IFPERA AU06IFPERA

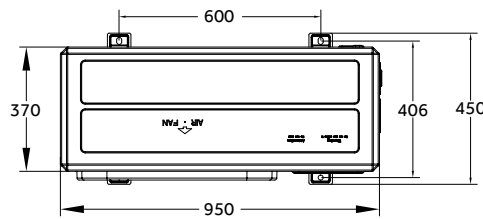
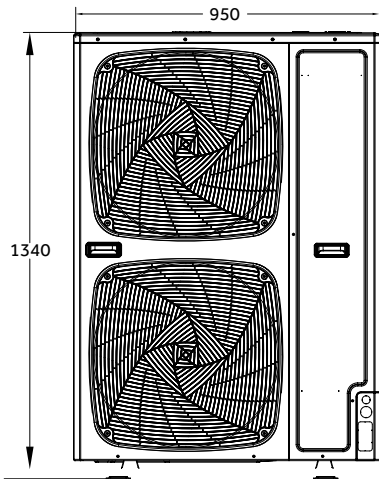

AU08NFKERA AU10NFKERA AU12NFKERA

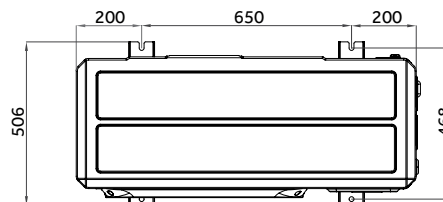
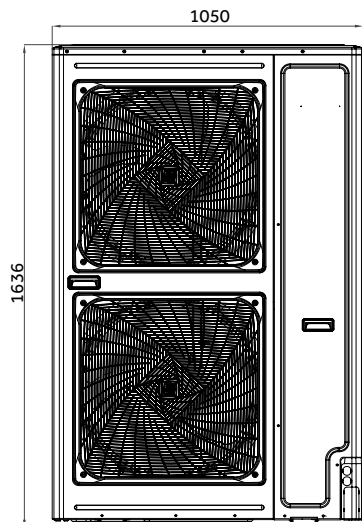





MRV5-H

DC INVERTER

Heat Pump
VRF Continuous
Heating System

MRV5-H

DC INVERTER



MRV 5-H CONTINUOUS HEATING, EVEN DURING DEFROST MODE.

MRV 5-H continuous heating VRF system by Haier adopts intelligent defrost technology according to the system pressure, coil temperature and humidity changes, coupled with the fan motor inspection technology to initiate automatic defrost mode.

Indoor temperature fluctuations are reduced by using direct defrosting technology and ensuring that in certain defrosting modes the four-way valve does not reverse direction giving you uninterrupted heating temperatures.



MRV5-H

DC INVERTER

ENHANCED VAPOR INJECTION TECHNOLOGY, LOW TEMPERATURE HEATING AND HIGH TEMPERATURE COOLING

The MRV 5-H unit adopts an EVI compressor, which can increase the circulation of the refrigerant by 15%, and improve the heating effect by 30% compared with standard compressor types. The heating operating temperature in winter can be -27°C , and the cooling operating temperature in summer can be 52°C .

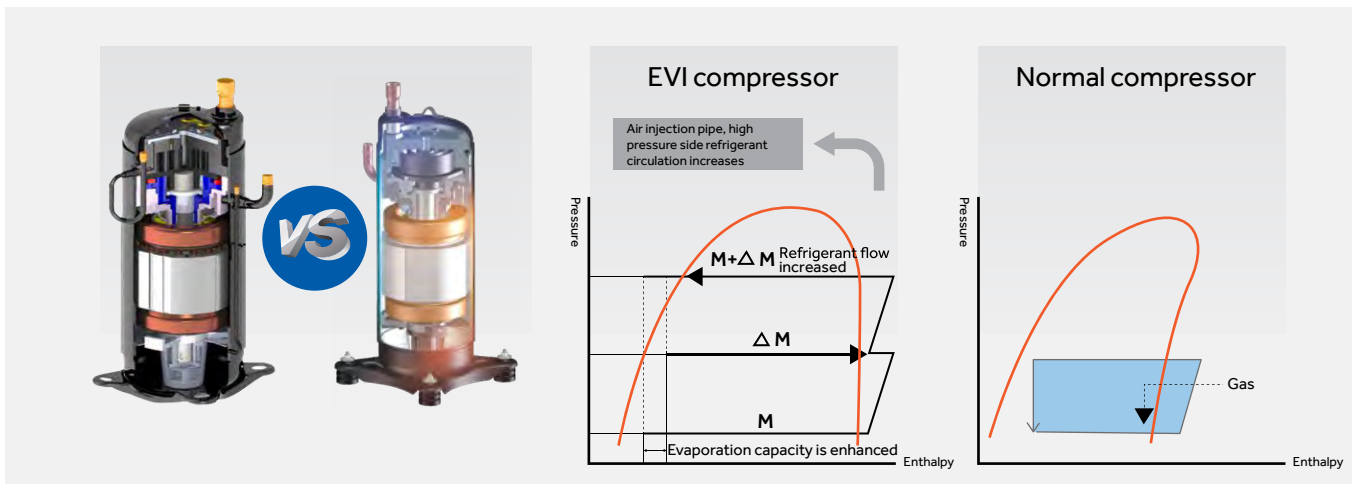

2 STAGE SUB-COOLING

Sub-cooling degree is up to 30°C . Improves the cooling and heating capacity.

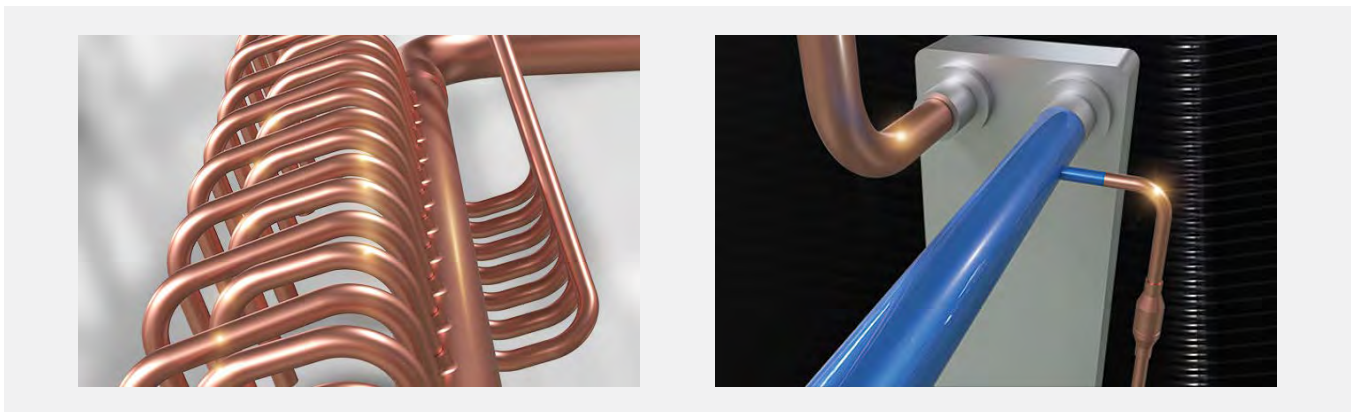

RELIABLE PERFORMANCE IN LOW TEMPERATURES

Compared with the standard series, the heating capacity in MRV 5-H is increased by 10% in the low temperature. For example, in the 8HP unit the heating capacity is 100% under -10°C environment temperature.

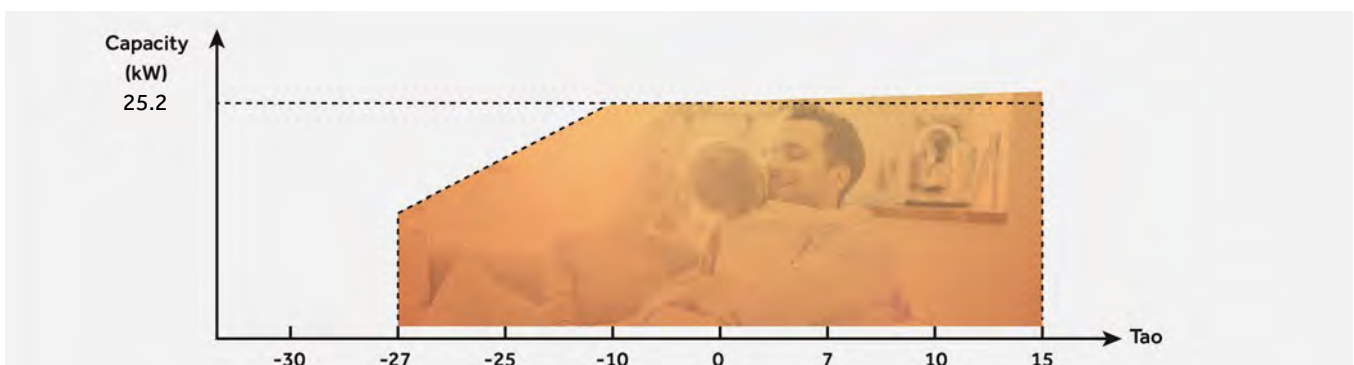

MRV5-H

DC INVERTER

WIDE RANGE OF POWER

Up to 26 HP with single module and up to 104 HP by combining up to 4 modules. Modules 8 to 16 HP are equipped with single fan, for maximum installation flexibility and a small footprint on the surface.



SMART LINK

Wireless connection and communication between indoor units.

- Labour saving
- Automatic network connection
- Convenient maintenance
- Stable performance
- Total Cost saving is estimated about 30%



TOTAL PIPE LENGTH 1000M, HEIGHT DROP 110M

- Max. total pipe length 1000m
- Max. actual pipe length 220m
- Max. equivalent pipe length 260m
- Max. drop between IDU&ODU / 90m (outdoor unit up) / 110m (outdoor unit down)
- Max. drop between IDU&IDU 30m*

* if the total pipe length is between 300m and 1100m or the drop between IDU and ODU more than 50m, please contact your local dealer.

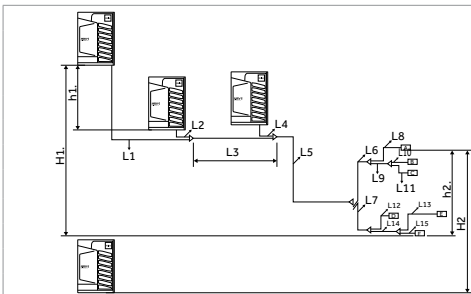
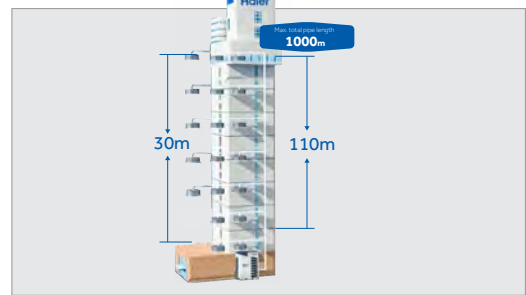

	Max. Length	Pipe in left figure
Single way total pipe length (=total liquid pipe length)	1000m	L1+L2+L3+L4+L5+L6+L7+L8 + L9+L10+L11+L12+L13+L14+L15
Single way max. pipe length (max. length between outdoor & indoor) actual length	220m	L1 + L3 + L5 + L7 + L14 + L13
Main pipe actual length (length between first gather pipe & first branch pipe)	130m	L5
Pipe length after first branch pipe (length between first branch & farthest indoor)	90m	L7+L13+L14
The distance between the nearest indoor unit and the farthest indoor	40m	L13+L14-L12
Pipe length among outdoor units (length between first gather pipe & farthest outdoor unit)	10m	L1+L3
Height difference between indoors	18	h2
Height difference between outdoors	5m	h1
Height difference between indoor & outdoor	Indoor below outdoor (between highest outdoor & lowest indoor)	50m H1
	Indoor above outdoor (between lowest outdoor & highest indoor)	40m H2

MRV5-H

DC INVERTER

DESIGN OF CONTROL CONDENSER WITH ELECTRONIC EXPANSION VALVE

The condenser is controlled by two electronic expansion valves, which can reasonably use the heat exchanger area according to the demand of IDU heat exchange temperature and distribute the refrigerant flow according to the load demand, to ensure high-performance heat exchange efficiency.

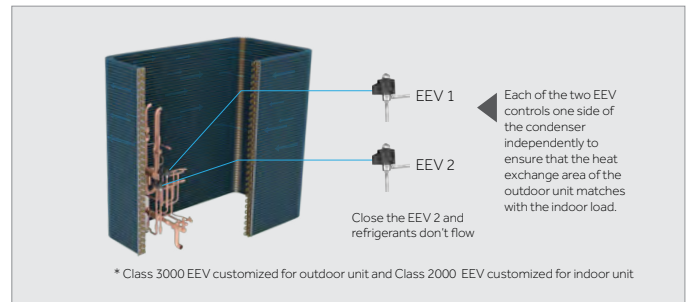

SUPER EFFICIENCY WITH FULL DC INVERTER COMPRESSOR

Matches up inverter with stepless compressor, the durability and stability of the compressor are guaranteed, fault can be reduced.

Each compressor has an inbuilt oil temperature sensor and a discharge temperature sensor, detecting the discharge temperature and oil temperature of compressor, which in coordination with the compressor frequency and the EEV control, to ensure exhaust heat and oil temperature superheat kept within the optimal range. Ensure that the oil dilution is maintained at a safe level at all times.

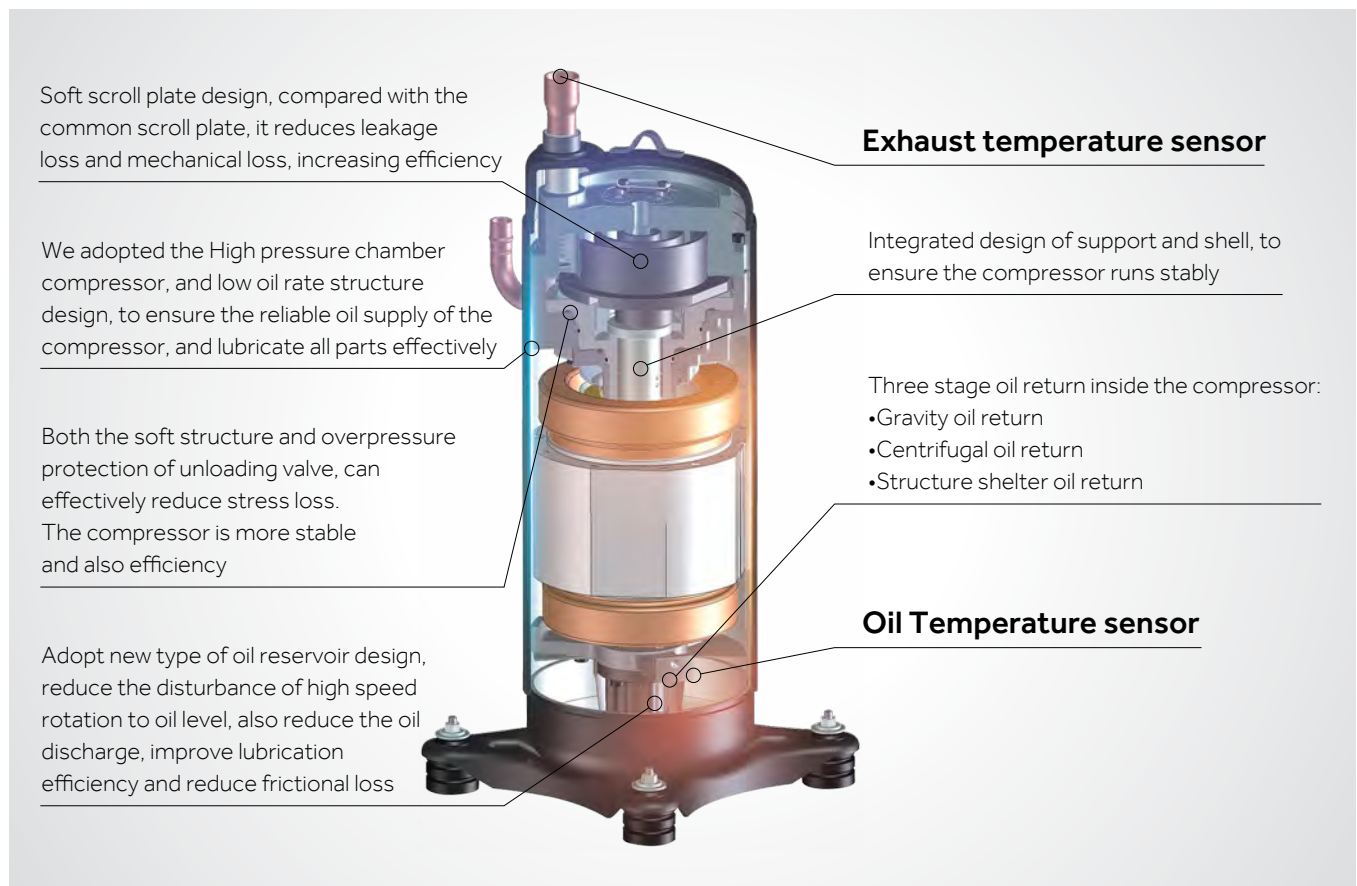

MRV5-H

DC INVERTER

AUTOMATIC OIL BALANCING

When pairing multiple modules with each other, it is not necessary to provide the oil equalisation pipe, as the lubrication system inside each module is self-controlled.



NEW 4-SIDED CONTINUOUS HEAT EXCHANGER COIL

Outdoor unit matches efficient variable-speed DC-motor. driven by sine wave. wider efficiency range and torque range. motor efficiency is increased by 17%. air fan of outdoor unit can achieve 0-91Hz stepless frequency.



NEW CERTIFIED AND REGISTERED DESIGN

The unit is equipped with a hinged technical door that allows access to the electronic parts in a simple and secure way. The electronic part in turn is mounted on a mobile base that can also be opened for access to the refrigeration part of the unit. This line of products includes new and generous fans with an aerodynamic profile tested in the wind tunnel, with a diameter of 700 mm to move large air flows in maximum tranquillity and quietness.



TEMPERATURE APPROACHING TECHNOLOGY

The main problem of an ordinary inverter VRF system lies in that its compressor starts and stops frequently. stopping when the room temperature reaches the setting temperature and restarting when the same becomes higher than the setting temperature. Though the inverter technology has improved such a problem greatly, the energy consumption caused by system restart is still a problem that cannot be ignored. Haier MRV 5 series units adopts the temperature approaching technology, which enables the VRF system to maintain a low-frequency operating state all the time when the room temperature is close to the setting temperature but doesn't reach the setting temperature, thus avoiding the energy waste caused by frequent on/off.

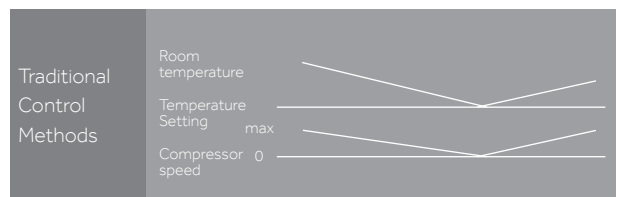

38% Power Consumption Reduced

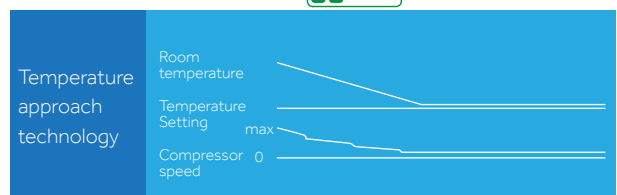

MRV5-H

DC INVERTER

WIDE OPERATION TEMPERATURE

The heating operation temperature can be as low as -23°C outdoor ambient temperature. The cooling operation temperature can reach 50°C outdoor temperature, allowing it to operate in extreme temperatures.



PRECISE TEMPERATURE CONTROL AT ±0.5°C

With twin pressure sensors and twin EEVS, the refrigerant volume can be adjusted automatically to realise precise temperature control, improving indoor comfort.



INTELLIGENT TRIPLE BACKUP OPERATION TECHNOLOGY

- For the double-compressor system, if one compressor is in breakdown, the other compressor can be put into backup operation immediately to ensure the user needs.
- For the multi-module combination, in case of breakdown of one outdoor unit, this unit can be interrupted from the system so that the other modules can continue to operate.
- Super-long backup operation time, which can reach up to 8 hours.



MULTIPLE MODES AVAILABLE TO MEET THE NEEDS OF DIFFERENT USERS



Operation mode:
Cooling priority, heating priority, cooling only, heating only, and VIP priority



Silent mode:
Seven-position silent mode available (night time silent mode and six-position silent mode)



Static pressure mode:
No static pressure mode, low static pressure mode, medium static pressure mode, and high static pressure mode

MRV5-H

DC INVERTER

ROTARY ELECTRIC CONTROL BOX DESIGN

Rotary electric control box design gives access to the inside of the machine without having to dismantle the whole casing, for faster and more convenient maintenance.



4-WAY PIPE CONNECTION

You can freely choose the front, back, left side, right side of the unit to connect the pipe, easy for install and design.

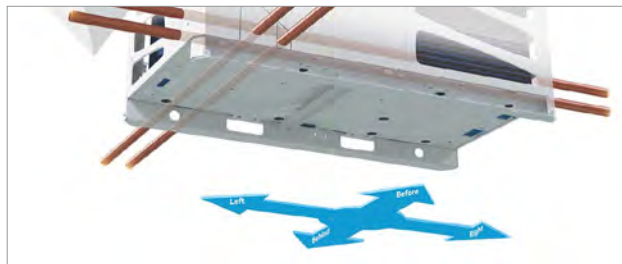

AUTOMATIC SNOW CLEARING AND DUST REMOVAL FUNCTION

According to the ash accumulation on the outdoor heat exchanger, the unit will blow away the dust, according to the reverse operation of the fan.



PIPING REFRIGERANT STORAGE TECHNOLOGY

Advanced refrigerant control technology, the refrigerant is stored in the indoor and outdoor machine piping, remove the high pressure tank, less refrigerant filling in unit, high efficiency.



AUTO ADDRESSING INDOOR UNITS

The ODU can automatically address the indoor units through the module on PCB, and the controller can search and set the address of the indoor unit, making the setup and maintenance of the system quick and easy.

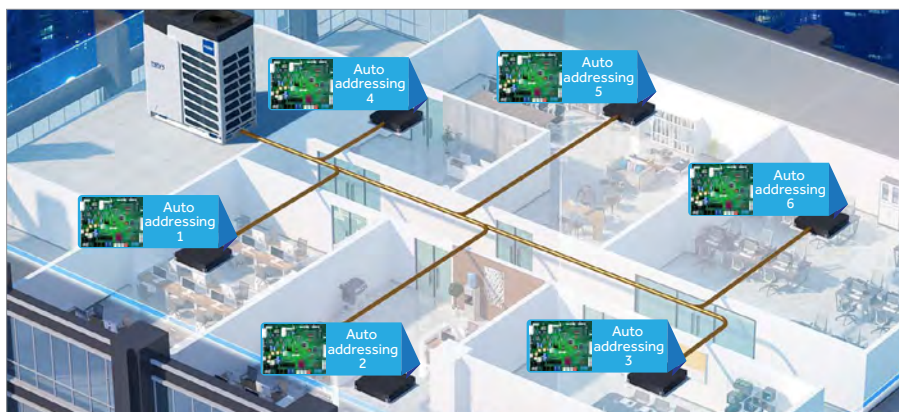

110PA EXTERNAL STATIC PRESSURE DESIGN

The static pressure of the air outlet is up to 110Pa, which can meet the cooling effect of the layered arrangement of the outdoor unit.



Installation of duct



The outdoor unit is hidden inside the building without affecting the overall image of the building

MRV5-H

DC INVERTER

SMARTLINK - WIRELESS WI-FI COMMUNICATION

Wi-Fi "Smartlink", the new and exclusive wireless communication system between outdoor and indoor units (optional)



"SMARTLINK" WI-FI FEATURES

- As an alternative to the classic digital communication cable, which is required to make all indoor units talk to their outdoor units, you can install these wireless radio accessories with ZigBee technology on each indoor and outdoor unit.
- At the time of activation, the indoor units begin to dialog with each other creating a stable network of coded signals that bounce between the various internal units until they reach the outdoor unit and vice versa. Each indoor unit works as a signal repeater. With this system, communication is guaranteed even to the most distant indoor unit, and in the presence of walls or other obstacles.
- When an indoor unit is in maintenance, the signal of the unit is lost, this does not affect the normal functioning of the other units.
- The system is set up by the Haier service centres in the start-up phase through a special application (APP) that can be installed on smartphones or tablets (it does not require access to the Internet, as it works on a local WIFI network)



Radio adapter for the indoor unit to be connected to the respective electronic board.

The use of the 'Smartlink' system is useful where it is impossible to reach all the units with a cable. It can be expensive in economic terms and takes time to roll out a cable, intervening on an existing redevelopment plant where the existing layout of the wired communication is not known and where there was a problem on the existing cable (damage etc.) and it is not possible to detect the problem.



8-16HP

AV08NMVETA
AV10NMVETA
AV12NMVETA
AV14NMVETA
AV16NMVETA

Model		AV08NMVETA	AV10NMVETA	AV12NMVETA	AV14NMVETA	AV16NMVETA
Capacity						
Power Class	HP	8	10	12	14	16
Cooling	kW	25,20	28,00	33,50	40,00	45,00
Heating	kW	25,20	28,00	33,50	40,00	45,00
Electrical Parameters						
Power supply	Ph-V/Hz	"3/380-400/50/60 (5 wires L1+L2+L3+N+T)"		"3/380-400/50/60 (5 wires L1+L2+L3+N+T)"		"3/380-400/50/60 (5 wires L1+L2+L3+N+T)"
Absorbed power - Cooling	kW	6,24	7,37	10,15	11,94	13,24
Max absorbed power - Cooling	kW	14,30	15,10	16,32	17,58	20,69
Absorbed current in cooling	A	10,53	12,44	17,14	20,16	22,34
Max absorbed current - Cooling	A	23,81	25,14	27,17	29,27	34,50
Absorbed power - Heating	kW	5,73	6,51	8,59	10,00	11,25
Max absorbed power - Heating	kW	11,69	12,19	12,69	16,10	19,56
Absorbed current in heating	A	9,67	10,99	14,50	16,88	18,99
Max absorbed current - Heating	A	19,47	20,30	21,13	26,81	32,57
EER energy class	W/W	4,04	3,80	3,30	3,35	3,40
COP energy class	W/W	4,53	4,43	4,02	4,12	4,12
SEER energy class	W/W	7,25	7,09	6,69	6,60	6,36
SCOP energy class	W/W	4,41	4,31	4,31	4,12	4,05
η _{s,c} %		287	281	265	261	251
η _{s,h} %		173	169	169	162	159
Ventilation						
Air flow (High)	m ³ /h	11000	11000	12000	13500	13500
Sound pressure level (High)	dB(A)	56	56	59	59	60
Sound power level (High)	dB(A)	81	82	88	88	88
Installation - Dimensions - Components						
Unit Dimensions WxDxH	mm	980x750x1690				
Packaged unit dimensions WxDxH	mm	1070x850x1858				
Net weight / Gross weight	Kg	255/280				
Compressor type		DC Inverter Scroll	DC Inverter Scroll	DC Inverter Scroll	DC Inverter Scroll	DC Inverter Scroll
Quantity and type of the compressor	No.	1INV	1INV	1INV	1INV	1INV
Refrigerant type		R410A	R410A	R410A	R410A	R410A
Pre-charged refrigerant qty.	Kg	10	10	10	10	10
Ø Liquid side refrigerant pipe	mm (inch)	9,52 (3/8)	9,52 (3/8)	12,70 (1/2)	12,70 (1/2)	12,70 (1/2)
Ø Gas side refrigerant pipe	mm (inch)	19,05 (3/4)	22,22 (7/8)	25,40 (1)	25,40 (1)	28,58 (1-1/8)
Maximum piping length	m	1000	1000	1000	1000	1000
Max linear piping length (Equivalent/Real)	m	260/220	260/220	260/220	260/220	260/220
Max. drop between IU and OU (O.U. down/up)*1	m	110/90	110/90	110/90	110/90	110/90
Max. drop between IU and OU (O.U. down/up)*2	m	50/40	50/40	50/40	50/40	50/40
Max. drop between IU *3	m	30	30	30	30	30
Std. drop between IU *4	m	18	18	18	18	18
Static Pressure Fans	Pa	110	110	110	110	110
Connectable Indoor Capacity Ratio						
Indoor / Outdoor Capacity Ratio	%	50-130	50-130	50-130	50-130	50-130
Maximum number of connectable IUs	No.	13	16	20	24	27
External Temperature Operating Limits						
Cooling	°C	-5-52	-5-52	-5-52	-5-52	-5-52
Heating	°C	-27-21	-27-21	-27-21	-27-21	-27-21

Outdoor Units

MRV5-H

DC INVERTER



18-26HP

AV18NMVETA
AV20NMVETA
AV22NMVETA
AV24NMVETA
AV26NMVETA

		AV18NMVETA	AV20NMVETA	AV22NMVETA	AV24NMVETA	AV26NMVETA
Capacity						
Power Class	HP	18	20	22	24	26
Cooling	kW	50,40	56,00	61,50	68,00	73,50
Heating	kW	50,40	56,00	61,50	68,00	73,50
Electrical Parameters						
Power supply	Ph-V/Hz	"3/380-400/50/60 (5 wires L1+L2+L3+N+T)"		"3/380-400/50/60 (5 wires L1+L2+L3+N+T)"		"3/380-400/50/60 (5 wires L1+L2+L3+N+T)"
Absorbed power - Cooling	kW	15,60	16,62	20,16	22,67	36,75
Max absorbed power - Cooling	kW	25,90	28,91	31,82	32,81	37,80
Absorbed current in cooling	A	26,34	28,05	34,03	37,65	59,24
Max absorbed current - Cooling	A	40,30	46,30	51,91	54,12	61,91
Absorbed power - Heating	kW	13,19	14,66	18,64	19,43	26,25
Max absorbed power - Heating	kW	21,93	24,70	25,69	30,40	32,45
Absorbed current in heating	A	22,27	24,75	31,46	32,80	44,32
Max absorbed current - Heating	A	36,51	41,13	42,78	50,62	54,03
EER energy class	W/W	3,23	3,37	3,05	3,00	2,00
COP energy class	W/W	3,93	3,93	3,40	3,61	2,88
SEER energy class	W/W	6,78	6,75	6,54	5,83	4,90
SCOP energy class	W/W	4,15	4,20	4,21	4,17	3,50
$\eta_{s,c}$ %		268	267	259	230	193
$\eta_{s,h}$ %		163	165	165	164	137
Ventilation						
Air flow (High)	m ³ /h	17000	17000	18000	18000	19000
Sound pressure level (High)	dB(A)	61	61	61	62	62
Sound power level (High)	dB(A)	88	88	88	90	90
Installation - Dimensions - Components						
Unit Dimensions WxDxH	mm	1410x750x1690				
Packaged unit dimensions WxDxH	mm	1515x850x1858				
Net weight / Gross weight	Kg	385/410				
Compressor type		DC Inverter Scroll	DC Inverter Scroll	DC Inverter Scroll	DC Inverter Scroll	DC Inverter Scroll
Quantity and type of the compressor	No.	2INV	2INV	2INV	2INV	2INV
Refrigerant type		R410A	R410A	R410A	R410A	R410A
Pre-charged refrigerant qty.	Kg	10	10	10	10	10
Ø Liquid side refrigerant pipe	mm (inch)	15,88 (5/8)	15,88 (5/8)	15,88 (5/8)	15,88 (5/8)	15,88 (5/8)
Ø Gas side refrigerant pipe	mm (inch)	28,58 (1-1/8)	28,58 (1-1/8)	28,58 (1-1/8)	28,58 (1-1/8)	28,58 (1-1/8)
Maximum piping length	m	1000	1000	1000	1000	1000
Max linear piping length (Equivalent/Real)	m	260/220	260/220	260/220	260/220	260/220
Max. drop between IU and OU (O.U. down/up)*1	m	110/90	110/90	110/90	110/90	110/90
Max. drop between IU and OU (O.U. down/up)*2	m	50/40	50/40	50/40	50/40	50/40
Max. drop between IU *3	m	30	30	30	30	30
Std. drop between IU *4	m	18	18	18	18	18
Static Pressure Fans	Pa	110	110	110	110	110
Connectable Indoor Capacity Ratio						
Indoor / Outdoor Capacity Ratio	%	50-130	50-130	50-130	50-130	50-130
Maximum number of connectable IUs	No.	30	33	36	40	43
External Temperature Operating Limits						
Cooling	°C	-5-52	-5-52	-5-52	-5-52	-5-52
Heating	°C	-27-21	-27-21	-27-21	-27-21	-27-21



28-32 HP

AV14NMVETA

AV16NMVETA

Model		AV28NMVETA AV14NMVETA AV14NMVETA	AV30NMVETA AV14NMVETA AV16NMVETA	AV32NMVETA AV16NMVETA AV16NMVETA
Capacity				
Power Class	HP	28	30	32
Cooling	kW	80,00	85,00	90,00
Heating	kW	80,00	85,00	90,00
Electrical Parameters				
Power supply	Ph-V/Hz	"3/380-400/50/60 (5 wires L1+L2+L3+N+T)"	"3/380-400/50/60 (5 wires L1+L2+L3+N+T)"	"3/380-400/50/60 (5 wires L1+L2+L3+N+T)"
Absorbed power - Cooling	kW	23,88	25,18	26,47
Max absorbed power - Cooling	kW	35,16	38,27	41,38
Absorbed current in cooling	A	40,32	42,50	44,69
Max absorbed current - Cooling	A	58,54	63,77	69,00
Absorbed power - Heating	kW	20,00	21,25	22,50
Max absorbed power - Heating	kW	32,20	35,66	39,12
Absorbed current in heating	A	33,76	35,87	37,98
Max absorbed current - Heating	A	53,61	59,38	65,14
EER energy class	W/W	3,35	3,38	3,40
COP energy class	W/W	4,12	4,12	4,12
SEER energy class	W/W	6,60	6,36	6,36
SCOP energy class	W/W	4,12	4,05	4,05
ηs,c %		261	251	251
ηs,h %		162	159	159
Ventilation				
Air flow (High)	m3/h	27000	27000	27000
Sound pressure level (High)	dB(A)	62	62,5	63
Sound power level (High)	dB(A)	91	91	91
Installation - Dimensions - Components				
Unit Dimensions WxDxH	mm	980x750x1690+980x750x1690		
Packaged unit dimensions WxDxH	mm	1070x850x1858+1070x850x1858		
Net weight / Gross weight	Kg	255/280+255/280		
Compressor type		DC Inverter Scroll	DC Inverter Scroll	DC Inverter Scroll
Quantity and type of the compressor	No.	2INV	2INV	2INV
Refrigerant type		R410A	R410A	R410A
Pre-charged refrigerant qty.	Kg	20	20	20
Ø Liquid side refrigerant pipe	mm (inch)	15,88 (5/8)	19,05 (3/4)	19,05 (3/4)
Ø Gas side refrigerant pipe	mm (inch)	28,58 (1-1/8)	31,80 (1-1/4)	31,80 (1-1/4)
Maximum piping length	m	1000	1000	1000
Max linear piping length (Equivalent/Real)	m	260/220	260/220	260/220
Max. drop between IU and OU (O.U. down/up)*1	m	110/90	110/90	110/90
Max. drop between IU and OU (O.U. down/up)*2	m	50/40	50/40	50/40
Max. drop between IU *3	m	30	30	30
Std. drop between IU *4	m	18	18	18
Static Pressure Fans	Pa	110	110	110
Connectable Indoor Capacity Ratio				
Indoor / Outdoor Capacity Ratio	%	50-130	50-130	50-130
Maximum number of connectable IUs	No.	47	50	53
External Temperature Operating Limits				
Cooling	°C	-5-52	-5-52	-5-52
Heating	°C	-27-21	-27-21	-27-21

Outdoor Units

MRV5-H

DC INVERTER



34-38HP

AV14NMVETA

AV18NMVETA

AV20NMVETA

Model		AV34NMVETA AV16NMVETA AV16NMVETA	AV36NMVETA AV18NMVETA AV18NMVETA	AV38NMVETA AV18NMVETA AV20NMVETA
Capacity				
Power Class	HP	34	36	38
Cooling	kW	95,40	100,80	106,40
Heating	kW	95,40	100,80	106,40
Electrical Parameters				
Power supply	Ph-V/Hz	"3/380-400/50/60 (5 wires L1+L2+L3+N+T)"	"3/380-400/50/60 (5 wires L1+L2+L3+N+T)"	"3/380-400/50/60 (5 wires L1+L2+L3+N+T)"
Absorbed power - Cooling	kW	28,84	31,20	32,22
Max absorbed power - Cooling	kW	46,59	51,80	54,81
Absorbed current in cooling	A	48,68	52,67	54,39
Max absorbed current - Cooling	A	74,80	80,60	86,60
Absorbed power - Heating	kW	24,44	26,39	27,85
Max absorbed power - Heating	kW	41,49	43,86	46,63
Absorbed current in heating	A	41,27	44,55	47,02
Max absorbed current - Heating	A	69,08	73,03	77,64
EER energy class	W/W	3,31	3,23	3,30
COP energy class	W/W	4,02	3,93	3,93
SEER energy class	W/W	6,36	6,78	6,75
SCOP energy class	W/W	4,05	4,15	4,15
η _{s,c} %		251	268	267
η _{s,h} %		159	163	163
Ventilation				
Air flow (High)	m ³ /h	27000	34000	34000
Sound pressure level (High)	dB(A)	63,5	64	64
Sound power level (High)	dB(A)	91	91	91
Installation - Dimensions - Components				
Unit Dimensions WxDxH	mm	980x750x1690+1410x750x1690	1410x750x1690+1410x750x1690	
Packaged unit dimensions WxDxH	mm	1070x850x1858+1485x850x1858	1485x850x1858+1485x850x1858	
Net weight / Gross weight	Kg	255/280+385/410	385/410+385/410	
Compressor type		DC Inverter Scroll	DC Inverter Scroll	DC Inverter Scroll
Quantity and type of the compressor	No.	3INV	4INV	4INV
Refrigerant type		R410A	R410A	R410A
Pre-charged refrigerant qty.	Kg	20	20	20
Ø Liquid side refrigerant pipe	mm (inch)	19,05 (3/4)	19,05 (3/4)	19,05 (3/4)
Ø Gas side refrigerant pipe	mm (inch)	31,80 (1-1/4)	38,10 (1-1/2)	38,10 (1-1/2)
Maximum piping length	m	1000	1000	1000
Max linear piping length (Equivalent/Real)	m	260/220	260/220	260/220
Max. drop between IU and OU (O.U. down/up)*1	m	110/90	110/90	110/90
Max. drop between IU and OU (O.U. down/up)*2	m	50/40	50/40	50/40
Max. drop between IU *3	m	30	30	30
Std. drop between IU *4	m	18	18	18
Static Pressure Fans	Pa	110	110	110
Connectable Indoor Capacity Ratio				
Indoor / Outdoor Capacity Ratio	%	50-130	50-130	50-130
Maximum number of connectable IUs	No.	56	59	63
External Temperature Operating Limits				
Cooling	°C	-5-52	-5-52	-5-52
Heating	°C	-27-21	-27-21	-27-21

The data in this catalogue is purely indicative as the data may vary. Please be advised to check the accuracy of the data with the supplier before purchasing products.



40-48HP

AV20NMVETA

AV22NMVETA

AV24NMVETA

Model		AV40NMVETA AV20NMVETA AV20NMVETA	AV42NMVETA AV20NMVETA AV22NMVETA	AV44NMVETA AV22NMVETA AV22NMVETA	AV46NMVETA AV22NMVETA AV24NMVETA	AV48NMVETA AV24NMVETA AV24NMVETA
Capacity						
Power Class	HP	40	42	44	46	48
Cooling	kW	112,00	117,50	123,00	129,50	136,00
Heating	kW	112,00	117,50	123,00	129,50	136,00
Electrical Parameters						
Power supply	Ph-V/Hz	"3/380-400/50/60 (5 wires L1+L2+L3+N+T)"	"3/380-400/50/60 (5 wires L1+L2+L3+N+T)"	"3/380-400/50/60 (5 wires L1+L2+L3+N+T)"	"3/380-400/50/60 (5 wires L1+L2+L3+N+T)"	"3/380-400/50/60 (5 wires L1+L2+L3+N+T)"
Absorbed power - Cooling	kW	33,23	36,78	40,32	42,83	45,34
Max absorbed power - Cooling	kW	57,82	60,73	63,64	64,63	65,62
Absorbed current in cooling.	A	56,11	62,09	68,07	71,68	75,30
Max absorbed current - Cooling	A	92,60	98,21	103,82	106,03	108,24
Absorbed power - Heating	kW	29,32	33,30	37,27	38,06	38,86
Max absorbed power - Heating	kW	49,40	50,39	51,38	56,09	60,80
Absorbed current in heating	A	49,50	56,21	62,92	64,26	65,60
Max absorbed current - Heating	A	82,25	83,90	85,55	93,39	101,23
EER energy class	W/W	3,37	3,19	3,05	3,02	3,00
COP energy class	W/W	3,93	3,64	3,40	3,50	3,61
SEER energy class	W/W	6,75	6,54	6,54	5,83	5,83
SCOP energy class	W/W	4,20	4,20	4,21	4,17	4,17
$\eta_{s,c}$ %		267	259	259	230	230
$\eta_{s,h}$ %		165	165	165	164	164
Ventilation						
Air flow (High)	m ³ /h	34000	35000	36000	36000	36000
Sound pressure level (High)	dB(A)	64	64	64	64,5	65
Sound power level (High)	dB(A)	91	92	93	93	93
Installation - Dimensions - Components						
Unit Dimensions WxDxH	mm	1410x750x1690+1410x750x1690				
Packaged unit dimensions WxDxH	mm	1485x850x1858+1485x850x1858				
Net weight / Gross weight	Kg	385/410+385/410				
Compressor type		DC Inverter Scroll	DC Inverter Scroll	DC Inverter Scroll	DC Inverter Scroll	DC Inverter Scroll
Quantity and type of the compressor	No.	4INV	4INV	4INV	4INV	4INV
Refrigerant type		R410A	R410A	R410A	R410A	R410A
Pre-charged refrigerant qty.	Kg	20	20	20	20	20
Ø Liquid side refrigerant pipe	mm (inch)	19,05 (3/4)	19,05 (3/4)	19,05 (3/4)	19,05 (3/4)	19,05 (3/4)
Ø Gas side refrigerant pipe	mm (inch)	38,10 (1-1/2)	38,10 (1-1/2)	38,10 (1-1/2)	38,10 (1-1/2)	38,10 (1-1/2)
Maximum piping length	m	1000	1000	1000	1000	1000
Max linear piping length (Equivalent/Real)	m	260/220	260/220	260/220	260/220	260/220
Standard height difference between IU and OU	m	110/90	110/90	110/90	110/90	110/90
Standard height difference between IU and IU	m	50/40	50/40	50/40	50/40	50/40
Max. drop between IU *3	m	30	30	30	30	30
Std. drop between IU *4		18	18	18	18	18
Static Pressure Fans	Pa	110	110	110	110	110
Connectable Indoor Capacity Ratio						
Indoor / Outdoor Capacity Ratio	%	50-130	50-130	50-130	50-130	50-130
Maximum number of connectable IUs	No.	64	64	64	64	64
External Temperature Operating Limits						
Cooling	°C	-5-52	-5-52	-5-52	-5-52	-5-52
Heating	°C	-27-21	-27-21	-27-21	-27-21	-27-21

Outdoor Units

MRV5-H
DC INVERTER

50-56HP

AV18NMVETA
AV20NMVETA
AV24NMVETA
AV26NMVETA

Model		AV50NMVETA AV24NMVETA AV26NMVETA	AV52NMVETA AV26NMVETA AV26NMVETA	AV54NMVETA AV18NMVETA AV18NMVETA AV18NMVETA	AV56NMVETA AV18NMVETA AV18NMVETA AV20NMVETA
Capacity					
Power Class	HP	50	52	54	56
Cooling	kW	141,50	147,00	151,20	156,80
Heating	kW	141,50	147,00	151,20	156,80
Electrical Parameters					
Power supply	Ph-V/Hz	"3/380-400/50/60 (5 wires L1+L2+L3+N+T)"	"3/380-400/50/60 (5 wires L1+L2+L3+N+T)"	"3/380-400/50/60 (5 wires L1+L2+L3+N+T)"	"3/380-400/50/60 (5 wires L1+L2+L3+N+T)"
Absorbed power - Cooling	kW	59,42	73,50	46,80	47,82
Max absorbed power - Cooling	kW	70,61	75,60	77,70	80,71
Absorbed current in cooling.	A	96,89	118,48	79,01	80,73
Max absorbed current - Cooling	A	116,03	123,82	120,90	126,90
Absorbed power - Heating	kW	45,68	52,50	39,58	41,05
Max absorbed power - Heating	kW	62,85	64,90	65,79	68,56
Absorbed current in heating	A	77,11	88,63	66,82	69,30
Max absorbed current - Heating	A	104,65	108,06	109,54	114,15
EER energy class	W/W	2,38	2,00	3,23	3,28
COP energy class	W/W	3,19	2,88	3,93	3,93
SEER energy class	W/W	4,90	4,90	6,78	6,75
SCOP energy class	W/W	3,50	3,50	4,15	4,15
$\eta_{s,c}$ %		193	193	268	267
$\eta_{s,h}$ %		137	137	163	163
Ventilation					
Air flow (High)	m ³ /h	37000	38000	51000	51000
Sound pressure level (High)	dB(A)	65	65	65,8	65,8
Sound power level (High)	dB(A)	93	93	93	93
Installation - Dimensions - Components					
Unit Dimensions WxDxH	mm	1410x750x1690+1410x750x1690		1410x750x1690+1410x750x1690+1410x750x1690	
Packaged unit dimensions WxDxH	mm	1485x850x1858+1485x850x1858		1485x850x1858+1485x850x1858+1485x850x1858	
Net weight / Gross weight	Kg	385/410+385/410		385/410+385/410+385/410	
Compressor type		DC Inverter Scroll	DC Inverter Scroll	DC Inverter Scroll	DC Inverter Scroll
Quantity and type of the compressor	No.	4INV	4INV	6INV	6INV
Refrigerant type		R410A	R410A	R410A	R410A
Pre-charged refrigerant qty.	Kg	20	20	30	30
Ø Liquid side refrigerant pipe	mm (inch)	19,05 (3/4)	19,05 (3/4)	19,05 (3/4)	19,05 (3/4)
Ø Gas side refrigerant pipe	mm (inch)	38,10 (1-1/2)	38,10 (1-1/2)	38,10 (1-1/2)	38,10 (1-1/2)
Maximum piping length	m	1000	1000	1000	1000
Max linear piping length (Equivalent/Real)	m	260/220	260/220	260/220	260/220
Standard height difference between IU and OU	m	110/90	110/90	110/90	110/90
Standard height difference between IU and IU	m	50/40	50/40	50/40	50/40
Max. drop between IU *3	m	30	30	30	30
Std. drop between IU *4	m	18	18	18	18
Static Pressure Fans	Pa	110	110	110	110
Connectable Indoor Capacity Ratio					
Indoor / Outdoor Capacity Ratio	%	50-130	50-130	50-130	50-130
Maximum number of connectable IUs	No.	64	64	64	64
External Temperature Operating Limits					
Cooling	°C	-5-52	-5-52	-5-52	-5-52
Heating	°C	-27-21	-27-21	-27-21	-27-21



58-64HP

AV18NMVETA

AV20NMVETA

AV22NMVETA

Model		AV58NMVETA AV18NMVETA AV20NMVETA AV20NMVETA	AV60NMVETA AV20NMVETA AV20NMVETA AV20NMVETA	AV62NMVETA AV20NMVETA AV20NMVETA AV22NMVETA	AV64NMVETA AV20NMVETA AV22NMVETA AV22NMVETA
Capacity					
Power Class	HP	58	60	62	64
Cooling	kW	162,40	168,00	173,50	179,00
Heating	kW	162,40	168,00	173,50	179,00
Electrical Parameters					
Power supply	Ph-V/Hz	"3/380-400/50/60 (5 wires L1+L2+L3+N+T)"		"3/380-400/50/60 (5 wires L1+L2+L3+N+T)"	
Absorbed power - Cooling	kW	48,83	49,85	53,39	56,94
Max absorbed power - Cooling	kW	83,72	86,73	89,64	92,55
Absorbed current in cooling	A	82,44	84,16	90,14	96,12
Max absorbed current - Cooling	A	132,90	138,90	144,51	150,12
Absorbed power - Heating	kW	42,51	42,98	47,96	51,93
Max absorbed power - Heating	kW	71,33	74,10	75,09	76,08
Absorbed current in heating	A	71,77	74,25	80,96	87,67
Max absorbed current - Heating	A	118,76	123,38	125,03	126,68
EER energy class	W/W	3,33	3,37	3,25	3,14
COP energy class	W/W	3,93	3,93	3,73	3,55
SEER energy class	W/W	6,75	6,75	6,54	6,54
SCOP energy class	W/W	4,15	4,20	4,20	4,20
ηs,c %		267	267	259	259
ηs,h %		163	165	165	165
Ventilation					
Air flow (High)	m³/h	51000	51000	52000	53000
Sound pressure level (High)	dB(A)	65,8	65,8	65,8	65,8
Sound power level (High)	dB(A)	93	93	93,5	94
Installation - Dimensions - Components					
Unit Dimensions WxDxH	mm	1410x750x1690+1410x750x1690+1410x750x1690			
Packaged unit dimensions WxDxH	mm	1485x850x1858+1485x850x1858+1485x850x1858			
Net weight / Gross weight	Kg	385/410+385/410+385/410			
Compressor type		DC Inverter Scroll	DC Inverter Scroll	DC Inverter Scroll	DC Inverter Scroll
Quantity and type of the compressor	No.	6INV	6INV	6INV	6INV
Refrigerant type		R410A	R410A	R410A	R410A
Pre-charged refrigerant qty.	Kg	30	30	30	30
Ø Liquid side refrigerant pipe	mm (inch)	19,05 (3/4)	19,05 (3/4)	19,05 (3/4)	19,05 (3/4)
Ø Gas side refrigerant pipe	mm (inch)	41,30 (1-5/8)	41,30 (1-5/8)	41,30 (1-5/8)	41,30 (1-5/8)
Maximum piping length	m	1000	1000	1000	1000
Max linear piping length (Equivalent/Real)	m	260/220	260/220	260/220	260/220
Max. drop between IU and OU (O.U. down/up)*1	m	110/90	110/90	110/90	110/90
Std. drop between IU and OU (O.U. up/down)*2	m	50/40	50/40	50/40	50/40
Max. drop between IU *3	m	30	30	30	30
Std. drop between IU *4	m	18	18	18	18
Static Pressure Fans	Pa	110	110	110	110
Connectable Indoor Capacity Ratio					
Indoor / Outdoor Capacity Ratio	%	50-130	50-130	50-130	50-130
Maximum number of connectable IUs	No.	64	64	64	64
External Temperature Operating Limits					
Cooling	°C	-5-52	-5-52	-5-52	-5-52
Heating	°C	-27-21	-27-21	-27-21	-27-21

Outdoor Units

MRV5-H

DC INVERTER



66-72HP

AV22NMVETA

AV24NMVETA

Model		AV66NMVETA AV22NMVETA AV22NMVETA AV22NMVETA	AV68NMVETA AV22NMVETA AV22NMVETA AV24NMVETA	AV70NMVETA AV22NMVETA AV24NMVETA AV24NMVETA	AV72NMVETA AV24NMVETA AV24NMVETA AV24NMVETA
Capacity					
Power Class	HP	66	68	70	72
Cooling	kW	184,50	191,00	197,50	204,00
Heating	kW	184,50	191,00	197,50	204,00
Electrical Parameters					
Power supply	Ph-V/Hz	"3/380-400/50/60 (5 wires L1+L2+L3+N+T)"	"3/380-400/50/60 (5 wires L1+L2+L3+N+T)"	"3/380-400/50/60 (5 wires L1+L2+L3+N+T)"	"3/380-400/50/60 (5 wires L1+L2+L3+N+T)"
Absorbed power - Cooling	kW	60,48	62,99	65,50	68,01
Max absorbed power - Cooling	kW	95,46	96,45	97,44	98,43
Absorbed current in cooling	A	102,10	105,72	109,33	112,95
Max absorbed current - Cooling	A	155,73	157,94	160,15	162,36
Absorbed power - Heating	kW	55,91	56,70	57,49	58,29
Max absorbed power - Heating	kW	77,08	81,78	86,49	91,20
Absorbed current in heating	A	94,39	95,72	97,06	98,40
Max absorbed current - Heating	A	128,33	136,17	144,01	151,85
EER energy class	W/W	3,05	3,03	3,02	3,00
COP energy class	W/W	3,40	3,47	3,54	3,61
SEER energy class	W/W	6,54	5,83	5,83	5,83
SCOP energy class	W/W	4,21	4,17	4,17	4,17
η _{s,c} %		259	230	230	230
η _{s,h} %		165	164	164	164
Ventilation					
Air flow (High)	m ³ /h	54000	54000	54000	54000
Sound pressure level (High)	dB(A)	65,8	66	66,5	66,8
Sound power level (High)	dB(A)	95	95	95	95
Installation - Dimensions - Components					
Unit Dimensions WxDxH	mm	1410x750x1690+1410x750x1690+1410x750x1690			
Packaged unit dimensions WxDxH	mm	1485x850x1858+1485x850x1858+1485x850x1858			
Net weight / Gross weight	Kg	385/410+385/410+385/410			
Compressor type		DC Inverter Scroll	DC Inverter Scroll	DC Inverter Scroll	DC Inverter Scroll
Quantity and type of the compressor	No.	6INV	6INV	6INV	6INV
Refrigerant type		R410A	R410A	R410A	R410A
Pre-charged refrigerant qty.	Kg	30	30	30	30
Ø Liquid side refrigerant pipe	mm	19,05 (3/4)	22,20 (7/8)	22,20 (7/8)	22,20 (7/8)
Ø Gas side refrigerant pipe	mm	41,30 (1-5/8)	44,50 (1-3/4)	44,50 (1-3/4)	44,50 (1-3/4)
Maximum piping length	m	1000	1000	1000	1000
Max linear piping length (Equivalent/Real)	m	260/220	260/220	260/220	260/220
Max. drop between IU and OU (O.U. down/up)*1	m	110/90	110/90	110/90	110/90
Std. drop between IU and OU (O.U. up/down)*2		50/40	50/40	50/40	50/40
Max. drop between IU *3	m	30	30	30	30
Std. drop between IU *4		18	18	18	18
Static Pressure Fans	Pa	110	110	110	110
Connectable Indoor Capacity Ratio					
Indoor / Outdoor Capacity Ratio	%	50-130	50-130	50-130	50-130
Maximum number of connectable IUs	No.	64	64	64	64
External Temperature Operating Limits					
Cooling	°C	-5-52	-5-52	-5-52	-5-52
Heating	°C	-27-21	-27-21	-27-21	-27-21



74-78HP

AV24NMVETA

AV26NMVETA

Model		AV74NMVETA AV24NMVETA AV24NMVETA AV26NMVETA	AV76NMVETA AV24NMVETA AV26NMVETA AV26NMVETA	AV78NMVETA AV26NMVETA AV26NMVETA AV26NMVETA
Capacity				
Power Class	HP	74	76	78
Cooling	kW	209,50	215,00	220,50
Heating	kW	209,50	215,00	220,50
Electrical Parameters				
Power supply	Ph-V/Hz	"3/380-400/50/60 (5 wires L1+L2+L3+N+T)"	"3/380-400/50/60 (5 wires L1+L2+L3+N+T)"	"3/380-400/50/60 (5 wires L1+L2+L3+N+T)"
Absorbed power - Cooling	kW	82,09	96,17	110,25
Max absorbed power - Cooling	kW	103,42	108,41	113,40
Absorbed current in cooling	A	134,54	156,13	177,72
Max absorbed current - Cooling	A	170,15	177,94	185,73
Absorbed power - Heating	kW	65,11	71,93	78,75
Max absorbed power - Heating	kW	93,25	95,30	97,35
Absorbed current in heating	A	109,91	121,43	132,95
Max absorbed current - Heating	A	155,26	158,67	162,09
EER energy class	W/W	2,55	2,24	2,00
COP energy class	W/W	3,31	3,08	2,88
SEER energy class	W/W	4,90	4,90	4,90
SCOP energy class	W/W	3,50	3,50	3,50
η _{s,c} %		193	193	193
η _{s,h} %		137	137	137
Ventilation				
Air flow (High)	m ³ /h	55000	56000	57000
Sound pressure level (High)	dB(A)	66,8	66,8	66,8
Sound power level (High)	dB(A)	95	95	95
Installation - Dimensions - Components				
Unit Dimensions WxDxH	mm	1410x750x1690+1410x750x1690+1410x750x1690		
Packaged unit dimensions WxDxH	mm	1485x850x1858+1485x850x1858+1485x850x1858		
Net weight / Gross weight	Kg	385/410+385/410+385/410		
Compressor type		DC Inverter Scroll	DC Inverter Scroll	DC Inverter Scroll
Quantity and type of the compressor	No.	6INV	6INV	6INV
Refrigerant type		R410A	R410A	R410A
Pre-charged refrigerant qty.	Kg	30	30	30
Ø Liquid side refrigerant pipe	mm	22,20 (7/8)	22,20 (7/8)	22,20 (7/8)
Ø Gas side refrigerant pipe	mm	44,50 (1-3/4)	44,50 (1-3/4)	44,50 (1-3/4)
Maximum piping length	m	1000	1000	1000
Max linear piping length (Equivalent/Real)	m	260/220	260/220	260/220
Max. drop between IU and OU (O.U. down/up)*1	m	110/90	110/90	110/90
Std. drop between IU and OU (O.U. up/down)*2		50/40	50/40	50/40
Max. drop between IU *3	m	30	30	30
Std. drop between IU *4		18	18	18
Static Pressure Fans	Pa	110	110	110
Connectable Indoor Capacity Ratio				
Indoor / Outdoor Capacity Ratio	%	50-130	50-130	50-130
Maximum number of connectable IUs	No.	64	64	64
External Temperature Operating Limits				
Cooling	°C	-5-52	-5-52	-5-52
Heating	°C	-27-21	-27-21	-27-21

Outdoor Units

MRV5-H
DC INVERTER

80-86HP

AV20NMVETA

AV22NMVETA

Model		AV80NMVETA AV20NMVETA AV20NMVETA AV20NMVETA AV20NMVETA	AV82NMVETA AV20NMVETA AV20NMVETA AV20NMVETA AV22NMVETA	AV84NMVETA AV20NMVETA AV20NMVETA AV22NMVETA AV22NMVETA	AV86NMVETA AV20NMVETA AV22NMVETA AV22NMVETA AV22NMVETA
Capacity					
Power Class	HP	80	82	84	86
Cooling	kW	224,00	229,50	235,00	240,50
Heating	kW	224,00	229,50	235,00	240,50
Electrical Parameters					
Power supply	Ph-V/Hz	"3/380-400/50/60 (5 wires L1+L2+L3+N+T)"	"3/380-400/50/60 (5 wires L1+L2+L3+N+T)"	"3/380-400/50/60 (5 wires L1+L2+L3+N+T)"	"3/380-400/50/60 (5 wires L1+L2+L3+N+T)"
Absorbed power - Cooling	kW	66,47	70,01	73,55	77,10
Max absorbed power - Cooling	kW	115,64	118,55	121,46	124,37
Absorbed current in cooling	A	112,21	118,19	124,18	130,16
Max absorbed current - Cooling	A	185,20	190,81	196,42	202,03
Absorbed power - Heating	kW	58,64	62,62	66,59	70,57
Max absorbed power - Heating	kW	98,80	99,79	100,78	101,78
Absorbed current in heating	A	98,99	105,71	112,42	119,13
Max absorbed current - Heating	A	164,50	166,15	167,81	169,46
EER energy class	W/W	3,37	3,28	3,19	3,12
COP energy class	W/W	3,93	3,78	3,64	3,51
SEER energy class	W/W	6,75	6,54	6,54	6,54
SCOP energy class	W/W	4,20	4,20	4,20	4,20
η _{s,c} %		267	259	259	259
η _{s,h} %		165	165	165	165
Ventilation					
Air flow (High)	m ³ /h	68000	69000	70000	71000
Sound pressure level (High)	dB(A)	67	67	67	67
Sound power level (High)	dB(A)	94	95	95	96
Installation - Dimensions - Components					
Unit Dimensions WxDxH	mm	1410x750x1690+1410x750x1690+1410x750x1690+1410x750x1690			
Packaged unit dimensions WxDxH	mm	1485x850x1858+1485x850x1858+1485x850x1858+1485x850x1858			
Net weight / Gross weight	Kg	385/410+385/410+385/410+385/410			
Compressor type		DC Inverter Scroll	DC Inverter Scroll	DC Inverter Scroll	DC Inverter Scroll
Quantity and type of the compressor	No.	8INV	8INV	8INV	8INV
Refrigerant type		R410A	R410A	R410A	R410A
Pre-charged refrigerant qty.	Kg	40	40	40	40
Ø Liquid side refrigerant pipe	mm	22,20 (7/8)	22,20 (7/8)	22,20 (7/8)	25,40 (1)
Ø Gas side refrigerant pipe	mm	44,50 (1-3/4)	44,50 (1-3/4)	44,50 (1-3/4)	50,80 (2)
Maximum piping length	m	1000	1000	1000	1000
Max linear piping length (Equivalent/Real)	m	260/220	260/220	260/220	260/220
Max. drop between IU and OU (O.U. down/up)*1	m	110/90	110/90	110/90	110/90
Std. drop between IU and OU (O.U. up/down)*2		50/40	50/40	50/40	50/40
Max. drop between IU *3	m	30	30	30	30
Std. drop between IU *4		18	18	18	18
Static Pressure Fans	Pa	110	110	110	110
Connectable Indoor Capacity Ratio					
Indoor / Outdoor Capacity Ratio	%	50-130	50-130	50-130	50-130
Maximum number of connectable IUs	No.	64	64	64	64
External Temperature Operating Limits					
Cooling	°C	-5-52	-5-52	-5-52	-5-52
Heating	°C	-27-21	-27-21	-27-21	-27-21



88-96HP

AV22NMVETA

AV24NMVETA

Model		AV88NMVETA AV22NMVETA AV22NMVETA AV22NMVETA AV22NMVETA	AV90NMVETA AV22NMVETA AV22NMVETA AV22NMVETA AV24NMVETA	AV92NMVETA AV22NMVETA AV22NMVETA AV24NMVETA AV24NMVETA	AV94NMVETA AV22NMVETA AV24NMVETA AV24NMVETA AV24NMVETA	AV96NMVETA AV24NMVETA AV24NMVETA AV24NMVETA AV24NMVETA
Capacity						
Power Class	HP	88	90	92	94	96
Cooling	kW	246,00	252,50	259,00	265,50	272,00
Heating	kW	246,00	252,50	259,00	265,50	272,00
Electrical Parameters						
Power supply	Ph-V/Hz	"3/380-400/50/60 (5 wires L1+L2+L3+N+T)"	"3/380-400/50/60 (5 wires L1+L2+L3+N+T)"	"3/380-400/50/60 (5 wires L1+L2+L3+N+T)"	"3/380-400/50/60 (5 wires L1+L2+L3+N+T)"	"3/380-400/50/60 (5 wires L1+L2+L3+N+T)"
Absorbed power - Cooling	kW	80,64	83,15	85,66	88,17	90,68
Max absorbed power - Cooling	kW	127,28	128,27	129,26	130,25	131,24
Absorbed current in cooling	A	136,14	139,75	143,37	146,98	150,60
Max absorbed current - Cooling	A	207,64	209,85	212,06	214,27	216,48
Absorbed power - Heating	kW	74,55	75,34	76,13	76,92	77,71
Max absorbed power - Heating	kW	102,77	107,48	112,18	116,89	121,60
Absorbed current in heating	A	125,85	127,19	128,52	129,86	131,20
Max absorbed current - Heating	A	171,11	178,95	186,79	194,63	202,46
EER energy class	W/W	3,05	3,04	3,02	3,01	3,00
COP energy class	W/W	3,40	3,45	3,50	3,56	3,61
SEER energy class	W/W	6,54	5,83	5,83	5,83	5,83
SCOP energy class	W/W	4,21	4,17	4,17	4,17	4,17
ηs,c %		259	230	230	230	230
ηs,h %		165	164	164	164	164
Ventilation						
Air flow (High)	m ³ /h	72000	72000	72000	72000	72000
Sound pressure level (High)	dB(A)	67	67,5	67,5	68	68
Sound power level (High)	dB(A)	96	96	96	96	96
Installation - Dimensions - Components						
Unit Dimensions WxDxH	mm	1410x750x1690+1410x750x1690+1410x750x1690+1410x750x1690				
Packaged unit dimensions WxDxH	mm	1485x850x1858+1485x850x1858+1485x850x1858+1485x850x1858				
Net weight / Gross weight	Kg	385/410+385/410+385/410+385/410				
Compressor type		DC Inverter Scroll	DC Inverter Scroll	DC Inverter Scroll	DC Inverter Scroll	DC Inverter Scroll
Quantity and type of the compressor	No.	8INV	8INV	8INV	8INV	8INV
Refrigerant type		R410A	R410A	R410A	R410A	R410A
Pre-charged refrigerant qty.	Kg	40	40	40	40	40
Ø Liquid side refrigerant pipe	mm (inch)	25,40 (1)	25,40 (1)	25,40 (1)	25,40 (1)	25,40 (1)
Ø Gas side refrigerant pipe	mm (inch)	50,80 (2)	50,80 (2)	50,80 (2)	50,80 (2)	50,80 (2)
Maximum piping length	m	1000	1000	1000	1000	1000
Max linear piping length (Equivalent/Real)	m	260/220	260/220	260/220	260/220	260/220
Max. drop between IU and OU (O.U. down/up)*1	m	110/90	110/90	110/90	110/90	110/90
Std. drop between IU and OU (O.U. up/down)*2		50/40	50/40	50/40	50/40	50/40
Max. drop between IU *3	m	30	30	30	30	30
Std. drop between IU *4		18	18	18	18	18
Static Pressure Fans	Pa	110	110	110	110	110
Connectable Indoor Capacity Ratio						
Indoor / Outdoor Capacity Ratio	%	50-130	50-130	50-130	50-130	50-130
Maximum number of connectable IUs	No.	64	64	64	64	64
External Temperature Operating Limits						
Cooling	°C	-5-52	-5-52	-5-52	-5-52	-5-52
Heating	°C	-27-21	-27-21	-27-21	-27-21	-27-21

Outdoor Units

MRV5-H

DC INVERTER



98-104HP

AV24NMVETA

AV26NMVETA

Model		AV98NMVETA AV24NMVETA AV24NMVETA AV24NMVETA AV26NMVETA	AV100NMVETA AV24NMVETA AV24NMVETA AV26NMVETA AV26NMVETA	AV102NMVETA AV24NMVETA AV26NMVETA AV26NMVETA AV26NMVETA	AV104NMVETA AV26NMVETA AV26NMVETA AV26NMVETA AV26NMVETA
Capacity					
Power Class	HP	98	100	102	104
Cooling	kW	277,50	283,00	288,50	294,00
Heating	kW	277,50	283,00	288,50	294,00
Electrical Parameters					
Power supply	Ph-V/Hz	"3/380-400/50/60 (5 wires L1+L2+L3+N+T)"	"3/380-400/50/60 (5 wires L1+L2+L3+N+T)"	"3/380-400/50/60 (5 wires L1+L2+L3+N+T)"	"3/380-400/50/60 (5 wires L1+L2+L3+N+T)"
Absorbed power - Cooling	kW	104,76	118,84	132,92	147,00
Max absorbed power - Cooling	kW	136,23	141,22	146,21	151,20
Absorbed current in cooling	A	172,19	193,78	215,37	236,96
Max absorbed current - Cooling	A	224,27	232,06	239,85	247,64
Absorbed power - Heating	kW	84,54	91,36	98,18	105,00
Max absorbed power - Heating	kW	123,65	125,70	127,75	129,80
Absorbed current in heating	A	142,71	154,23	165,75	177,26
Max absorbed current - Heating	A	205,88	209,29	212,70	216,12
EER energy class	W/W	2,65	2,38	2,17	2,00
COP energy class	W/W	3,38	3,19	3,02	2,88
SEER energy class	W/W	4,90	4,90	4,90	4,90
SCOP energy class	W/W	3,50	3,50	3,50	3,50
η _{s,c} %		193	193	193	193
η _{s,h} %		137	137	137	137
Ventilation					
Air flow (High)	m ³ /h	73000	74000	75000	76000
Sound pressure level (High)	dB(A)	68	68	68	68
Sound power level (High)	dB(A)	96	96	96	96
Installation - Dimensions - Components					
Unit Dimensions WxDxH	mm	1410x750x1690+1410x750x1690+1410x750x1690+1410x750x1690			
Packaged unit dimensions WxDxH	mm	1485x850x1858+1485x850x1858+1485x850x1858+1485x850x1858			
Net weight / Gross weight	Kg	385/410+385/410+385/410+385/410			
Compressor type		DC Inverter Scroll	DC Inverter Scroll	DC Inverter Scroll	DC Inverter Scroll
Quantity and type of the compressor	No.	8INV	8INV	8INV	8INV
Refrigerant type		R410A	R410A	R410A	R410A
Pre-charged refrigerant qty.	Kg	40	40	40	40
Ø Liquid side refrigerant pipe	mm	25,40 (1)	25,40 (1)	25,40 (1)	25,40 (1)
Ø Gas side refrigerant pipe	mm	54,10 (2-1/8)	54,10 (2-1/8)	54,10 (2-1/8)	54,10 (2-1/8)
Maximum piping length	m	1000	1000	1000	1000
Max linear piping length (Equivalent/Real)	m	260/220	260/220	260/220	260/220
Max. drop between IU and OU (O.U. down/up)*1	m	110/90	110/90	110/90	110/90
Std. drop between IU and OU (O.U. up/down)*2		50/40	50/40	50/40	50/40
Max. drop between IU *3	m	30	30	30	30
Std. drop between IU *4		18	18	18	18
Static Pressure Fans	Pa	110	110	110	110
Connectable Indoor Capacity Ratio					
Indoor / Outdoor Capacity Ratio	%	50-130	50-130	50-130	50-130
Maximum number of connectable IUs	No.	64	64	64	64
External Temperature Operating Limits					
Cooling	°C	-5-52	-5-52	-5-52	-5-52
Heating	°C	-27-21	-27-21	-27-21	-27-21



MRV5-RC

DC INVERTER

Full DC Inverter
3-Pipe Heat
Recovery Systems

MRV5-RC DC INVERTER

Simultaneous heating and cooling available with a 3-pipe heat recovery outdoor unit

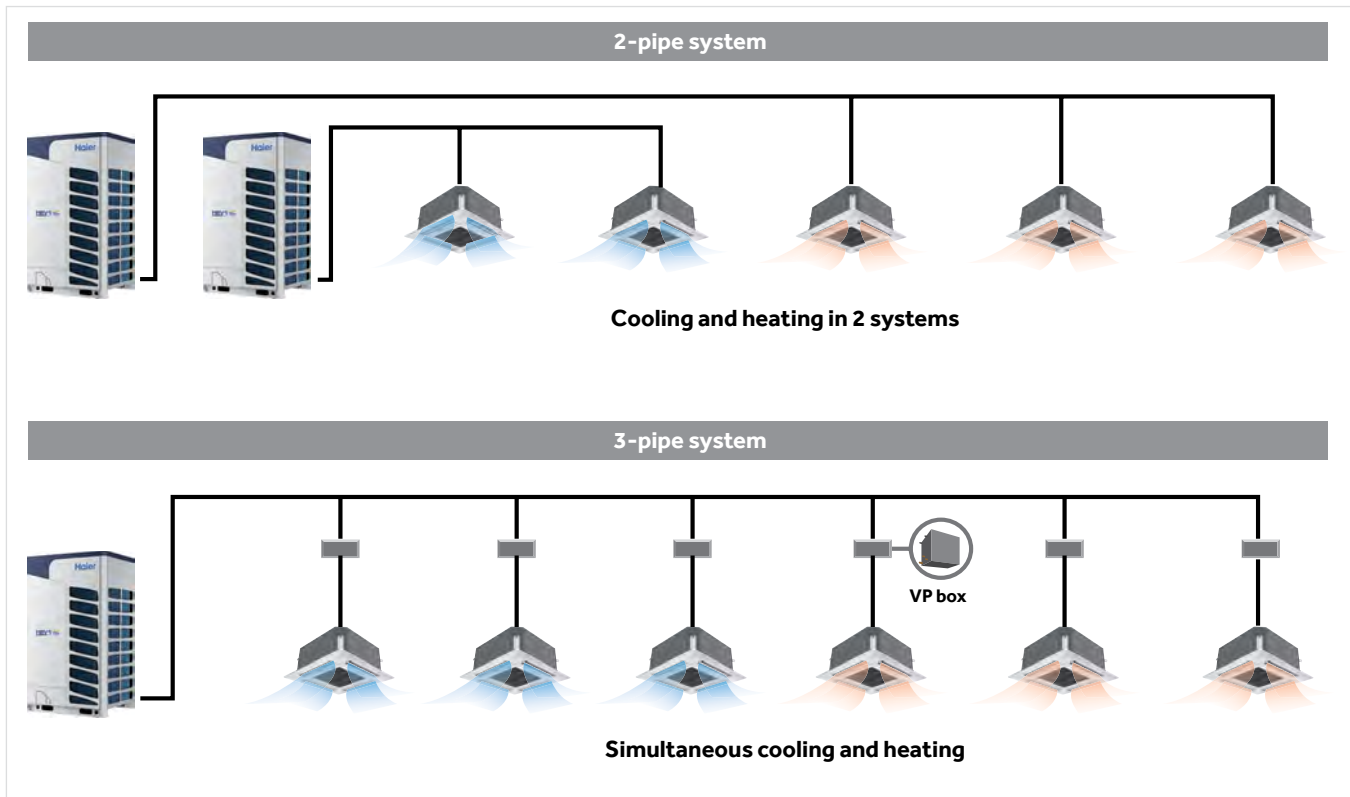

Various modes of simultaneous operation

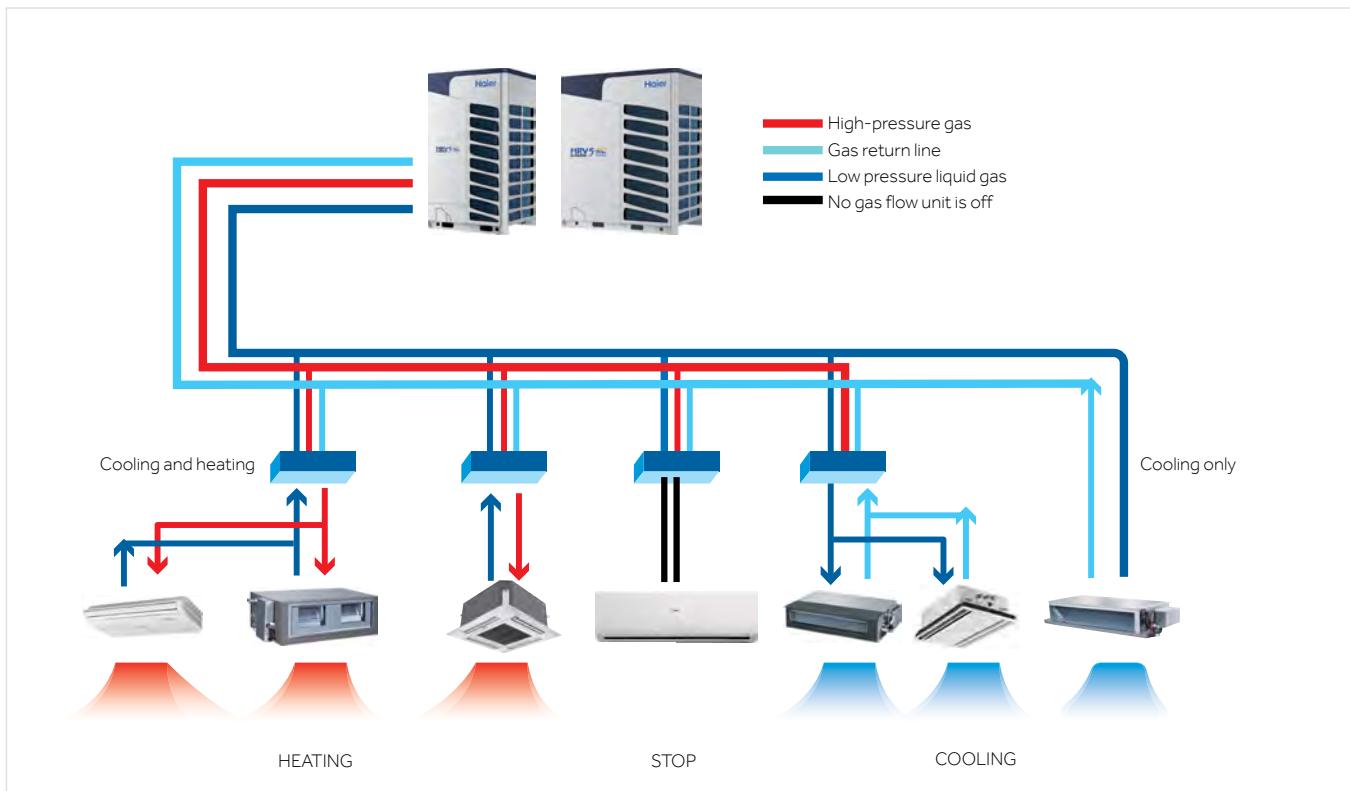

MRV5-RC

DC INVERTER

EXAMPLE OF A 3-PIPE MRV 5-RC SYSTEM

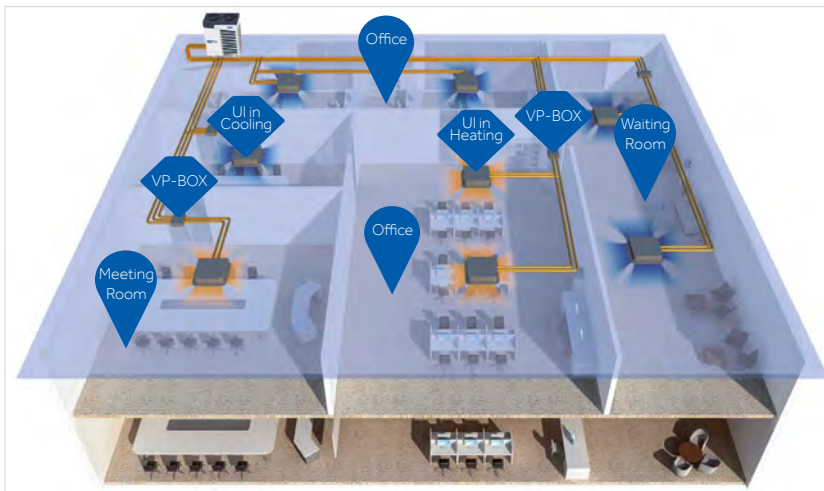

NEW SELECTION VALVES

- Reduced clutter
- Electronic valves for each flow line

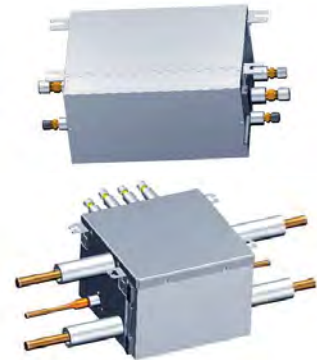

NEW SELECTION VALVES

- Specially designed for MRV 5-RC, volume is small to 0,02m³ (for VP1 box), 0,05m³ (for VP4 box).
- Extensively reduces installation space.
- Individual Valve and Pipe Box for Heat Recovery.
- The valve box can be connected in a series which reduces the use of diverging pipes and reduces the installation cost.

Model*	Maximum connectable capacity (kW)	Power supply	Maximum number of connectable indoor units, same mode of operation	Dimensions (mm)
VP1-112C	$x \leq 11,2$	220-240V single-phase - 50/60Hz	5	388x200x277
VP1-180C	$11,2 < x \leq 18,0$	220-240V single-phase - 50/60Hz	8	388x200x277
VP1-280C	$18,0 < x \leq 28,0$	220-240V single-phase - 50/60Hz	8	388x200x277
VP4-450C	4 ways - max 11,2kW for single output.	220-240V single-phase - 50/60Hz	20	405x300x421

The 4-way box has standard closed output connections. To be opened in case of multiple installations, so that the output of the box becomes the input of the next box. You can connect multiple 4-way boxes in sequence. The input power limit of a series is a maximum of 71 kW.

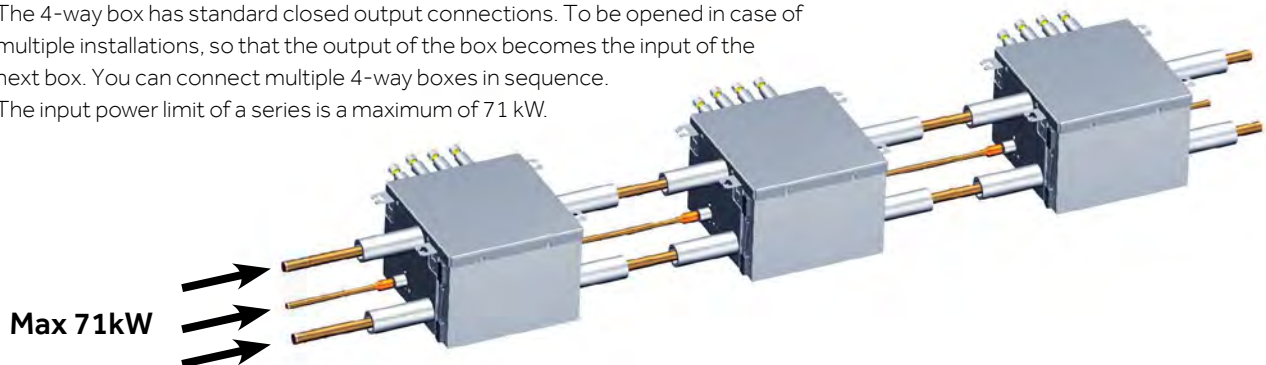

FLEXIBLE INSTALLATION - ability to reverse the orientation of the series in order to have the connections of the indoor units on the right or left or alternating with respect to the main line.

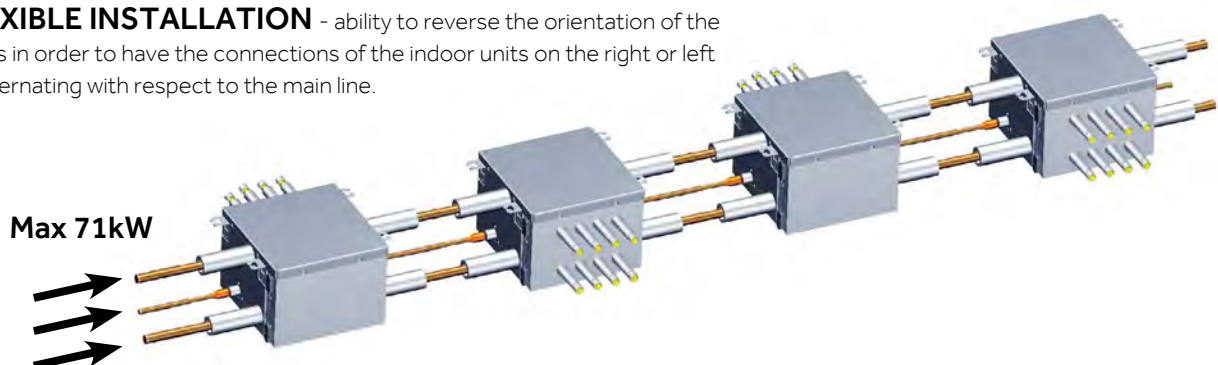

* (limit determined by the diameters of the input pipes of the valve boxes)



8-14HP

AV08IMVURA

AV10IMVURA

AV12IMVURA

AV14IMVURA

Model		AV08IMVURA	AV10IMVURA	AV12IMVURA	AV14IMVURA
Capacity					
Power Class	HP	8	10	12	14
Cooling	kW	22,40	28,00	33,50	40,00
Heating	kW	22,40	28,00	33,50	40,00
Electrical Parameters					
Power supply	Ph-V/Hz	3/380-400/50/60 (5 wires L1+L2+L3+N+T)	3/380-400/50/60 (5 wires L1+L2+L3+N+T)	3/380-400/50/60 (5 wires L1+L2+L3+N+T)	3/380-400/50/60 (5 wires L1+L2+L3+N+T)
Absorbed power - Cooling	kW	5,83	7,67	9,94	12,31
Max absorbed power - Cooling	kW	12,80	13,80	18,20	19,20
Absorbed current in cooling.	A	9,63	12,67	16,43	20,33
Max absorbed current - Cooling	A	21,14	22,79	30,06	31,71
Absorbed power – Heating	kW	5,38	6,67	8,77	10,53
Max absorbed power – Heating	kW	11,50	12,50	17,40	18,40
Absorbed current in heating	A	8,88	11,01	14,48	17,38
Max absorbed current – Heating	A	18,99	20,64	28,74	30,39
EER energy class	W/W	3,84	3,65	3,37	3,25
COP energy class	W/W	4,16	4,20	3,82	3,80
SEER energy class	W/W	6,12	6,68	6,46	6,37
SCOP energy class	W/W	3,82	3,94	3,99	3,86
η _{s,c} %		242	264	255	252
η _{s,h} %		150	155	157	151
Ventilation					
Air flow (High)	m ³ /h	12000	12000	13500	13500
Sound pressure level (High)	dB(A)	57	58	60	61
Sound power level (High)	dB(A)	78	82	88	88
Installation - Dimensions - Components					
Unit Dimensions WxDxH	mm	980x750x1690			
Packaged unit dimensions WxDxH	mm	1070x850x1858			
Net weight / Gross weight	Kg	246/271		257/282	
Compressor type		DC Inverter Scroll	DC Inverter Scroll	DC Inverter Scroll	DC Inverter Scroll
Quantity and type of the compressor	No.	1 INV	1 INV	1 INV	1 INV
Refrigerant type		R410A	R410A	R410A	R410A
Pre-charged refrigerant qty.	Kg	10	10	10	10
Ø Liquid side refrigerant pipe	mm (inch)	9,52 (3/8)	9,52 (3/8)	12,70 (1/2)	12,70 (1/2)
Ø Gas recovery side refrigerant pipe	mm (inch)	19,05 (3/4)	22,22 (7/8)	25,40 (1)	25,40 (1)
Ø High-pressure refrigerant gas pipe	mm (inch)	19,05 (3/4)	19,05 (3/4)	22,22 (7/8)	22,22 (7/8)
Maximum piping length	m	1000	1000	1000	1000
Max linear piping length (Equivalent/Real)	m	260/220	260/220	260/220	260/220
Max. drop between IU and OU (O.U. down/up)*1	m	110/90	110/90	110/90	110/90
Std. drop between IU and OU (O.U. up/down)*2		50/40	50/40	50/40	50/40
Max. drop between IU *3	m	30	30	30	30
Std. drop between IU *4		18	18	18	18
Static Pressure Fans	Pa	110	110	110	110
Connectable Indoor Capacity Ratio					
Indoor / Outdoor Capacity Ratio	%	50 – 130	50 – 130	50 – 130	50 – 130
Maximum number of connectable IUs	No.	13	16	20	24
External Temperature Operating Limits					
Cooling	°C	-5-50	-5-50	-5-50	-5-50
Heating	°C	-23-21	-23-21	-23-21	-23-21

The specifications indicated are obtained with the following test conditions: in Cooling mode, Indoor temperature of 27°C WB / 19°C DB and Outdoor temperature of 35°C WB / 24°C DB. In Heating mode, Indoor temperature of 20°C WB and Outdoor temperature of 7°C WB / 6°C DB

Outdoor Units

MRV5-RC

DC INVERTER



16-22HP

AV16IMVURA
AV18IMVURA
AV20IMVURA
AV22IMVURA

Model		AV16IMVURA	AV18IMVURA	AV20IMVURA	AV22IMVURA
Capacity					
Power Class	HP	16	18	20	22
Cooling	kW	45,00	50,00	56,00	60,00
Heating	kW	45,00	50,00	56,00	60,00
Electrical Parameters					
Power supply	Ph-V/Hz	3/380-400/50/60 (5 wires L1+L2+L3+N+T)	3/380-400/50/60 (5 wires L1+L2+L3+N+T)	3/380-400/50/60 (5 wires L1+L2+L3+N+T)	3/380-400/50/60 (5 wires L1+L2+L3+N+T)
Absorbed power - Cooling	kW	13,93	16,13	17,23	20,00
Max absorbed power - Cooling	kW	25,10	28,50	32,00	33,00
Absorbed current in cooling.	A	23,01	26,64	28,46	33,03
Max absorbed current - Cooling	A	41,45	47,07	52,85	54,50
Absorbed power – Heating	kW	11,39	13,70	15,77	17,91
Max absorbed power – Heating	kW	22,70	25,50	29,40	30,40
Absorbed current in heating	A	18,81	22,62	26,05	29,58
Max absorbed current – Heating	A	37,49	42,11	48,55	50,21
EER energy class	W/W	3,23	3,10	3,25	3,00
COP energy class	W/W	3,95	3,65	3,55	3,35
SEER energy class	W/W	6,86	6,48	5,90	5,63
SCOP energy class	W/W	4,21	3,99	3,93	3,50
ηs,c %		271	256	233	222
ηs,h %		165	157	154	137
Ventilation					
Air flow (High)	m ³ /h	17000	17000	19000	19000
Sound pressure level (High)	dB(A)	62	63	63	64
Sound power level (High)	dB(A)	88	88	88	88
Installation - Dimensions - Components					
Unit Dimensions WxDxH	mm	1410x750x1690			
Packaged unit dimensions WxDxH	mm	1485x850x1858			
Net weight / Gross weight	Kg	366/395		375/404	
Compressor type		DC Inverter Scroll	DC Inverter Scroll	DC Inverter Scroll	DC Inverter Scroll
Quantity and type of the compressor	No.	2 INV	2 INV	2 INV	2 INV
Refrigerant type		R410A	R410A	R410A	R410A
Pre-charged refrigerant qty.	Kg	10	10	10	10
Ø Liquid side refrigerant pipe	mm (inch)	12,70 (1/2)	15,88 (5/8)	15,88 (5/8)	15,88 (5/8)
Ø Gas recovery side refrigerant pipe	mm (inch)	28,58 (1-1/8)	28,58 (1-1/8)	28,58 (1-1/8)	28,58 (1-1/8)
Ø High-pressure refrigerant gas pipe	mm (inch)	25,40 (1)	25,40 (1)	25,40 (1)	25,40 (1)
Maximum piping length	m	1000	1000	1000	1000
Max linear piping length (Equivalent/Real)	m	260/220	260/220	260/220	260/220
Standard height difference between IU and OU	m	110/90	110/90	110/90	110/90
Std. drop between IU and OU (O.U. up/down)*2	m	50/40	50/40	50/40	50/40
Max. drop between IU *3	m	30	30	30	30
Std. drop between IU *4	m	18	18	18	18
Static Pressure Fans	Pa	110	110	110	110
Connectable Indoor Capacity Ratio					
Indoor / Outdoor Capacity Ratio	%	50 – 130	50 – 130	50 – 130	50 – 130
Maximum number of connectable IUs	No.	27	30	33	36
External Temperature Operating Limits					
Cooling	°C	-5~50	-5~50	-5~50	-5~50
Heating	°C	-23~21	-23~21	-23~21	-23~21

The specifications indicated are obtained with the following test conditions: in Cooling mode, Indoor temperature of 27°C WB / 19°C DB and Outdoor temperature of 35°C WB / 24°C DB. In Heating mode, Indoor temperature of 20°C WB and Outdoor temperature of 7°C WB / 6°C DB

The data in this catalogue is purely indicative as the data may vary. Please be advised to check the accuracy of the data with the supplier before purchasing products.



24-30HP

AV12IMVURA

AV14IMVURA

AV16IMVURA

Model		AV24IMVURA AV12IMVURA AV12IMVURA	AV26IMVURA AV12IMVURA AV14IMVURA	AV28IMVURA AV14IMVURA AV14IMVURA	AV30IMVURA AV14IMVURA AV16IMVURA
Capacity					
Power Class	HP	24	26	28	30
Cooling	kW	67,00	73,50	80,00	85,00
Heating	kW	67,00	73,50	80,00	85,00
Electrical Parameters					
Power supply	Ph-V/Hz	3/380-400/50/60 (5 wires L1+L2+L3+N+T)		3/380-400/50/60 (5 wires L1+L2+L3+N+T)	
Absorbed power - Cooling	kW	19,88	22,25	24,62	26,24
Max absorbed power - Cooling	kW	36,40	37,40	38,40	44,30
Absorbed current in cooling	A	32,83	36,74	40,65	43,33
Max absorbed current - Cooling	A	60,11	61,77	63,42	73,16
Absorbed power - Heating	kW	17,54	19,30	21,05	21,92
Max absorbed power - Heating	kW	34,80	35,80	36,80	41,10
Absorbed current in heating	A	28,97	31,87	34,77	36,20
Max absorbed current - Heating	A	57,47	59,12	60,78	67,88
EER energy class	W/W	3,37	3,30	3,25	3,24
COP energy class	W/W	3,82	3,81	3,80	3,88
SEER energy class	W/W	6,46	6,37	6,37	6,37
SCOP energy class	W/W	3,99	3,86	3,86	3,86
η _{s,c} %		255	252	252	252
η _{s,h} %		157	151	151	151
Ventilation					
Air flow (High)	m ³ /h	27000	27000	27000	30500
Sound pressure level (High)	dB(A)	63	64	64	65
Sound power level (High)	dB(A)	88	88	88	88
Installation - Dimensions - Components					
Unit Dimensions WxDxH	mm	980x750x1690+980x750x1690			980x750x1690 + 1410x750x1690
Packaged unit dimensions WxDxH	mm	1070x850x1858+1070x850x1858			1070x850x1858 + 1515x850x1858
Net weight / Gross weight	Kg	246/271+246/271			246/271+366/395
Compressor type		DC Inverter Scroll	DC Inverter Scroll	DC Inverter Scroll	DC Inverter Scroll
Quantity and type of the compressor	No.	2 INV	2 INV	2 INV	3 INV
Refrigerant type		R410A	R410A	R410A	R410A
Pre-charged refrigerant qty.	Kg	20	20	20	20
Ø Liquid side refrigerant pipe	mm (inch)	15,88 (5/8)	15,88 (5/8)	15,88 (5/8)	19,05 (3/4)
Ø Gas recovery side refrigerant pipe	mm (inch)	28,58 (1-1/8)	28,58 (1-1/8)	28,58 (1-1/8)	31,80 (1-1/4)
Ø High-pressure refrigerant gas pipe	mm (inch)	25,40 (1)	25,40 (1)	25,40 (1)	25,40 (1)
Maximum piping length	m	1000	1000	1000	1000
Max linear piping length (Equivalent/Real)	m	260/220	260/220	260/220	260/220
Max. drop between IU and OU (O.U. down/ up)*1	m	110/90	110/90	110/90	110/90
Std. drop between IU and OU (O.U. up/ down)*2	m	50/40	50/40	50/40	50/40
Max. drop between IU *3	m	30	30	30	30
Std. drop between IU *4	m	18	18	18	18
Static Pressure Fans	Pa	110	110	110	110
Connectable Indoor Capacity Ratio					
Indoor / Outdoor Capacity Ratio	%	50 – 130	50 – 130	50 – 130	50 – 130
Maximum number of connectable IUs	No.	40	43	47	50
External Temperature Operating Limits					
Cooling	°C	-5-50	-5-50	-5-50	-5-50
Heating	°C	-23-21	-23-21	-23-21	-23-21

The specifications indicated are obtained with the following test conditions: in Cooling mode, Indoor temperature of 27°C WB / 19°C DB and Outdoor temperature of 35°C WB / 24°C DB. In Heating mode, Indoor temperature of 20°C WB and Outdoor temperature of 7°C WB / 6°C DB

Outdoor Units

MRV5-RC

DC INVERTER



32-40HP

AV16IMVURA

AV18IMVURA

AV20IMVURA

Model		AV32IMVURA AV16IMVURA AV16IMVURA	AV34IMVURA AV16IMVURA AV18IMVURA	AV36IMVURA AV18IMVURA AV18IMVURA	AV38IMVURA AV18IMVURA AV20IMVURA	AV40IMVURA AV20IMVURA AV20IMVURA
Capacity						
Power Class	HP	32	34	36	38	40
Cooling	kW	90,00	95,00	100,00	106,00	112,00
Heating	kW	90,00	95,00	100,00	106,00	112,00
Electrical Parameters						
Power supply	Ph-V/Hz	3/380-400/50/60 (5 wires L1+L2+L3+N+T)	3/380-400/50/60 (5 wires L1+L2+L3+N+T)	3/380-400/50/60 (5 wires L1+L2+L3+N+T)	3/380-400/50/60 (5 wires L1+L2+L3+N+T)	3/380-400/50/60 (5 wires L1+L2+L3+N+T)
Absorbed power - Cooling	kW	27,86	30,06	32,26	33,36	34,46
Max absorbed power - Cooling	kW	50,20	53,60	57,00	60,50	64,00
Absorbed current in cooling.	A	46,02	49,65	53,27	55,09	56,91
Max absorbed current - Cooling	A	82,91	88,52	94,14	99,92	105,70
Absorbed power – Heating	kW	22,78	25,09	27,40	29,47	31,54
Max absorbed power – Heating	kW	45,40	48,20	51,00	54,90	58,80
Absorbed current in heating	A	37,63	41,44	45,25	48,67	52,09
Max absorbed current – Heating	A	74,98	79,60	84,23	90,67	97,11
EER energy class	W/W	3,23	3,16	3,10	3,18	3,25
COP energy class	W/W	3,95	3,79	3,65	3,60	3,55
SEER energy class	W/W	6,86	6,48	6,48	5,90	5,90
SCOP energy class	W/W	4,21	3,99	3,99	3,93	3,93
η _{s,c} %		271	256	256	233	233
η _{s,h} %		165	157	157	154	154
Ventilation						
Air flow (High)	m ³ /h	34000	34000	34000	36000	38000
Sound pressure level (High)	dB(A)	65	66	66	66	66
Sound power level (High)	dB(A)	88	88	88	88	88
Installation - Dimensions - Components						
Unit Dimensions WxDxH	mm	1410x750x1690+1410x750x1690				
Packaged unit dimensions WxDxH	mm	1515x850x1858+1515x850x1858				
Net weight / Gross weight	Kg	366/395 + 366/395			375/404 + 375/404	
Compressor type		DC Inverter Scroll	DC Inverter Scroll	DC Inverter Scroll	DC Inverter Scroll	DC Inverter Scroll
Quantity and type of the compressor	No.	4 INV	4 INV	4 INV	4 INV	4 INV
Refrigerant type		R410A	R410A	R410A	R410A	R410A
Pre-charged refrigerant qty.	Kg	20	20	20	20	20
Ø Liquid side refrigerant pipe	mm (inch)	19,05 (3/4)	19,05 (3/4)	19,05 (3/4)	19,05 (3/4)	19,05 (3/4)
Ø Gas recovery side refrigerant pipe	mm (inch)	31,80 (1-1/4)	31,80 (1-1/4)	38,10 (1-1/2)	38,10 (1-1/2)	38,10 (1-1/2)
Ø High-pressure refrigerant gas pipe	mm (inch)	28,58 (1-1/8)	28,58 (1-1/8)	34,9 (1-3/8)	34,9 (1-3/8)	34,9 (1-3/8)
Maximum piping length	m	1000	1000	1000	1000	1000
Max linear piping length (Equivalent/Real)	m	260/220	260/220	260/220	260/220	260/220
Max. drop between IU and OU (O.U. down/ up)*1	m	110/90	110/90	110/90	110/90	110/90
Std. drop between IU and OU (O.U. up/ down)*2	m	50/40	50/40	50/40	50/40	50/40
Max. drop between IU *3	m	30	30	30	30	30
Std. drop between IU *4	m	18	18	18	18	18
Static Pressure Fans	Pa	110	110	110	110	110
Connectable Indoor Capacity Ratio						
Indoor / Outdoor Capacity Ratio	%	50 – 130	50 – 130	50 – 130	50 – 130	50 – 130
Maximum number of connectable IUs	No.	53	56	59	63	64
External Temperature Operating Limits						
Cooling	°C	-5-50	-5-50	-5-50	-5-50	-5-50
Heating	°C	-23-21	-23-21	-23-21	-23-21	-23-21

The specifications indicated are obtained with the following test conditions: in Cooling mode, Indoor temperature of 27°C WB / 19°C DB and Outdoor temperature of 35°C WB / 24°C DB. In Heating mode, Indoor temperature of 20°C WB and Outdoor temperature of 7°C WB / 6°C DB



42-46HP

AV14IMVURA

AV16IMVURA

AV20IMVURA

AV22IMVURA

Model		AV42IMVURA AV20IMVURA AV22IMVURA	AV44IMVURA AV22IMVURA AV22IMVURA	AV46IMVURA AV14IMVURA AV16IMVURA AV16IMVURA
Capacity				
Power Class	HP	42	44	46
Cooling	kW	116,00	120,00	130,00
Heating	kW	116,00	120,00	130,00
Electrical Parameters				
Power supply	Ph-V/Hz	3/380-400/50/60 (5 wires L1+L2+L3+N+T)	3/380-400/50/60 (5 wires L1+L2+L3+N+T)	3/380-400/50/60 (5 wires L1+L2+L3+N+T)
Absorbed power - Cooling	kW	37,23	40,00	40,17
Max absorbed power - Cooling	kW	65,00	66,00	69,40
Absorbed current in cooling.	A	61,49	66,06	66,34
Max absorbed current - Cooling	A	107,35	109,00	114,61
Absorbed power - Heating	kW	33,69	35,82	33,31
Max absorbed power - Heating	kW	59,80	60,80	63,80
Absorbed current in heating	A	55,62	59,16	55,01
Max absorbed current - Heating	A	98,76	100,41	105,37
EER energy class	W/W	3,12	3,00	3,24
COP energy class	W/W	3,44	3,35	3,90
SEER energy class	W/W	5,63	5,63	6,37
SCOP energy class	W/W	3,50	3,50	3,86
η _{s,c} %		222	222	252
η _{s,h} %		137	137	151
Ventilation				
Air flow (High)	m ³ /h	38000	38000	47500
Sound pressure level (High)	dB(A)	67	67	67
Sound power level (High)	dB(A)	88	88	88
Installation - Dimensions - Components				
Unit Dimensions WxDxH	mm	1410x750x1690 + 1410x750x1690		980x750x1690 + 1410x750x1690 + 1410x750x1690
Packaged unit dimensions WxDxH	mm	1515x850x1858 + 1515x850x1858		1070x850x1838 + 1515x850x1838 + 1515x850x1838
Net weight / Gross weight	Kg	375/404 + 375/404		257/282 + 366/395 + 366/395
Compressor type		DC Inverter Scroll	DC Inverter Scroll	DC Inverter Scroll
Quantity and type of the compressor	No.	4 INV	4 INV	5 INV
Refrigerant type		R410A	R410A	R410A
Pre-charged refrigerant qty.	Kg	20	20	30
Ø Liquid side refrigerant pipe	mm (inch)	19,05 (3/4)	19,05 (3/4)	19,05 (3/4)
Ø Gas recovery side refrigerant pipe	mm (inch)	38,10 (1-1/2)	38,10 (1-1/2)	38,10 (1-1/2)
Ø High-pressure refrigerant gas pipe	mm (inch)	34,9 (1-3/8)	34,9 (1-3/8)	34,9 (1-3/8)
Maximum piping length	m	1000	1000	1000
Max linear piping length (Equivalent/Real)	m	260/220	260/220	260/220
Max. drop between IU and OU (O.U. down/up)*1	m	110/90	110/90	110/90
Std. drop between IU and OU (O.U. up/down)*2		50/40	50/40	50/40
Max. drop between IU *3	m	30	30	30
Std. drop between IU *4		18	18	18
Static Pressure Fans	Pa	110	110	110
Connectable Indoor Capacity Ratio				
Indoor / Outdoor Capacity Ratio	%	50 – 130	50 – 130	50 – 130
Maximum number of connectable IUs	No.	64	64	64
External Temperature Operating Limits				
Cooling	°C	-5-50	-5-50	-5-50
Heating	°C	-23-21	-23-21	-23-21

The specifications indicated are obtained with the following test conditions: in Cooling mode, Indoor temperature of 27°C WB / 19°C DB and Outdoor temperature of 35°C WB / 24°C DB. In Heating mode, Indoor temperature of 20°C WB and Outdoor temperature of 7°C WB / 6°C DB

Outdoor Units

MRV5-RC

DC INVERTER



48-56HP

AV16IMVURA

AV18IMVURA

AV20IMVURA

Model		AV48IMVURA AV16IMVURA AV16IMVURA AV16IMVURA	AV50IMVURA AV16IMVURA AV16IMVURA AV18IMVURA	AV52IMVURA AV16IMVURA AV18IMVURA AV18IMVURA	AV54IMVURA AV18IMVURA AV18IMVURA AV18IMVURA	AV56IMVURA AV18IMVURA AV18IMVURA AV20IMVURA
Capacity						
Power Class	HP	48	50	52	54	56
Cooling	kW	135,00	140,00	145,00	150,00	156,00
Heating	kW	135,00	140,00	145,00	150,00	156,00
Electrical Parameters						
Power supply	Ph-V/Hz	3/380-400/50/60 (5 wires L1+L2+L3+N+T)	3/380-400/50/60 (5 wires L1+L2+L3+N+T)	3/380-400/50/60 (5 wires L1+L2+L3+N+T)	3/380-400/50/60 (5 wires L1+L2+L3+N+T)	3/380-400/50/60 (5 wires L1+L2+L3+N+T)
Absorbed power - Cooling	kW	41,80	43,99	46,19	48,39	49,49
Max absorbed power - Cooling	kW	75,30	78,70	82,10	85,50	89,00
Absorbed current in cooling.	A	69,03	72,65	76,28	79,91	81,73
Max absorbed current - Cooling	A	124,36	129,97	135,59	141,20	146,98
Absorbed power - Heating	kW	34,18	36,48	38,79	41,10	43,17
Max absorbed power - Heating	kW	68,10	70,90	73,70	76,50	80,40
Absorbed current in heating	A	56,44	60,25	64,06	67,87	71,29
Max absorbed current - Heating	A	112,47	117,09	121,72	126,34	132,78
EER energy class	W/W	3,23	3,18	3,14	3,10	3,15
COP energy class	W/W	3,95	3,84	3,74	3,65	3,61
SEER energy class	W/W	6,86	6,48	6,48	6,48	5,50
SCOP energy class	W/W	4,21	3,99	3,99	3,99	3,93
η _{s,c} %		271	256	256	256	233
η _{s,h} %		165	157	157	157	154
Ventilation						
Air flow (High)	m ³ /h	51000	51000	51000	51000	53000
Sound pressure level (High)	dB(A)	67	67	68	68	68
Sound power level (High)	dB(A)	88	88	88.5	89	89
Installation - Dimensions - Components						
Unit Dimensions WxDxH	mm	1410x750x1690+1410x750x1690+1410x750x1690				
Packaged unit dimensions WxDxH	mm	1485x850x1858+1485x850x1858+1485x850x1858				
Net weight / Gross weight	Kg	366/395+366/395+366/395				366/395 + 366/395 + 375/404
Compressor type		DC Inverter Scroll	DC Inverter Scroll	DC Inverter Scroll	DC Inverter Scroll	DC Inverter Scroll
Quantity and type of the compressor	No.	6 INV	6 INV	6 INV	6 INV	6 INV
Refrigerant type		R410A	R410A	R410A	R410A	R410A
Pre-charged refrigerant qty.	Kg	30	30	30	30	30
Ø Liquid side refrigerant pipe	mm (inch)	19,05 (3/4)	19,05 (3/4)	19,05 (3/4)	19,05 (3/4)	19,05 (3/4)
Ø Gas recovery side refrigerant pipe	mm (inch)	38,10 (1-1/2)	38,10 (1-1/2)	38,10 (1-1/2)	38,10 (1-1/2)	38,10 (1-1/2)
Ø High-pressure refrigerant gas pipe	mm (inch)	34,9 (1-3/8)	34,9 (1-3/8)	34,9 (1-3/8)	34,9 (1-3/8)	34,9 (1-3/8)
Maximum piping length	m	1000	1000	1000	1000	1000
Max linear piping length (Equivalent/Real)	m	260/220	260/220	260/220	260/220	260/220
Max. drop between IU and OU (O.U. down/up)*1	m	110/90	110/90	110/90	110/90	110/90
Std. drop between IU and OU (O.U. up/down)*2	m	50/40	50/40	50/40	50/40	50/40
Max. drop between IU *3	m	30	30	30	30	30
Std. drop between IU *4	m	18	18	18	18	18
Static Pressure Fans	Pa	110	110	110	110	110
Connectable Indoor Capacity Ratio						
Indoor / Outdoor Capacity Ratio	%	50 - 130	50 - 130	50 - 130	50 - 130	50 - 130
Maximum number of connectable IUs	No.	64	64	64	64	64
External Temperature Operating Limits						
Cooling	°C	-5-50	-5-50	-5-50	-5-50	-5-50
Heating	°C	-23-21	-23-21	-23-21	-23-21	-23-21

The specifications indicated are obtained with the following test conditions: in Cooling mode, Indoor temperature of 27°C WB / 19°C DB and Outdoor temperature of 35°C WB / 24°C DB. In Heating mode, Indoor temperature of 20°C WB and Outdoor temperature of 7°C WB / 6°C DB



58-66HP

AV18IMVURA

AV20IMVURA

AV22IMVURA

Model		AV58IMVURA AV18IMVURA AV20IMVURA AV20IMVURA	AV60IMVURA AV20IMVURA AV20IMVURA AV20IMVURA	AV62IMVURA AV20IMVURA AV20IMVURA AV22IMVURA	AV64IMVURA AV20IMVURA AV22IMVURA AV22IMVURA	AV66IMVURA AV22IMVURA AV22IMVURA AV22IMVURA
Capacity						
Power Class	HP	58	60	62	64	66
Cooling	kW	162,00	168,0	172,00	176,00	180,00
Heating	kW	162,00	168,00	172,00	176,00	180,00
Electrical Parameters						
Power supply	Ph-V/Hz	3/380-400/50/60 (5 wires L1+L2+L3+N+T)	3/380-400/50/60 (5 wires L1+L2+L3+N+T)	3/380-400/50/60 (5 wires L1+L2+L3+N+T)	3/380-400/50/60 (5 wires L1+L2+L3+N+T)	3/380-400/50/60 (5 wires L1+L2+L3+N+T)
Absorbed power - Cooling	kW	50,59	51,69	54,46	57,23	6,00
Max absorbed power - Cooling	kW	92,50	96,00	97,00	98,00	99,00
Absorbed current in cooling.	A	83,55	85,37	89,94	94,52	99,09
Max absorbed current - Cooling	A	152,76	158,54	160,20	161,85	163,50
Absorbed power - Heating	kW	45,25	47,31	49,45	51,59	53,73
Max absorbed power - Heating	kW	84,30	88,20	89,20	90,20	91,20
Absorbed current in heating	A	74,71	78,13	81,67	85,20	88,74
Max absorbed current - Heating	A	139,22	145,66	147,31	148,97	150,62
EER energy class	W/W	3,20	3,25	3,16	3,08	3,00
COP energy class	W/W	3,58	3,55	3,48	3,41	3,35
SEER energy class	W/W	5,90	5,90	5,63	5,63	5,63
SCOP energy class	W/W	3,93	3,93	3,50	3,50	3,50
ηs,c %		233	233	222	222	222
ηs,h %		154	154	137	137	137
Ventilation						
Air flow (High)	m³/h	55000	57000	57000	57000	57000
Sound pressure level (High)	dB(A)	68	68	68	69	69
Sound power level (High)	dB(A)	89	89	89	90	90
Installation - Dimensions - Components						
Unit Dimensions WxDxH	mm	1410x750x1690+1410x750x1690+1410x750x1690				
Packaged unit dimensions WxDxH	mm	1485x850x1858+1485x850x1858+1485x850x1858				
Net weight / Gross weight	Kg	366/395 + 375/404 + 375/404	375/404 + 375/404 + 375/404			
Compressor type		DC Inverter Scroll	DC Inverter Scroll	DC Inverter Scroll	DC Inverter Scroll	DC Inverter Scroll
Quantity and type of the compressor	No.	6 INV	6 INV	6 INV	6 INV	6 INV
Refrigerant type		R410A	R410A	R410A	R410A	R410A
Pre-charged refrigerant qty.	Kg	30	30	30	30	30
Ø Liquid side refrigerant pipe	mm (inch)	19,05 (3/4)	19,05 (3/4)	19,05 (3/4)	19,05 (3/4)	19,05 (3/4)
Ø Gas recovery side refrigerant pipe	mm (inch)	41,30 (1-5/8)	41,30 (1-5/8)	41,30 (1-5/8)	41,30 (1-5/8)	41,30 (1-5/8)
Ø High-pressure refrigerant gas pipe	mm (inch)	38,10 (1-1/2)	38,10 (1-1/2)	38,10 (1-1/2)	38,10 (1-1/2)	38,10 (1-1/2)
Maximum piping length	m	1000	1000	1000	1000	1000
Max linear piping length (Equivalent/Real)	m	260/220	260/220	260/220	260/220	260/220
Max. drop between IU and OU (O.U. down/up)*1	m	110/90	110/90	110/90	110/90	110/90
Std. drop between IU and OU (O.U. up/down)*2	m	50/40	50/40	50/40	50/40	50/40
Max. drop between IU *3	m	30	30	30	30	30
Std. drop between IU *4	m	18	18	18	18	18
Static Pressure Fans	Pa	110	110	110	110	110
Connectable Indoor Capacity Ratio						
Indoor / Outdoor Capacity Ratio	%	50 – 130	50 – 130	50 – 130	50 – 130	50 – 130
Maximum number of connectable IUs	No.	64	64	64	64	64
External Temperature Operating Limits						
Cooling	°C	-5-50	-5-50	-5-50	-5-50	-5-50
Heating	°C	-23-21	-23-21	-23-21	-23-21	-23-21

The specifications indicated are obtained with the following test conditions: in Cooling mode, Indoor temperature of 27°C WB / 19°C DB and Outdoor temperature of 35°C WB / 24°C DB. In Heating mode, Indoor temperature of 20°C WB and Outdoor temperature of 7°C WB / 6°C DB

Outdoor Units

MRV5-RC

DC INVERTER



68-74HP

AV16IMVURA

AV18IMVURA

AV20IMVURA

Model		AV68IMVURA AV16IMVURA AV16IMVURA AV18IMVURA AV18IMVURA	AV70IMVURA AV16IMVURA AV18IMVURA AV18IMVURA AV18IMVURA	AV72IMVURA AV18IMVURA AV18IMVURA AV18IMVURA AV18IMVURA	AV74IMVURA AV18IMVURA AV18IMVURA AV18IMVURA AV20IMVURA
Capacity					
Power Class	HP	68	70	72	74
Cooling	kW	190,00	195,00	200,00	206,00
Heating	kW	190,00	195,00	200,00	206,00
Electrical Parameters					
Power supply	Ph-V/Hz	3/380-400/50/60 (5 wires L1+L2+L3+N+T)		3/380-400/50/60 (5 wires L1+L2+L3+N+T)	
Absorbed power - Cooling	kW	60,12	62,32	64,52	65,62
Max absorbed power - Cooling	kW	107,20	110,60	114,00	117,50
Absorbed current in cooling.	A	99,29	102,92	106,55	108,37
Max absorbed current - Cooling	A	177,04	182,66	188,27	194,05
Absorbed power – Heating	kW	50,18	52,49	54,79	56,87
Max absorbed power – Heating	kW	96,40	99,20	102,00	105,90
Absorbed current in heating	A	82,88	86,68	90,49	93,91
Max absorbed current – Heating	A	159,21	163,83	168,45	174,89
EER energy class	W/W	3,16	3,13	3,10	3,14
COP energy class	W/W	3,79	3,72	3,65	3,62
SEER energy class	W/W	6,48	6,48	6,48	5,90
SCOP energy class	W/W	3,99	3,99	3,99	3,93
η _{s,c} %		256	256	256	233
η _{s,h} %		157	157	157	154
Ventilation					
Air flow (High)	m ³ /h	68000	68000	68000	70000
Sound pressure level (High)	dB(A)	69	69	69	69
Sound power level (High)	dB(A)	90	90	90	90
Installation - Dimensions - Components					
Unit Dimensions WxDxH	mm	1410x750x1690+1410x750x1690+1410x750x1690+1410x750x1690			
Packaged unit dimensions WxDxH	mm	1515x850x1858+1515x850x1858+1515x850x1858+1515x850x1858			
Net weight / Gross weight	Kg	366/395+366/395+366/395+366/395			366/395 + 366/395 + 375/404
Compressor type		DC Inverter Scroll	DC Inverter Scroll	DC Inverter Scroll	DC Inverter Scroll
Quantity and type of the compressor	No.	8 INV	8 INV	8 INV	8 INV
Refrigerant type		R410A	R410A	R410A	R410A
Pre-charged refrigerant qty.	Kg	40	40	40	40
Ø Liquid side refrigerant pipe	mm (inch)	22,20 (7/8)	22,20 (7/8)	22,20 (7/8)	22,20 (7/8)
Ø Gas recovery side refrigerant pipe	mm (inch)	44,50 (1-3/4)	44,50 (1-3/4)	44,50 (1-3/4)	44,50 (1-3/4)
Ø High-pressure refrigerant gas pipe	mm (inch)	41,30 (1-5/8)	41,30 (1-5/8)	41,30 (1-5/8)	41,30 (1-5/8)
Maximum piping length	m	1000	1000	1000	1000
Max linear piping length (Equivalent/Real)	m	260/220	260/220	260/220	260/220
Max. drop between IU and OU (O.U. down/up)*1	m	110/90	110/90	110/90	110/90
Std. drop between IU and OU (O.U. up/down)*2		50/40	50/40	50/40	50/40
Max. drop between IU *3	m	30	30	30	30
Std. drop between IU *4		18	18	18	18
Static Pressure Fans	Pa	110	110	110	110
Connectable Indoor Capacity Ratio					
Indoor / Outdoor Capacity Ratio	%	50 – 130	50 – 130	50 – 130	50 – 130
Maximum number of connectable IUs	No.	64	64	64	64
External Temperature Operating Limits					
Cooling	°C	-5-50	-5-50	-5-50	-5-50
Heating	°C	-23-21	-23-21	-23-21	-23-21

The specifications indicated are obtained with the following test conditions: in Cooling mode, Indoor temperature of 27°C WB / 19°C DB and Outdoor temperature of 35°C WB / 24°C DB. In Heating mode, Indoor temperature of 20°C WB and Outdoor temperature of 7°C WB / 6°C DB



76-82HP

AV18IMVURA

AV20IMVURA

AV22IMVURA

Model		AV76IMVURA AV18IMVURA AV18IMVURA AV20IMVURA AV20IMVURA	AV78IMVURA AV18IMVURA AV20IMVURA AV20IMVURA AV20IMVURA	AV80IMVURA AV20IMVURA AV20IMVURA AV20IMVURA AV20IMVURA	AV82IMVURA AV20IMVURA AV20IMVURA AV20IMVURA AV22IMVURA
Capacity					
Power Class	HP	76	78	80	82
Cooling	kW	212,00	218,00	224,00	228,00
Heating	kW	212,00	218,00	224,00	228,00
Electrical Parameters					
Power supply	Ph-V/Hz	3/380-400/50/60 (5 wires L1+L2+L3+N+T)	3/380-400/50/60 (5 wires L1+L2+L3+N+T)	3/380-400/50/60 (5 wires L1+L2+L3+N+T)	3/380-400/50/60 (5 wires L1+L2+L3+N+T)
Absorbed power - Cooling	kW	66,72	67,82	68,92	71,69
Max absorbed power - Cooling	kW	121,00	124,50	128,00	129,00
Absorbed current in cooling.	A	110,19	112,01	113,83	118,40
Max absorbed current - Cooling	A	199,83	205,61	211,39	213,04
Absorbed power - Heating	kW	58,94	61,01	63,08	65,22
Max absorbed power - Heating	kW	109,80	113,70	117,60	118,60
Absorbed current in heating	A	97,34	100,76	104,18	107,71
Max absorbed current - Heating	A	181,34	187,78	194,22	195,87
EER energy class	W/W	3,18	3,21	3,25	3,18
COP energy class	W/W	3,60	3,57	3,55	3,50
SEER energy class	W/W	5,90	5,90	5,90	5,63
SCOP energy class	W/W	3,93	3,93	3,93	3,50
η _{s,c} %		233	233	233	222
η _{s,h} %		154	154	154	137
Ventilation					
Air flow (High)	m ³ /h	72000	74000	76000	76000
Sound pressure level (High)	dB(A)	69	69	69	69
Sound power level (High)	dB(A)	90	90	90	90
Installation - Dimensions - Components					
Unit Dimensions WxDxH	mm	1410x750x1690+1410x750x1690+1410x750x1690+1410x750x1690			
Packaged unit dimensions WxDxH	mm	1515x850x1858+1515x850x1858+1515x850x1858+1515x850x1858			
Net weight / Gross weight	Kg	366/395 + 366/395 + 375/404 + 375/404	366/395 + 375/404 + 375/404 + 375/404	375/404+375/404+375/404+375/404	
Compressor type		DC Inverter Scroll	DC Inverter Scroll	DC Inverter Scroll	DC Inverter Scroll
Quantity and type of the compressor	No.	8 INV	8 INV	8 INV	8 INV
Refrigerant type		R410A	R410A	R410A	R410A
Pre-charged refrigerant qty.	Kg	40	40	40	40
Ø Liquid side refrigerant pipe	mm (inch)	22,20 (7/8)	22,20 (7/8)	22,20 (7/8)	22,20 (7/8)
Ø Gas recovery side refrigerant pipe	mm (inch)	44,50 (1-3/4)	44,50 (1-3/4)	44,50 (1-3/4)	44,50 (1-3/4)
Ø High-pressure refrigerant gas pipe	mm (inch)	41,30 (1-5/8)	41,30 (1-5/8)	41,30 (1-5/8)	41,30 (1-5/8)
Maximum piping length	m	1000	1000	1000	1000
Max linear piping length (Equivalent/Real)	m	260/220	260/220	260/220	260/220
Max. drop between IU and OU (O.U. down/up)*1	m	110/90	110/90	110/90	110/90
Std. drop between IU and OU (O.U. up/down)*2	m	50/40	50/40	50/40	50/40
Max. drop between IU *3	m	30	30	30	30
Std. drop between IU *4	m	18	18	18	18
Static Pressure Fans	Pa	110	110	110	110
Connectable Indoor Capacity Ratio					
Indoor / Outdoor Capacity Ratio	%	50 - 130	50 - 130	50 - 130	50 - 130
Maximum number of connectable IUs	No.	64	64	64	64
External Temperature Operating Limits					
Cooling	°C	-5-50	-5-50	-5-50	-5-50
Heating	°C	-23-21	-23-21	-23-21	-23-21

The specifications indicated are obtained with the following test conditions: in Cooling mode, Indoor temperature of 27°C WB / 19°C DB and Outdoor temperature of 35°C WB / 24°C DB. In Heating mode, Indoor temperature of 20°C WB and Outdoor temperature of 7°C WB / 6°C DB

Outdoor Units

MRV5-RC

DC INVERTER



84-88HP

AV20IMVURA

AV22IMVURA

Model		AV84IMVURA AV20IMVURA AV20IMVURA AV22IMVURA AV22IMVURA	AV86IMVURA AV20IMVURA AV22IMVURA AV22IMVURA AV22IMVURA	AV88IMVURA AV22IMVURA AV22IMVURA AV22IMVURA AV22IMVURA
Capacity				
Power Class	HP	84	86	88
Cooling	kW	232,00	236,00	240,00
Heating	kW	232,00	236,00	240,00
Electrical Parameters				
Power supply	Ph-V/Hz	3/380-400/50/60 (5 wires L1+L2+L3+N+T)	3/380-400/50/60 (5 wires L1+L2+L3+N+T)	3/380-400/50/60 (5 wires L1+L2+L3+N+T)
Absorbed power - Cooling	kW	74,46	77,23	80,00
Max absorbed power - Cooling	kW	130,00	131,00	132,00
Absorbed current in cooling.	A	122,97	127,55	132,12
Max absorbed current - Cooling	A	214,70	216,35	218,00
Absorbed power – Heating	kW	67,36	69,50	71,64
Max absorbed power – Heating	kW	119,60	120,60	121,60
Absorbed current in heating	A	111,25	114,78	118,31
Max absorbed current – Heating	A	197,52	199,17	200,82
EER energy class	W/W	3,12	3,06	3,00
COP energy class	W/W	3,44	3,40	3,35
SEER energy class	W/W	5,63	5,63	5,63
SCOP energy class	W/W	3,50	3,50	3,50
$\eta_{s,c}$ %		222	222	222
$\eta_{s,h}$ %		137	137	137
Ventilation				
Air flow (High)	m ³ /h	76000	76000	76000
Sound pressure level (High)	dB(A)	70	70	70
Sound power level (High)	dB(A)	91	91	91
Installation - Dimensions - Components				
Unit Dimensions WxDxH	mm	1410x750x1690+1410x750x1690+1410x750x1690+1410x750x1690		
Packaged unit dimensions WxDxH	mm	1515x850x1858+1515x850x1858+1515x850x1858+1515x850x1858		
Net weight / Gross weight	Kg	375/404+375/404+375/404+375/404		
Compressor type		DC Inverter Scroll	DC Inverter Scroll	DC Inverter Scroll
Quantity and type of the compressor	No.	8 INV	8 INV	8 INV
Refrigerant type		R410A	R410A	R410A
Pre-charged refrigerant qty.	Kg	40	40	40
Ø Liquid side refrigerant pipe	mm (inch)	22,20 (7/8)	25,40 (1)	25,40 (1)
Ø Gas recovery side refrigerant pipe	mm (inch)	44,50 (1-3/4)	50,80 (2)	50,80 (2)
Ø High-pressure refrigerant gas pipe	mm (inch)	41,30 (1-5/8)	44,50 (1-3/4)	44,50 (1-3/4)
Maximum piping length	m	1000	1000	1000
Max linear piping length (Equivalent/Real)	m	260/220	260/220	260/220
Max. drop between IU and OU (O.U. down/up)*1	m	110/90	110/90	110/90
Std. drop between IU and OU (O.U. up/down)*2	m	50/40	50/40	50/40
Max. drop between IU *3	m	30	30	30
Std. drop between IU *4	m	18	18	18
Static Pressure Fans	Pa	110	110	110
Connectable Indoor Capacity Ratio				
Indoor / Outdoor Capacity Ratio	%	50 – 130	50 – 130	50 – 130
Maximum number of connectable IUs	No.	64	64	64
External Temperature Operating Limits				
Cooling	°C	-5-50	-5-50	-5-50
Heating	°C	-23-21	-23-21	-23-21

The specifications indicated are obtained with the following test conditions: in Cooling mode, Indoor temperature of 27°C WB / 19°C DB and Outdoor temperature of 35°C WB / 24°C DB. In Heating mode, Indoor temperature of 20°C WB and Outdoor temperature of 7°C WB / 6°C DB

The data in this catalogue is purely indicative as the data may vary. Please be advised to check the accuracy of the data with the supplier before purchasing products.

MRV OUTDOOR UNITS

AV08IM**A AV10IM**A AV12IM**A AV14IM**A AV16IM**A

Unit:mm

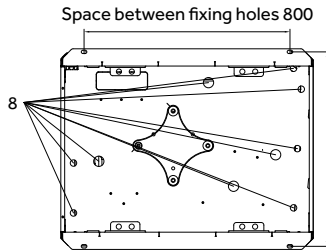

Space between fixing holes 755

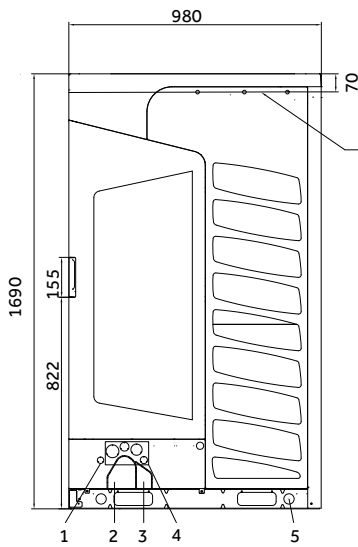
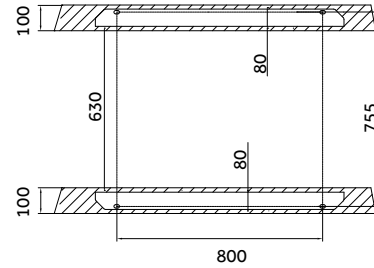

Air outlet duct connection position

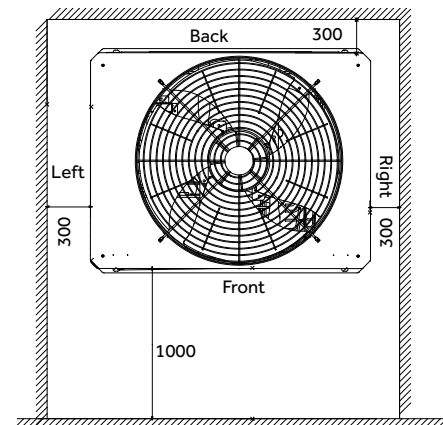
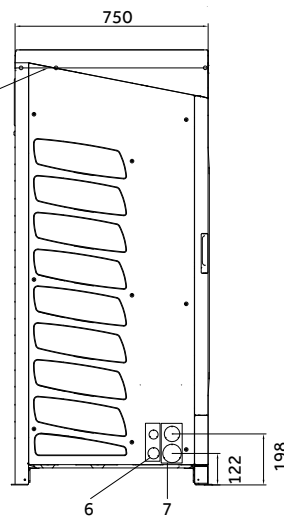

(*1) 50 m when the outdoor unit is above the indoor unit / 40 m when it is below

The specifications indicated are obtained with the following test conditions: in Cooling mode, Indoor temperature of 27°C WB / 19°C DB and Outdoor temperature of 35°C WB / 24°C DB. In Heating mode, Indoor temperature of 20°C WB and Outdoor temperature of 7°C WB / 6°C DB

Outdoor Units

MRV5-RC

DC INVERTER

MRV OUTDOOR UNITS

AV18IM**A AV20IM**A AV22IM**A AV24IM**A AV26IM**A

Unit:mm

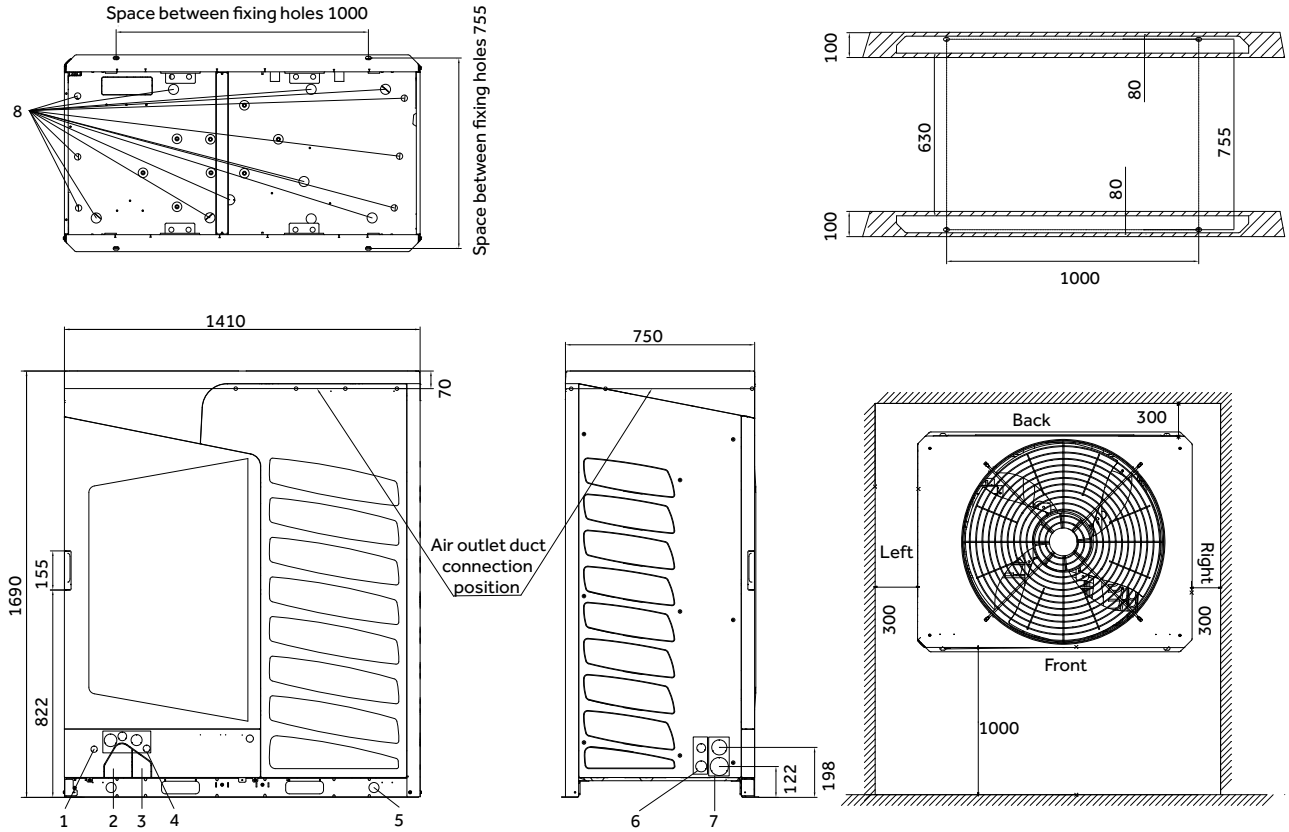

(*1) 50 m when the outdoor unit is above the indoor unit / 40 m when it is below

The specifications indicated are obtained with the following test conditions: in Cooling mode, Indoor temperature of 27°C WB / 19°C DB and Outdoor temperature of 35°C WB / 24°C DB. In Heating mode, Indoor temperature of 20°C WB and Outdoor temperature of 7°C WB / 6°C DB

The data in this catalogue is purely indicative as the data may vary. Please be advised to check the accuracy of the data with the supplier before purchasing products.



MRV W

Heat Pump
System Full DC
Inverter Water
Cooled

MRV-W - FEATURES

OPERATING PRINCIPLE

MRV-W are MRV/VRF systems with direct refrigerant expansion and inverter compressors that use the same indoor units as the classic MRV systems, controls and joints.

The design and implementation of the internal circuit follows the same rules as a normal MRV/VRF system, the only difference is that they use water and not air to condense or evaporate on the outdoor unit. MRV-W therefore does not have fans and large air/refrigerant exchangers but uses special water/refrigerant exchangers. This allows to significantly reduce the size of the product compared to a classic MRV of equal cooling capacity.

Thanks to its small footprint, of only W 775 x D 545 x H 995, the installation of the MRV-W takes place inside technical rooms, basements, garages and corridors as it does not need to exchange energy with the outdoor air.

The water needed for operation reaches the units through small diameter pipes. Water can have different origins such as ground water, lake, sea, river, end industrial processes, accumulation of non-drinking water.

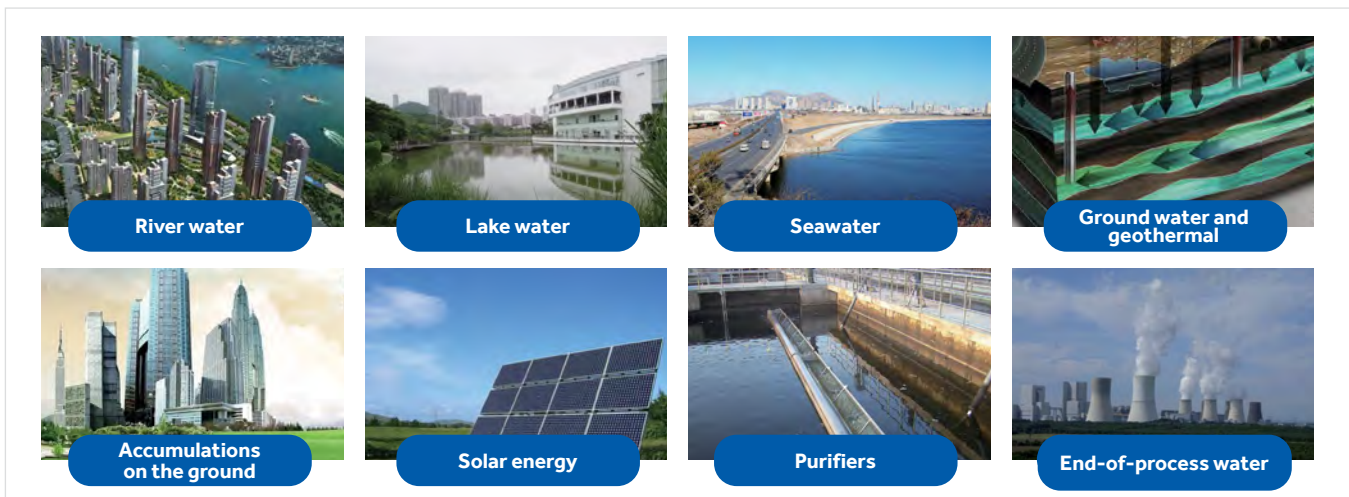
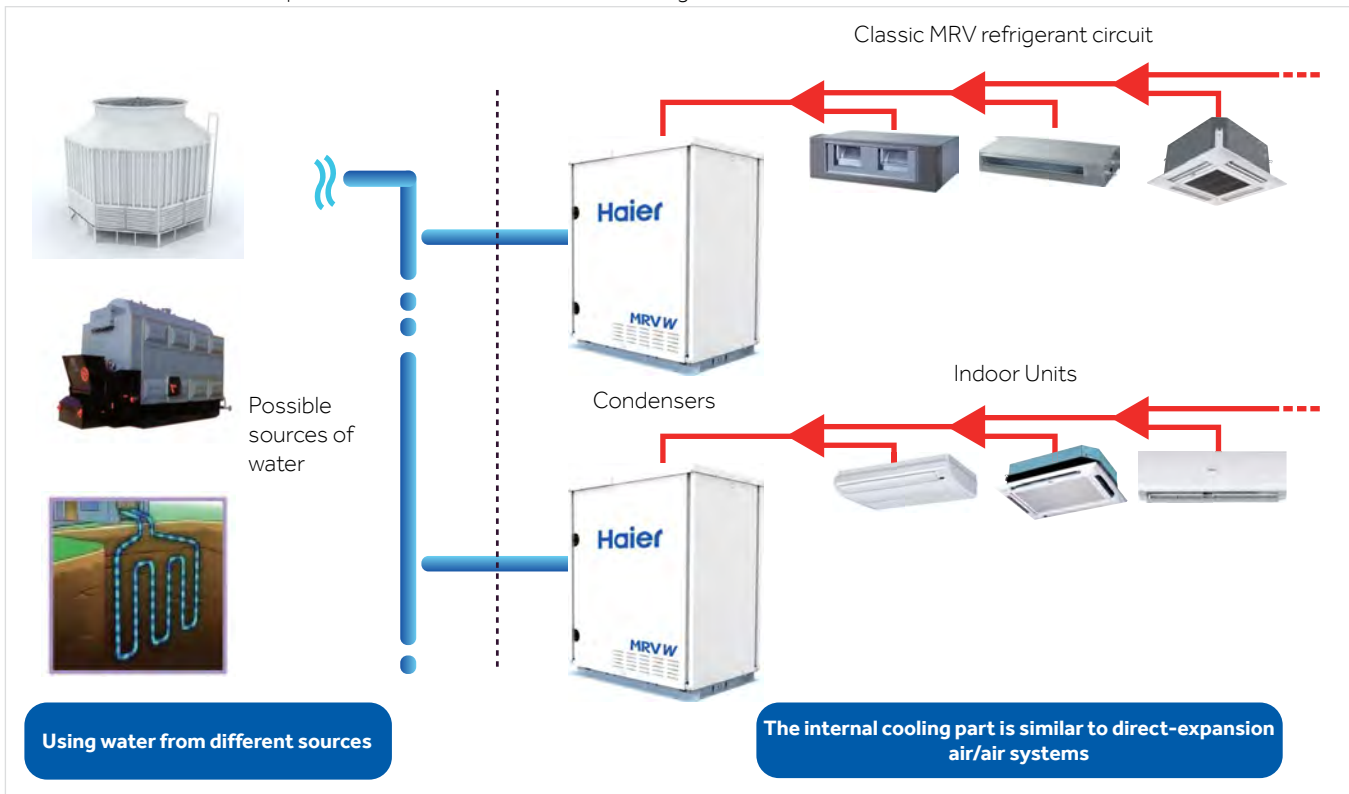

CONFIGURATION

MRV-W is a direct expansion system that combines the efficiency of the VRF technology with the use of water from a variety of sources.



EXAMPLE OF COOLING OPERATION

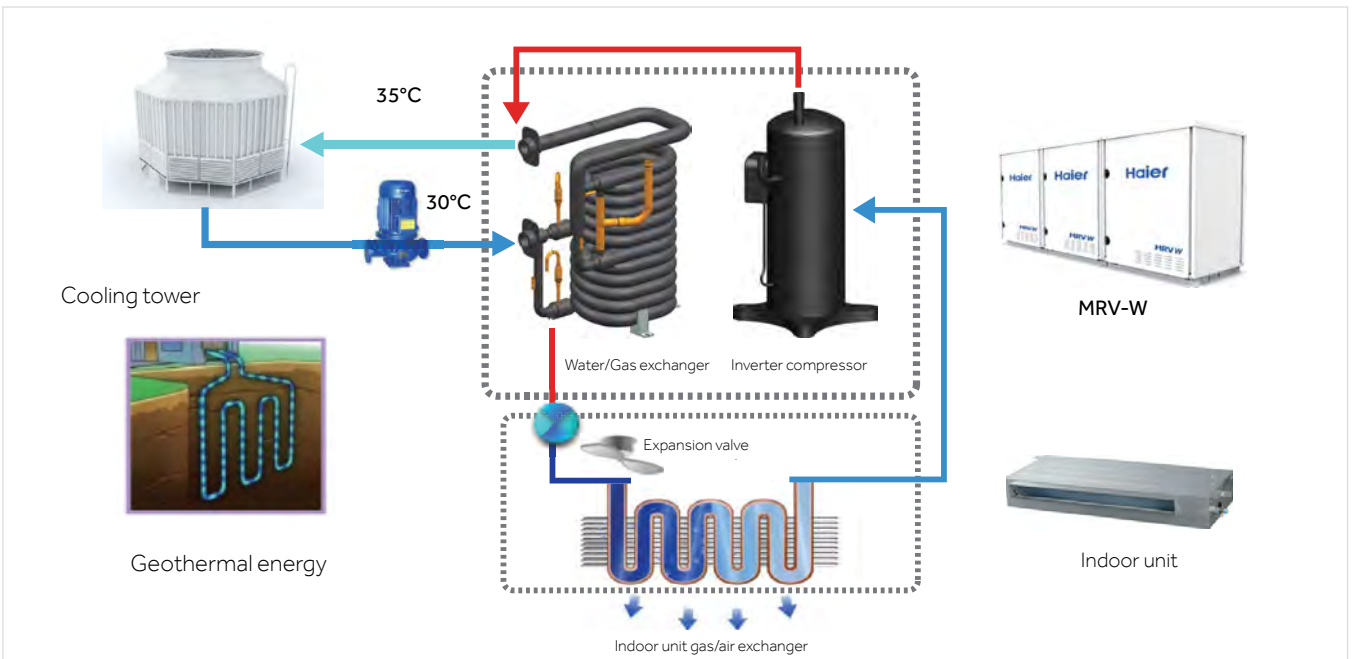

EXAMPLE OF HEATING OPERATION

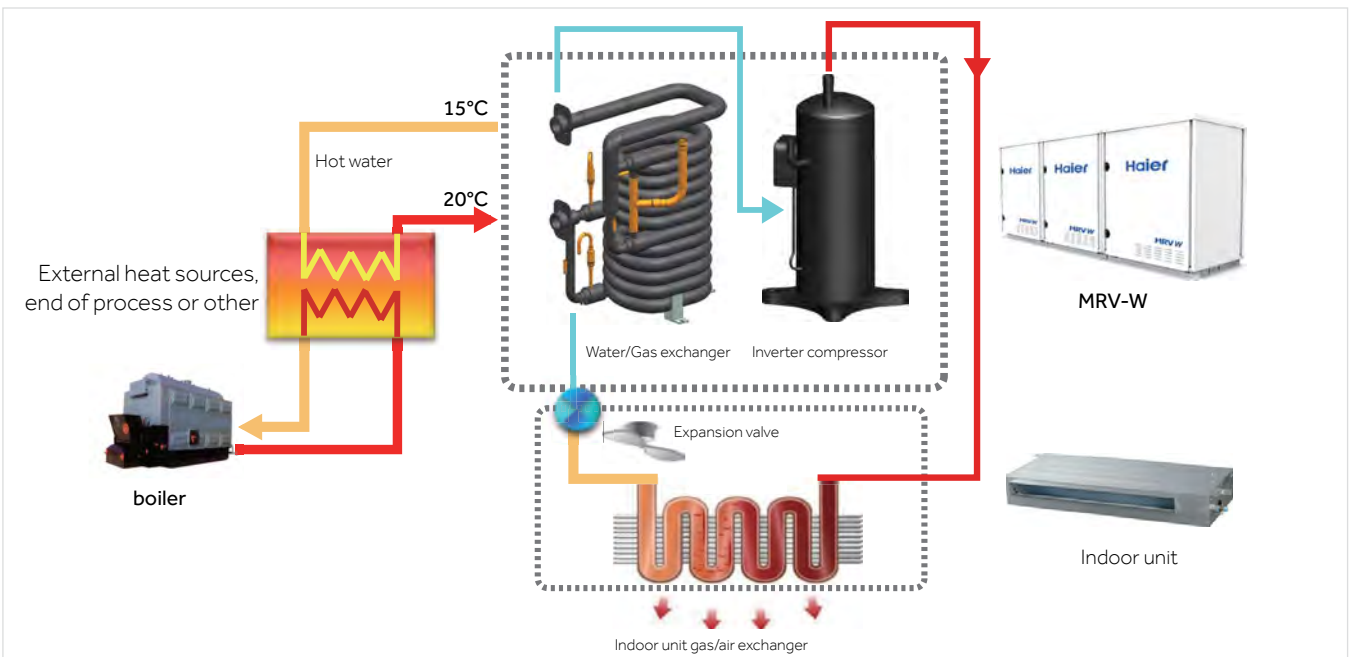

MRV-W - FEATURES

MRV-W INTERNAL STRUCTURE

Refrigerant connections to indoor units

Water entry and exit to the gas/water exchanger

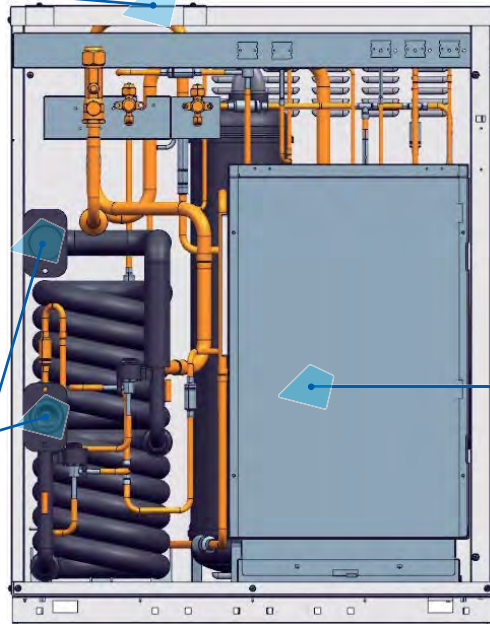

Electrical, compact and easily removable panel to access the compressor

DC Inverter Compressor

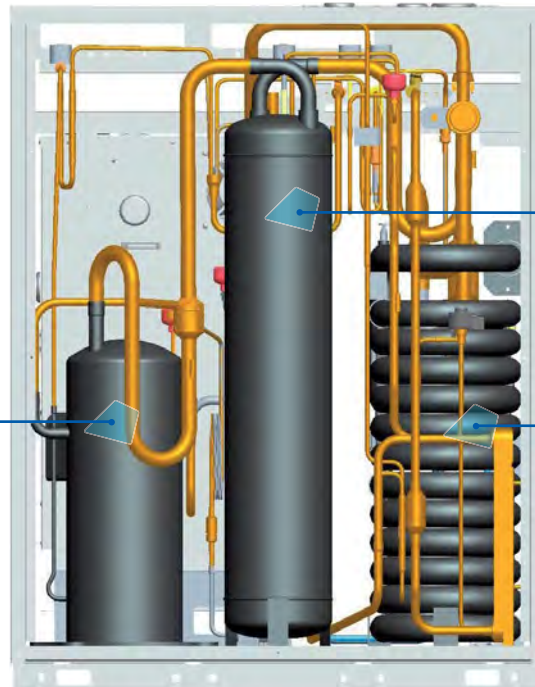

Generous gas separator and liquid refrigerant side.

Double-wrapped "pipe in pipe" gas water exchanger in counter flow, great efficiency and uniformity of exchange.

HIGH EFFICIENCY

Using a constant source, the COP can also reach values of 6.02, much higher than an air/air system. As a result, EER values are also increased in equal proportion.

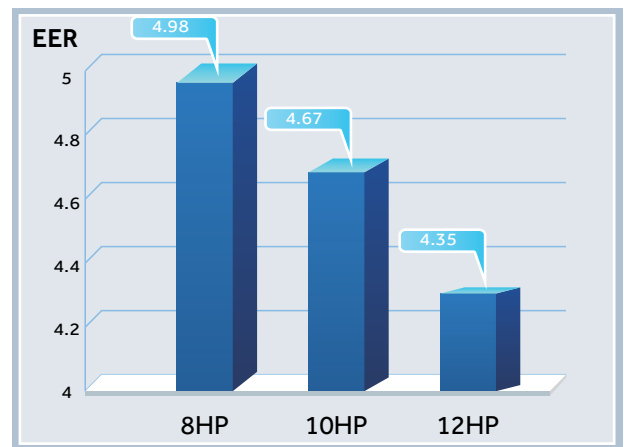
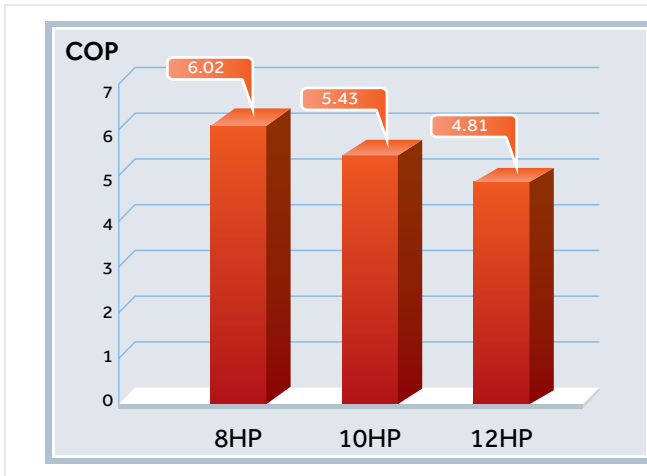

HIGH-EFFICIENCY COMPRESSOR

DC Inverter Scroll



COUNTER CURRENT "PIPE IN PIPE" EXCHANGER

Water circulates inside and refrigerant circulates outside. The internal star-section and spiral tube offers a greater exchange surface than a classic circular section, for the benefit of efficiency.

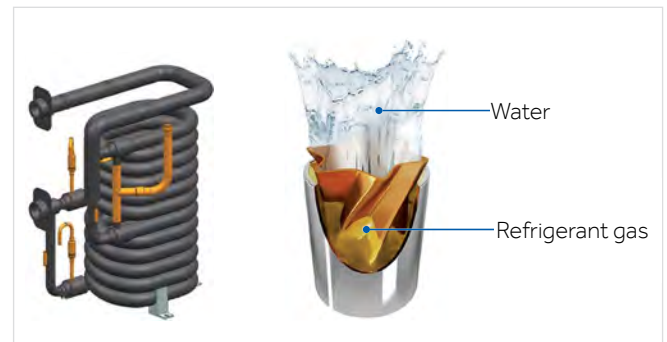

DUAL ELECTRONIC EXPANSION VALVE

To modulate the surface of the active exchanger according to the thermal demand.

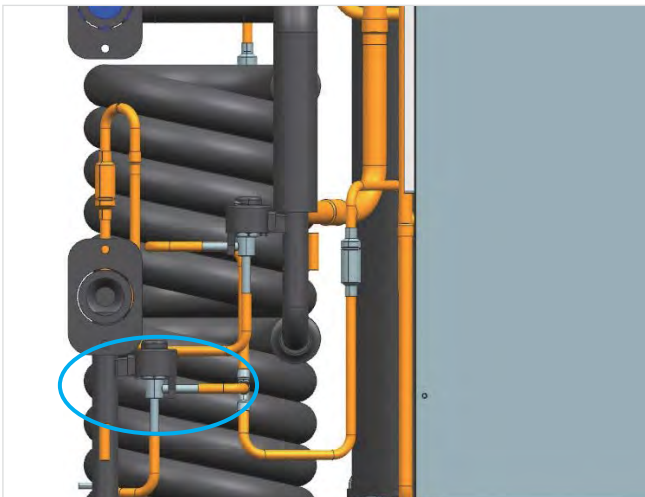

2-SIDED SUB-COOLING SYSTEM

- The first stage acts on the condenser
- The second stage acts independently
- The independent or joint activity of the two stages allows to increase the exchange of refrigerant by 46% and to reduce the loss of load through the pipes by 55%, leading to an increase in overall efficiency of 9% compared to single circuits "Under cooling"

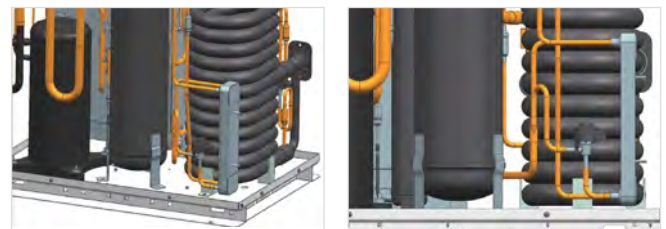

MRV-W - FEATURES

COOLING ELECTRONIC CIRCUITS

The circuits are cooled by special static exchangers where the refrigerant gas circulates inside. This allows you to cool and keep the temperature of the electric panel and power modules constant, avoiding cumbersome sinks and especially the use of noisy electric fans.

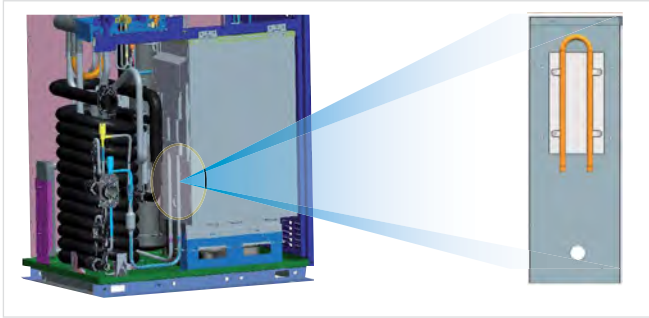

RELIABILITY

The management of the external pump or electro-valves to power the flow of water to the MRV-W systems, is controlled by the unit itself according to the activity of the compressor and the real need for water. Avoiding unnecessary waste of energy.

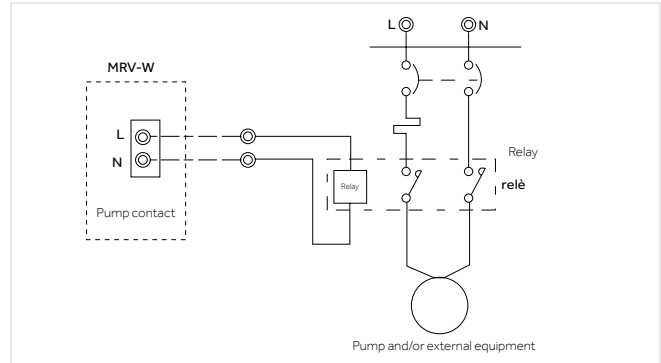

TEMPERATURE RANGE

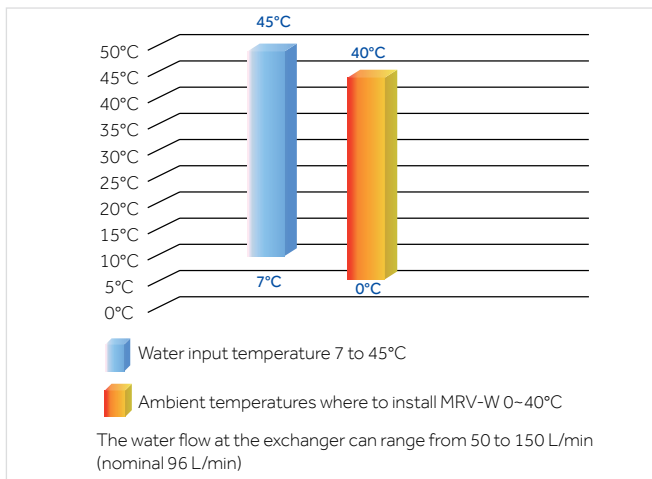

CONSTANT PRESSURE

Accurate system to maintain the pressure adequate to the compressor according to the operating temperature of the refrigerant in order to maintain a more stable output capacity and for the reliability over time of the component itself.

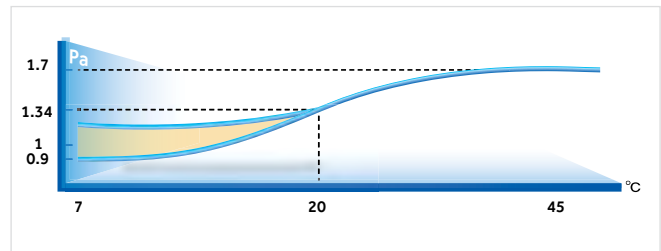

FLEXIBLE INSTALLATION

Using water as a condenser, you can air-condition very tall buildings, where you can reach up to 200 meters in height with a pressure of 1.6 MPa.

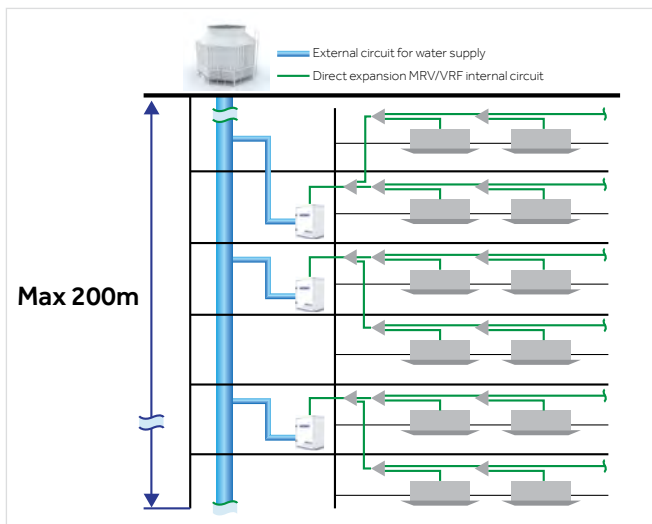

POSSIBLE ENVIRONMENTS WHERE MRV-W CAN BE INSTALLED INDOOR



MRV-W - FEATURES

EXAMPLES OF PIPING LENGTHS

Ability to achieve large elevations and lengths within each floor served by an MRV-W.

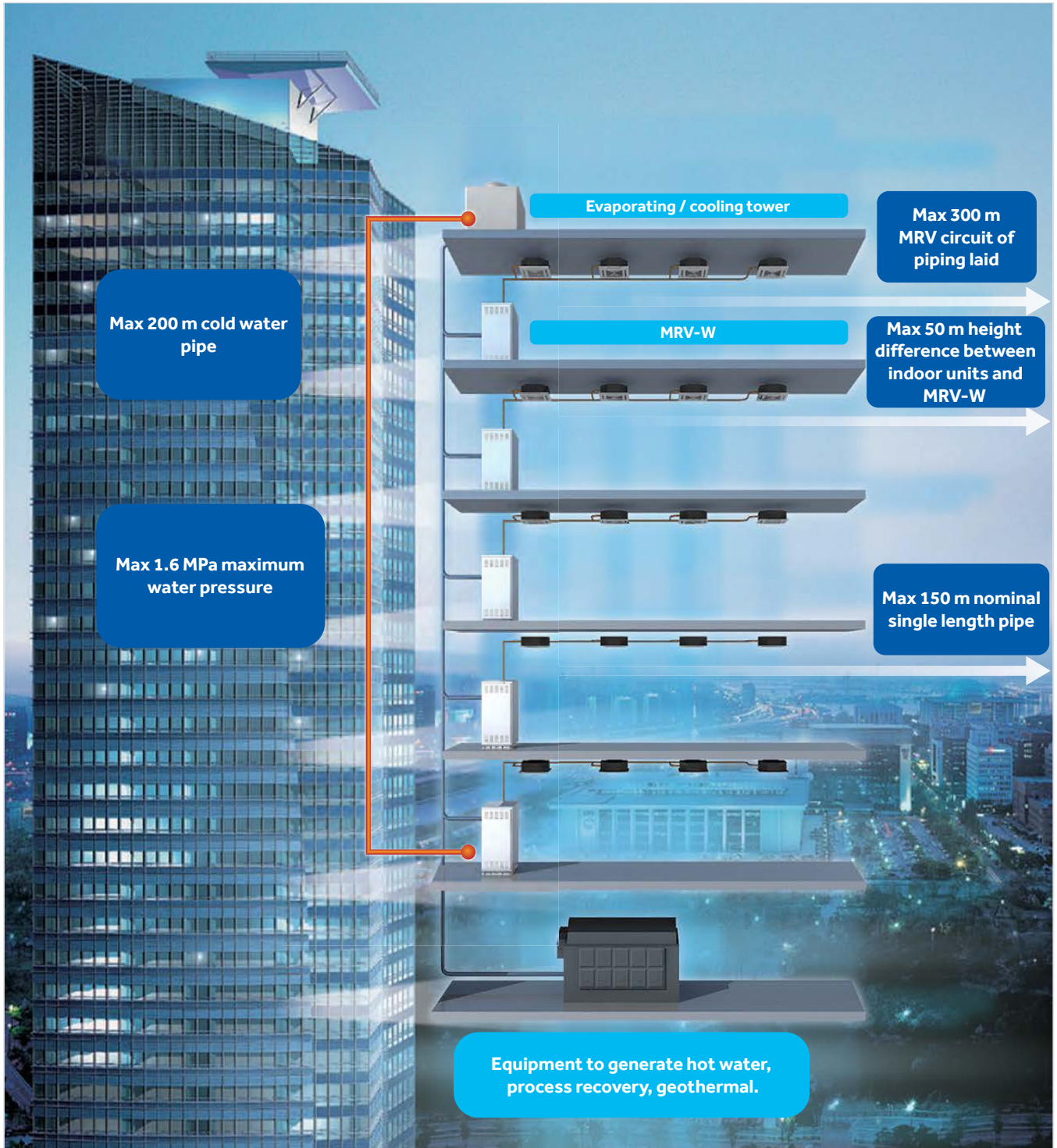



8-12HP

AV08IMWEWA

AV10IMWEWA

AV12IMWEWA

Model		AV08IMWEWA	AV10IMWEWA	AV12IMWEWA
Capacity				
Power Class	HP	8	10	12
Cooling	kW	22,40	28,00	33,50
Heating	kW	25,00	31,50	37,50
Electrical Parameters				
Power supply	Ph-V/Hz	3/380-400/50/60 (5 wires L1+L2+L3+N+T)	3/380-400/50/60 (5 wires L1+L2+L3+N+T)	3/380-400/50/60 (5 wires L1+L2+L3+N+T)
Absorbed power - Cooling	kW	4,50	6,00	7,70
Max absorbed power - Cooling	kW	13,00	15,00	17,00
Absorbed current in cooling.	A	7,20	9,60	12,32
Max absorbed current - Cooling	A	20,79	23,99	27,19
Absorbed power - Heating	kW	4,15	5,80	7,80
Max absorbed power - Heating	kW	13,00	15,00	17,00
Absorbed current in heating	A	6,64	9,28	12,47
Max absorbed current - Heating	A	20,79	23,99	27,19
EER energy class	W/W	4,98	4,67	4,35
COP energy class	W/W	6,02	5,43	4,81
SEER energy class	W/W	5,87	5,76	5,69
SCOP energy class	W/W	6,13	6,01	5,96
Performance				
Water flow (High)	m ³ /h	4,80	6,00	7,20
Sound pressure level (High)	dB(A)	50	51	53
Sound power level (High)	dB(A)	61	62	64
Installation - Dimensions - Components				
Unit Dimensions WxDxH	mm	775x545x995		
Packaged unit dimensions WxDxH	mm	875x655x1128		
Net weight / Gross weight	Kg	172/183	172/183	172/183
Compressor type		DC Inverter Scroll	DC Inverter Scroll	DC Inverter Scroll
Quantity and type of the compressor	No.	1 INV	1 INV	1 INV
Refrigerant type		R410A	R410A	R410A
Pre-charged refrigerant qty.	Kg	2	2	2
Ø Liquid side refrigerant pipe	mm (inch)	9,52 (3/8)	9,52 (3/8)	12,7 (1/2)
Ø Gas side refrigerant pipe	mm (inch)	19,05 (3/4)	22,22 (7/8)	25,40 (1)
Ø OU Oil Equalisation Pipe	mm (inch)	9,52 (3/8)	9,52 (3/8)	9,52 (3/8)
Maximum piping length	m	300	300	300
Max linear piping length (Equivalent/Real)	m	150/120	150/120	150/120
Max height difference between IU and OU (*)	m	50/40	50/40	50/40
Water/gas exchanger				
Type		Double - tube in tube	Double - tube in tube	Double - tube in tube
Material		Copper/steel	Copper/steel	Copper/steel
Water input connection		DN32	DN32	DN32
Water output connection		DN32	DN32	DN32
Exchanger pressure drop	Kpa	35	50	70
Connection type		Internal thread	Internal thread	Internal thread
Max water input pressure	Mpa	1.6	1.6	1.6
Water input temperature range (Cooling/ Heating)	°C	7-45	7-45	7-45
Connectable Indoor Capacity Ratio				
Indoor / Outdoor Capacity Ratio	%	50-130	50-130	50-130
Maximum number of connectable IUs	No.	13	16	19

(*1) 50 m when the outdoor unit is above the indoor unit / 40 m when it is below

The specifications indicated are obtained with the following test conditions: in Cooling mode, Indoor temperature of 27°C WB / 19°C DB and Outdoor temperature of 35°C WB / 24°C DB. In Heating mode, Indoor temperature of 20°C WB and Outdoor temperature of 7°C WB / 6°C DB

Outdoor Units

MRV-W

Haier

MRV W



16-24HP

AV08IMWEWA

AV10IMWEWA

AV12IMWEWA

Model		AV16IMWEWA AV08IMWEWA AV08IMWEWA	AV18IMWEWA AV08IMWEWA AV10IMWEWA	AV20IMWEWA AV10IMWEWA AV10IMWEWA	AV22IMWEWA AV10IMWEWA AV12IMWEWA	AV24IMWEWA AV12IMWEWA AV12IMWEWA
Capacity						
Power Class	HP	16	18	20	22	24
Cooling	kW	44,80	50,40	56,00	61,50	67,00
Heating	kW	50,00	56,50	63,00	69,00	75,00
Electrical Parameters						
Power supply	Ph-V/Hz	3/380-400/50/60 (5 wires L1+L2+L3+N+T)	3/380-400/50/60 (5 wires L1+L2+L3+N+T)	3/380-400/50/60 (5 wires L1+L2+L3+N+T)	3/380-400/50/60 (5 wires L1+L2+L3+N+T)	3/380-400/50/60 (5 wires L1+L2+L3+N+T)
Absorbed power - Cooling	kW	9,00	10,50	12,00	13,70	15,40
Max absorbed power - Cooling	kW	26,00	28,00	30,00	32,00	34,00
Absorbed current in cooling	A	14,39	16,79	19,19	21,91	24,63
Max absorbed current - Cooling	A	41,58	44,78	47,98	51,18	54,38
Absorbed power - Heating	kW	8,30	9,95	11,60	13,60	15,60
Max absorbed power - Heating	kW	26,00	28,00	30,00	32,00	34,00
Absorbed current in heating	A	13,27	15,91	18,55	21,75	24,95
Max absorbed current - Heating	A	41,58	44,78	47,98	51,18	54,38
EER energy class	W/W	4,98	4,8	4,67	4,49	4,35
COP energy class	W/W	6,02	5,68	5,43	5,07	4,81
SEER energy class	W/W	5,87	5,82	5,76	5,73	5,69
SCOP energy class	W/W	6,13	6,10	6,01	5,98	5,96
Performance						
Water flow (High)	m ³ /h	9,60	10,80	12,00	13,20	14,40
Sound pressure level (High)	dB(A)	53	54	54	55	56
Sound power level (High)	dB(A)	64	65	65	66	67
Installation - Dimensions - Components						
Unit Dimensions WxDxH	mm	775x545x995+775x545x995				
Packaged unit dimensions WxDxH	mm	875x655x1128+875x655x1128				
Net weight / Gross weight	Kg	344/366	344/366	344/366	344/366	344/366
Compressor type		DC Inverter Scroll	DC Inverter Scroll	DC Inverter Scroll	DC Inverter Scroll	DC Inverter Scroll
Quantity and type of the compressor	No.	2 INV	2 INV	2 INV	2 INV	2 INV
Refrigerant type		R410A	R410A	R410A	R410A	R410A
Pre-charged refrigerant qty.	Kg	4	4	4	4	4
Ø Liquid side refrigerant pipe	mm (inch)	12,7 (1/2)	15,88 (5/8)	15,88 (5/8)	15,88 (5/8)	15,88 (5/8)
Ø Gas side refrigerant pipe	mm (inch)	28,58 (1 - 1/8)	28,58 (1 - 1/8)	28,58 (1 - 1/8)	28,58 (1 - 1/8)	28,58 (1 - 1/8)
Ø OU Oil Equalisation Pipe	mm (inch)	99,52 (3/8)	9,52 (3/8)	9,52 (3/8)	9,52 (3/8)	9,52 (3/8)
Maximum piping length	m	300	300	300	300	300
Max linear piping length (Equivalent/Real)	m	150/120	150/120	150/120	150/120	150/120
Max height difference between IU and OU (*)	m	50/40	50/40	50/40	50/40	50/40
Water/gas exchanger						
Type		Double - tube in tube	Double - tube in tube	Double - tube in tube	Double - tube in tube	Double - tube in tube
Material		Copper/steel	Copper/steel	Copper/steel	Copper/steel	Copper/steel
Water input connection		DN32	DN32	DN32	DN32	DN32
Water output connection		DN32	DN32	DN32	DN32	DN32
Exchanger pressure drop	Kpa	35+35	35+50	50+50	50+70	70+70
Connection type		Internal thread	Internal thread	Internal thread	Internal thread	Internal thread
Max water input pressure	Mpa	1,6	1,6	1,6	1,6	1,6
Water input temperature range (Cooling/Heating)	°C	7-45	7-45	7-45	7-45	7-45
Connectable Indoor Capacity Ratio						
Indoor / Outdoor Capacity Ratio	%	50-130	50-130	50-130	50-130	50-130
Maximum number of connectable IUs	No.	23	29	33	36	39

(*1) 50 m when the outdoor unit is above the indoor unit / 40 m when it is below

The specifications indicated are obtained with the following test conditions: In Cooling mode, Indoor temperature of 27°C WB / 19°C DB and Outdoor temperature of 35°C WB / 24°C DB. In Heating mode, Indoor temperature of 20°C WB and Outdoor temperature of 7°C WB / 6°C DB

The data in this catalogue is purely indicative as the data may vary. Please be advised to check the accuracy of the data with the supplier before purchasing products.



26-30HP

AV08IMWEWA

AV10IMWEWA

AV12IMWEWA

Model		AV26IMWEWA AV08IMWEWA AV08IMWEWA AV10IMWEWA	AV28IMWEWA AV08IMWEWA AV10IMWEWA AV10IMWEWA	AV30IMWEWA AV10IMWEWA AV10IMWEWA AV10IMWEWA
Capacity				
Power Class	HP	26	28	30
Cooling	kW	72,80	78,40	84,00
Heating	kW	81,50	88,00	94,50
Electrical Parameters				
Power supply	Ph-V/Hz	3/380-400/50/60 (5 wires L1+L2+L3+N+T)	3/380-400/50/60 (5 wires L1+L2+L3+N+T)	3/380-400/50/60 (5 wires L1+L2+L3+N+T)
Absorbed power - Cooling	kW	15,00	16,50	18,00
Max absorbed power - Cooling	kW	41,00	43,00	45,00
Absorbed current in cooling.	A	23,99	26,39	28,79
Max absorbed current - Cooling	A	65,57	68,77	71,97
Absorbed power - Heating	kW	14,10	15,75	17,40
Max absorbed power - Heating	kW	41,00	43,00	45,00
Absorbed current in heating	A	22,55	25,19	27,83
Max absorbed current - Heating	A	65,57	68,77	71,97
EER energy class	W/W	4,85	4,75	4,67
COP energy class	W/W	5,78	5,59	5,43
SEER energy class	W/W	5,84	5,8	5,76
SCOP energy class	W/W	6,11	6,1	6,01
Performance				
Water flow (High)	m ³ /h	15,60	16,80	18,00
Sound pressure level (High)	dB(A)	55	55	56
Sound power level (High)	dB(A)	66	66	67
Installation - Dimensions - Components				
Unit Dimensions WxDxH	mm	775x545x995+775x545x995+775x545x995		
Packaged unit dimensions WxDxH	mm	875x655x1128+875x655x1128+875x655x1128		
Net weight / Gross weight	Kg	516/549	516/549	516/549
Compressor type		DC Inverter Scroll	DC Inverter Scroll	DC Inverter Scroll
Quantity and type of the compressor	No.	3 INV	3 INV	3 INV
Refrigerant type		R410A	R410A	R410A
Pre-charged refrigerant qty.	Kg	6	6	6
Ø Liquid side refrigerant pipe	mm (inch)	19,05 (3/4)	19,05 (3/4)	19,05 (3/4)
Ø Gas side refrigerant pipe	mm (inch)	31,80 (1-1/4)	31,80 (1-1/4)	31,80 (1-1/4)
Ø OU Oil Equalisation Pipe	mm (inch)	9,52 (3/8)	9,52 (3/8)	9,52 (3/8)
Maximum piping length	m	300	300	300
Max linear piping length (Equivalent/Real)	m	150/120	150/120	150/120
Max height difference between IU and OU (*)	m	50/40	50/40	50/40
Water/gas exchanger				
Type		Double - tube in tube	Double - tube in tube	Double - tube in tube
Material		Copper/steel	Copper/steel	Copper/steel
Water input connection		DN32	DN32	DN32
Water output connection		DN32	DN32	DN32
Exchanger pressure drop	Kpa	35+35+50	35+50+50	50+50+50
Connection type		Internal thread	Internal thread	Internal thread
Max water input pressure	Mpa	1,6	1,6	1,6
Water input temperature range (Cooling/ Heating)	°C	7-45	7-45	7-45
Connectable Indoor Capacity Ratio				
Indoor / Outdoor Capacity Ratio	%	50-130	50-130	50-130
Maximum number of connectable IUs	No.	43	46	50

(*1) 50 m when the outdoor unit is above the indoor unit / 40 m when it is below

The specifications indicated are obtained with the following test conditions: in Cooling mode, Indoor temperature of 27°C WB / 19°C DB and Outdoor temperature of 35°C WB / 24°C DB. In Heating mode, Indoor temperature of 20°C WB and Outdoor temperature of 7°C WB / 6°C DB

Outdoor Units

MRV-W



32-36HP

AV08IMWEWA

AV10IMWEWA

AV12IMWEWA

Model		AV32IMWEWA AV10IMWEWA AV10IMWEWA AV12IMWEWA	AV34IMWEWA AV10IMWEWA AV12IMWEWA AV12IMWEWA	AV36IMWEWA AV12IMWEWA AV12IMWEWA
Capacity				
Power Class	HP	32	34	36
Cooling	kW	89,50	95,00	100,50
Heating	kW	100,50	106,50	112,50
Electrical Parameters				
Power supply	Ph-V/Hz	3/380-400/50/60 (5 wires L1+L2+L3+N+T)	3/380-400/50/60 (5 wires L1+L2+L3+N+T)	3/380-400/50/60 (5 wires L1+L2+L3+N+T)
Absorbed power - Cooling	kW	19,70	21,40	23,10
Max absorbed power - Cooling	kW	47,00	49,00	51,00
Absorbed current in cooling.	A	31,51	34,23	36,95
Max absorbed current - Cooling	A	75,17	78,37	81,57
Absorbed power - Heating	kW	19,40	21,40	23,40
Max absorbed power - Heating	kW	47,00	49,00	51,00
Absorbed current in heating	A	31,03	34,23	37,42
Max absorbed current - Heating	A	75,17	78,37	81,57
EER energy class	W/W	4,54	4,44	4,35
COP energy class	W/W	5,18	4,98	4,81
SEER energy class	W/W	5,74	5,72	5,69
SCOP energy class	W/W	5,99	5,97	5,96
Performance				
Water flow (High)	m ³ /h	19,20	20,40	21,60
Sound pressure level (High)	dB(A)	57	57	58
Sound power level (High)	dB(A)	68	68	69
Installation - Dimensions - Components				
Unit Dimensions WxDxH	mm	775x545x995+775x545x995+775x545x995		
Packaged unit dimensions WxDxH	mm	875x655x1128+875x655x1128+875x655x1128		
Net weight / Gross weight	Kg	516/549	516/549	516/549
Compressor type		DC Inverter Scroll	DC Inverter Scroll	DC Inverter Scroll
Quantity and type of the compressor	No.	3 INV	3 INV	3 INV
Refrigerant type		R410A	R410A	R410A
Pre-charged refrigerant qty.	Kg	6	6	6
Ø Liquid side refrigerant pipe	mm (inch)	19,05 (3/4)	19,05 (3/4)	19,05 (3/4)
Ø Gas side refrigerant pipe	mm (inch)	31,80 (1-1/4)	31,80 (1-1/4)	31,80 (1-1/2)
Ø OU Oil Equalisation Pipe	mm (inch)	9,52 (3/8)	9,52 (3/8)	9,52 (3/8)
Maximum piping length	m	300	300	300
Max linear piping length (Equivalent/Real)	m	150/120	150/120	150/120
Max height difference between IU and OU (*)	m	50/40	50/40	50/40
Water/gas exchanger				
Type		Double - tube in tube	Double - tube in tube	Double - tube in tube
Material		Copper/steel	Copper/steel	Copper/steel
Water input connection		DN32	DN32	DN32
Water output connection		DN32	DN32	DN32
Exchanger pressure drop	Kpa	50+50+70	50+70+70	70+70+70
Connection type		Internal thread	Internal thread	Internal thread
Max water input pressure	Mpa	1,6	1,6	1,6
Water input temperature range (Cooling/ Heating)	°C	7-45	7-45	7-45
Connectable Indoor Capacity Ratio				
Indoor / Outdoor Capacity Ratio	%	50-130	50-130	50-130
Maximum number of connectable IUs	No.	53	56	59

(*1) 50 m when the outdoor unit is above the indoor unit / 40 m when it is below

The specifications indicated are obtained with the following test conditions: in Cooling mode, Indoor temperature of 27°C WB / 19°C DB and Outdoor temperature of 35°C WB / 24°C DB. In Heating mode, Indoor temperature of 20°C WB and Outdoor temperature of 7°C WB / 6°C DB

The data in this catalogue is purely indicative as the data may vary. Please be advised to check the accuracy of the data with the supplier before purchasing products.





MRV

Indoor Units

Cassette Smart Flow

4-Way Cassette compact

Wall Mounted

1-Way Cassette

2-Way Cassette

Ceiling-Floor

Slim Duct Low Pressure

Ducted Medium Pressure

Ducted High Pressure

Floor console, built-in

Floor Console
exposed type, double flow

Fresh Air Duct

Hydrobox

Wide range of OPTIONAL controllers.
Indoor units are NOT equipped with controller.





AB072MRERA
AB092MRERA
AB122MRERA
AB162MRERA
AB182MRERA
AB242MRERA

These controllers does not allow individual vane control.



Optional controller
HW-BA116ABK



Optional controller
HW-BA101ABT



Optional controller
YR-E17A



Optional remote control
YR-HQS01



Optional controller
YR-E16B

- Exclusive 360° air flow system for a uniform air distribution
- Independent control of the 4 vanes
- 6 levels of positioning per individual vane
- DC inverter fan motor
- 5 fan speeds ONLY selectable with wired controller YR-E16B, YR-E17A and with wireless controller YR-HQS01.
- Standard condensate drain pump with 700mm lift.
- Preparation for fresh air input (pre-cut)



Model		AB072MRERA	AB092MRERA	AB122MRERA	AB162MRERA	AB182MRERA	AB242MRERA
Capacity							
Cooling	kW	2,20	2,80	3,60	4,50	5,60	7,10
Heating	kW	2,50	3,20	4,00	5,00	6,30	8,00
Electrical Parameters							
Power supply	Ph-V/Hz	1/220-230/50/60	1/220-230/50/60	1/220-230/50/60	1/220-230/50/60	1/220-230/50/60	1/220-230/50/60
Ventilation							
Air flow (H/M/L)	m ³ /h	1000/810/620	1000/810/620	1000/810/620	1000	1000	1380
Sound pressure (H/M/L)	dB(A)	30/27/25	30/27/25	30/27/25	32/29/27	33/30/29	35/34/31
Installation – Dimensions							
Net dimensions (WxDxH)	mm	840x840x180	840x840x180	840x840x180	840x840x183	840x840x183	840x840x204
Packaged unit dimensions (WxDxH)	mm	983x983x268	983x983x268	983x983x268	983x983x268	983x983x268	983x983x290
Net/gross weight	Kg	25,0/28,0	25,0/28,0	25,0/28,0	28/31	28/31	29/32
Ø Liquid pipe	mm (inch)	6,35 (1/4)	6,35 (1/4)	6,35 (1/4)	6,35 (1/4)	6,35 (1/4)	9,52 (3/8)
Ø Gas pipe	mm (inch)	9,52 (3/8)	9,52 (3/8)	12,70 (1/2)	12,70 (1/2)	12,70 (1/2)	15,88 (5/8)
Panel							
Model		PB-950KB(H)	PB-950KB(H)	PB-950KB(H)	PB-950KB(H)	PB-950KB(H)	PB-950KB(H)
Panel Net dimensions (WxDxH)	mm	950x950x50	950x950x50	950x950x50	950x950x50	950x950x50	950x950x50
Panel Packaging dimensions (WxDxH)	mm	1013x1025x123	1013x1025x123	1013x1025x123	1013x1025x123	1013x1025x123	1013x1025x123
Panel Net/gross weight	Kg	6,5/9,0	6,5/9,0	6,5/9,0	6,5/9	6,5/9	6,5/9



AB282MRERA
 AB302MRERA
 AB382MRERA
 AB482MRERA
 AB602MRERA

These controllers does not allow individual vane control.



Optional controller
HW-BA116ABK



Optional controller
HW-BA101ABT

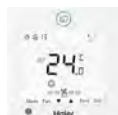

Optional controller
YR-E17A



Optional remote control
YR-HQS01



Optional controller
YR-E16B

- Exclusive 360° air flow system for a uniform air distribution
- Independent control of the 4 vanes
- 6 levels of positioning per individual vane
- DC inverter fan motor
- 5 fan speeds ONLY selectable with wired controller YR-E16B, YR-E17A and with wireless controller YR-HQS01.
- Standard condensate drain pump with 700mm lift
- Preparation for fresh air input (pre-cut)



Model		AB282MRERA	AB302MRERA	AB382MRERA	AB482MRERA	AB602MRERA
Capacity						
Cooling	kW	8,00	9,00	11,20	14,00	16,00
Heating	kW	9,00	10,00	12,50	16,00	18,00
Electrical Parameters						
Power supply	Ph-V/Hz	1/220-230/50/60	1/220-230/50/60	1/220-230/50/60	1/220-230/50/60	1/220-230/50/60
Ventilation						
Air flow (H/M/L)	m ³ /h	1380/1190/1000	2050/1860/1670	2050/1860/1670	2100/1910/1720	2100/1910/1720
Sound pressure (H/M/L)	dB(A)	37/35/31	37/35/31	37/35/31	44/40/36	44/40/36
Installation – Dimensions						
Net dimensions (WxDxH)	mm	840x840x204	840x840x246	840x840x246	840x840x288	840x840x288
Packaged unit dimensions (WxDxH)	mm	983x983x290	983x983x331	983x983x331	983x983x373	983x983x373
Net/gross weight	Kg	27,0/30,0	31,0/36,0	31,0/36,0	33,0/38,0	33,0/38,0
Ø Liquid pipe	mm (inch)	9,52 (3/8)	9,52 (3/8)	9,52 (3/8)	9,52 (3/8)	9,52 (3/8)
Ø Gas pipe	mm (inch)	15,88 (5/8)	15,88 (5/8)	15,88 (5/8)	15,88 (5/8)	15,88 (5/8)
Panel						
Model		PB-950KB(H)	PB-950KB(H)	PB-950KB(H)	PB-950KB(H)	PB-950KB(H)
Panel Net dimensions (WxDxH)	mm	950x950x50	950x950x50	950x950x50	950x950x50	950x950x50
Panel Packaging dimensions (WxDxH)	mm	1013x1025x123	1013x1025x123	1013x1025x123	1013x1025x123	1013x1025x123
Panel Net/gross weight	Kg	6,5/9,0	6,5/9,0	6,5/9,0	6,5/9,0	6,5/9,0



AB052MCERA(M)
 AB072MCERA(M)
 AB092MCERA(M)
 AB122MCERA(M)
 AB162MCERA(M)
 AB182MCERA(M)

These controllers does not allow individual vane control.



Optional controller
HW-BA116ABK



Optional controller
HW-BA101ABT



Optional controller
YR-E17A



Optional remote control
YR-HQS01



Optional controller
YR-E16B

- Panel design max 620x620 dimensions, maximum compatibility with module ceilings
- Independent control of the 4 Vanes
- 6 positioning levels per single vane, with 1296 possible combinations.
- DC inverter fan motor
- 5 fan speeds ONLY selectable with wired controller YR-E16B, YR-E17A and with wireless controller YR-HQS01.
- Standard condensate drain pump
- Preparation for fresh air input (pre-cut)

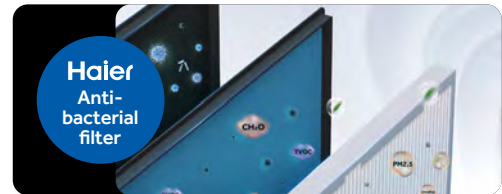

Model		AB052MCERA(M)	AB072MCERA(M)	AB092MCERA(M)	AB122MCERA(M)	AB162MCERA(M)	AB182MCERA(M)
Capacity							
Cooling	kW	1,50	2,20	2,80	3,60	4,50	5,60
Heating	kW	1,70	2,50	3,20	4,00	5,00	6,30
Electrical Parameters							
Power supply	Ph-V/Hz	1/220-240/50/600	1/220-240/50/60	1/220-240/50/60	1/220-240/50/60	1/220-240/50/60	1/220-240/50/60
Ventilation							
Air flow (H/M/L)	m ³ /h	650/540/430	700/590/480	700/590/480	700/590/480	700/590/480	700/590/480
Sound pressure (H/M/L)	dB(A)	32/30/29	32/30/29	32/30/29	33/30/29	33/30/29	34/32/30
Sound power (H/M/L)	dB(A)	46/44/43	46/44/43	46/44/43	47/44/43	47/44/43	48/46/44
Installation – Dimensions							
Net dimensions (WxDxH)	mm	570x570x260	570x570x260	570x570x260	570x570x260	570x570x260	570x570x260
Packaged unit dimensions (WxDxH)	mm	718x680x380	718x680x380	718x680x380	718x680x380	718x680x380	718x680x380
Net/gross weight	Kg	16,0/19,0	16,0/19,0	16,0/19,0	19,0/22,0	19,0/22,0	19,0/22,0
Ø Liquid pipe	mm (inch)	6,35 (1/4)	6,35 (1/4)	6,35 (1/4)	6,35 (1/4)	6,35 (1/4)	6,35 (1/4)
Ø Gas pipe	mm (inch)	9,52 (3/8)	9,52 (3/8)	9,52 (3/8)	12,70 (1/2)	12,70 (1/2)	12,70 (1/2)
Panel							
Model		PB-620KB(H)	PB-620KB(H)	PB-620KB(H)	PB-620KB(H)	PB-620KB(H)	PB-620KB(H)
Panel Net dimensions (WxDxH)	mm	620x620x60	620x620x60	620x620x60	620x620x60	620x620x60	620x620x60
Panel Packaging dimensions (WxDxH)	mm	660x660x115	660x660x115	660x660x115	660x660x115	660x660x115	660x660x115
Panel Net/gross weight	Kg	3.1/4.8	3.1/4.8	3.1/4.8	3.1/4.8	3.1/4.8	3.1/4.8



AS052MNERAB
 AS072MNERAB
 AS092MNERAB
 AS122MNERAB
 AS162MNERA
 AS182MNERA
 AS242MNERA
 AS282MNERA
 AS302MNERA

Optional controller HW-BA116ABK	Optional controller HW-BA101ABT	Optional controller YR-E17A	Optional remote control YR-HRS01	Optional controller YR-E16B

- Compact, linear design with dimmable information display
- Silenced EEV modulation valve
- DC inverter fan motor
- 5 fan speeds selectable with wired controller YR-E16B and YR-E17A.

Model		AS052MNERAB	AS072MNERAB	AS092MNERAB	AS122MNERAB	AS162MNERA	AS182MNERA	AS242MNERA	AS282MNERA	AS302MNERA
Capacity										
Cooling	kW	1,50	2,20	2,80	3,60	4,50	5,60	7,10	8,00	9,00
Heating	kW	1,70	2,50	3,20	4,00	5,00	6,30	8,00	9,00	10,00
Electrical Parameters										
Power supply	Ph-V/Hz	1/220-240/50/60								
Ventilation										
Air flow (H/M/L)	m ³ /h	500/430/370	550/480/420	600/530/470	630/560/500	800/720/650	920/800/720	1010/920/800	1500/1400/1300	1600/1500/1400
Sound pressure (H/M/L)	dB(A)	33/31/29	35/31/29	36/31/29	37/33/29	39/36/34	40/39/35	44/40/36	48/43/40	49/44/41
Sound power (H/M/L)	dB(A)	49/46/41	50/47/42	52/48/44	54/51/50	56/53/51	57/54/52	58/56/54	60/57/53	61/58/54
Installation – Dimensions										
Net dimensions (WxDxH)	mm	855x208x280	855x208x280	855x208x280	855x208x280	1115x243x336	1115x243x336	1115x243x336	1316x270x365	1316x270x365
Packaged unit dimensions (WxDxH)	mm	954x279x355	954x279x355	954x279x355	954x279x355	1206x342x418	1206x342x418	1206x342x418	1403x384x463	1403x384x463
Net/gross weight	Kg	9,9/12,0	9,9/12,0	9,9/12,0	9,9/12,0	15,8/18,9	15,8/18,9	15,8/18,9	21,8/26,3	21,8/26,3
Ø Liquid pipe	mm (inch)	6,35 (1/4)	6,35 (1/4)	6,35 (1/4)	6,35 (1/4)	6,35 (1/4)	6,35 (1/4)	9,52 (3/8)	9,52 (3/8)	9,52 (3/8)
Ø Gas pipe	mm (inch)	9,52 (3/8)	9,52 (3/8)	9,52 (3/8)	12,70 (1/2)	12,70 (1/2)	12,70 (1/2)	15,88 (5/8)	15,88 (5/8)	15,88 (5/8)



AS052MNERAC
AS072MNERAC
AS092MNERAC
AS122MNERAC
AS162MNERAC
AS182MNERAC
AS242MNERAC
AS282MNERAC
AS302MNERAC

The external EEV modulation valve must be installed in the liquid pipe, between 2m and 5m from the unit. This allows to move this sound source out of the room, reaching high levels of silence for the perfect confort in hotels, commerces or offices.



Optional controller
HW-BA116ABK



Optional controller
HW-BA101ABT

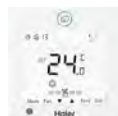

Optional controller
YR-E17A



Optional remote control
YR-HRS01



Optional controller
YR-E16B

- Compact, linear design with dimmable information display
- External EEV modulation valve•
DC inverter fan motor
- 5 fan speeds selectable with wired controller YR-E16B and YR-E17A.

Model		AS052MNERAC	AS072MNERAC	AS092MNERAC	AS122MNERAC	AS162MNERAC	AS182MNERAC	AS242MNERAC	AS282MNERAC	AS302MNERAC
Capacity										
Cooling	kW	1,50	2,20	2,80	3,60	4,50	5,60	7,10	8,00	9,00
Heating	kW	1,70	2,50	3,20	4,00	5,00	6,30	8,00	9,00	10,00
Electrical Parameters										
Power supply	Ph-V/Hz	1/220-240/50/60								
Ventilation										
Air flow (H/M/L)	m ³ /h	500/430/370	550/480/420	600/530/470	630/560/500	800/720/650	920/800/720	1010/920/800	1500/1400/1300	1600/1500/1400
Sound pressure (H/M/L)	dB(A)	33/31/29	35/31/29	36/31/29	37/33/29	39/36/34	40/39/35	44/40/36	48/43/40	49/44/41
Sound power (H/M/L)	dB(A)	49/46/41	50/47/42	52/48/44	54/51/50	56/53/51	57/54/52	58/56/54	60/57/53	61/58/54
Installation – Dimensions										
Net dimensions (WxDxH)	mm	855x208x280	855x208x280	855x208x280	855x208x280	1115x243x336	1115x243x336	1115x243x336	1316x270x365	1316x270x365
Packaged unit dimensions (WxDxH)	mm	1054x279x355	1054x279x355	1054x279x355	1054x279x355	1306x342x418	1306x342x418	1306x342x418	1503x384x463	1503x384x463
Net/gross weight	Kg	9,9/14,2	9,9/14,2	9,9/14,2	9,9/14,2	15,8/21,2	15,8/21,2	15,8/21,2	21,8/27,2	21,8/27,2
Ø Liquid pipe	mm (inch)	6,35 (1/4)	6,35 (1/4)	6,35 (1/4)	6,35 (1/4)	6,35 (1/4)	6,35 (1/4)	9,52 (3/8)	9,52 (3/8)	9,52 (3/8)
Ø Gas pipe	mm (inch)	9,52 (3/8)	9,52 (3/8)	9,52 (3/8)	12,70 (1/2)	12,70 (1/2)	12,70 (1/2)	15,88 (5/8)	15,88 (5/8)	15,88 (5/8)



EXPERT White

- AS20XCAHRA
- AS25XCAHRA
- AS35XCAHRA
- AS50XCAHRA

EXPERT Black

- AS20XCAHRA-MB
- AS25XCAHRA-MB
- AS35XCAHRA-MB
- AS50XCAHRA-MB

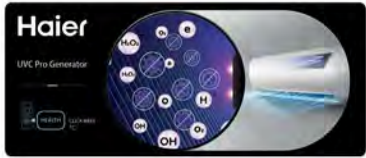

Optional controller^ HW-BA116ABK	Optional controller^ HW-BA101ABT	Optional controller^ YR-E17A	Standard remote control HQ-HJ	Optional controller^ YR-E16B

- Silent performance, down to 16db(A) 2,0kW and 2,5kW
- External EEV modulation valve
- ECO presence sensor to optimize the energy consumption and the airflow
- Standard Wi-Fi with hOn App
- 3D ventilation
- Easy installation thanks to the removable part in the bottom of the unit that gives access to the piping

MS1-036A/MS1-060A



MS3-036A



Model		AS20XCAHRA	AS25XCAHRA	AS35XCAHRA	AS50XCAHRA
Capacity					
Cooling	kW	2.00	2.80	3.50	5.00
Heating	kW	2.50	3.20	4.20	6.00
Electrical Parameters					
Power supply	Ph-V/Hz	1/220-240/50			
Ventilation					
Air flow (H/M/L)	m ³ /h	730	730	800	880
Sound pressure (H/M/L)	dB(A)	39/32/25/16	39/32/25/16	40/33/26/17	45/37/29/20
Sound power (H/M/L)	dB(A)	56	56	57	60
Installation – Dimensions					
Net dimensions (WxDxH)	mm	895x313x236	895x313x236	895x313x236	895x313x236
Packaged unit dimensions (WxDxH)	mm	964x386x316	964x386x316	964x386x316	964x386x316
Net/gross weight	Kg	11,3/14	11,3/14	11,3/14	11,6/14,2
Ø Liquid pipe	mm (inch)	6,35 (1/4)	6,35 (1/4)	6,35 (1/4)	6,35 (1/4)
Ø Gas pipe	mm (inch)	9,52 (3/8)	9,52 (3/8)	9,52 (3/8)	12,7 (1/2)

*Easy MRV kit needed to integrate with MRV system.



^WK-B necessary to connect split high walls with wired controller

WK-B

The data in this catalogue is purely indicative as the data may vary. Please be advised to check the accuracy of the data with the supplier before purchasing products.



FLEXIS PLUS (MW3) White

- AS20S2SF1FA-MW3
- AS25S2SF1FA-MW3
- AS35S2SF1FA-MW3
- AS50S2SF1FA-MW3
- AS71S2SF1FA-MW3

FLEXIS PLUS (MB3) Black

- AS20S2SF1FA-MB3
- AS25S2SF1FA-MB3
- AS35S2SF1FA-MB3
- AS50S2SF1FA-MB3
- AS71S2SF1FA-MB3



Optional controller[^]
HW-BA116ABK



Optional controller[^]
HW-BA101ABT



Optional controller[^]
YR-E17A



Standard remote control
HQ-HJ



Optional controller[^]
YR-E16B

- Silent performance, down to 16db(A) 2,0kW and 2,5kW
- External EEV modulation valve
- ECO presence sensor to optimize the energy consumption and the airflow
- Standard Wi-Fi with hOn App
- 3D ventilation
- Easy installation thanks to the removable part in the bottom of the unit that gives access to the piping

MS1-036A/MS1-060A



MS3-036A



Model	White	AS20S2SF1FA-MW3	AS25S2SF1FA-MW3	AS35S2SF1FA-MW3	AS50S2SF1FA-MW3	AS71S2SF1FA-MW3
	Black	AS20S2SF1FA-MB3	AS25S2SF1FA-MB3	AS35S2SF1FA-MB3	AS50S2SF1FA-MB3	AS71S2SF1FA-MB3
Capacity						
Cooling	kW	2,00	2,60	3,50	5,20	7,00
Heating	kW	2,50	3,20	4,20	6,00	8,00
Electrical Parameters						
Power supply	Ph-V/Hz	1/220-240/50/60				
Ventilation						
Air flow	m ³ /h	600	600	650	900	1100
Sound pressure (H/M/L)	dB(A)	38/32/25/16	38/32/25/16	39/33/26/17	45/41/37/28	47/43/37/33
Sound power	dB(A)	53	53	55	57	60
Installation – Dimensions						
Net dimensions (WxDxH)	mm	856x197x300	856x197x300	856x197x300	999x225x323	1115x235x343
Packaged unit dimensions (WxDxH)	mm	954x279x355	954x279x355	954x279x355	1206x342x418	1206x342x418
Net/gross weight	Kg	9,5/12,0	9,5/12,0	9,5/12,0	12,0/18,9	15,2/18,9
Ø Liquid pipe	mm (inch)	6,35 (1/4)	6,35 (1/4)	6,35 (1/4)	6,35 (1/4)	9,52 (3/8)
Ø Gas pipe	mm (inch)	9,52 (3/8)	9,52 (3/8)	9,52 (3/8)	12,70 (1/2)	15,88 (5/8)

*Easy MRV kit needed to integrate with MRV system.



WK-B





[^]WK-B necessary to connect split high walls with wired controller



PEARL

- AS20PBAHRA
- AS25PBAHRA
- AS35PBAHRA
- AS50PDAHRA
- AS68PDAHRA



 Optional controller [^] HW-BA116ABK	 Optional controller [^] HW-BA101ABT	 Optional controller [^] YR-E17A	 Standard remote control YR-HE	 Optional controller [^] YR-E16B
--	--	--	---	--

- Silent performance, down to 18db(A) 2,0kW and 2,5kW
- External EEV modulation valve
- Standard Wi-Fi with hOn App
- UVC Sterilisation
- Coando Plus airflow

MS1-036A/MS1-060A



MS3-036A



Model		AS20PBAHRA	AS25PBAHRA	AS35PBAHRA	AS50PDAHRA	AS68PDAHRA
Capacity						
Cooling	kW	2.00	2.60	3.50	5.00	6.80
Heating	kW	2.50	2.80	3.50	5.20	6.80
Electrical Parameters						
Power supply	Ph-V/Hz	1/220-240/50				
Ventilation						
Air flow (H/M/L)	m ³ /h	550	550	600	900	1100
Sound pressure (H/M/L)	dB(A)	37/32/28/18	37/32/28/18	37/33/29/19	44/40/35/28	47/45/37/29
Sound power (H/M/L)	dB(A)		54	56	57	62
Installation – Dimensions						
Net dimensions (WxDxH)	mm	805x200x290	805x200x290	805x200x290	975x220x320	975x220x320
Packaged unit dimensions (WxDxH)	mm	874x270x363	874x270x363	874x270x363	1050x301x397	1050x301x397
Net/gross weight	Kg	8,3/10,5	8,3/10,5	8,3/10,5	11,6/14,4	11,6/14,4
Ø Liquid pipe	mm (inch)	6,35 (1/4)	6,35 (1/4)	6,35 (1/4)	6,35 (1/4)	6,35 (1/4)
Ø Gas pipe	mm (inch)	9,52 (3/8)	9,52 (3/8)	9,52 (3/8)	12,7 (1/2)	12,7 (1/2)

*Easy MRV kit needed to integrate with MRV system.



WK-B

[^]WK-B necessary to connect split high walls with wired controller



AB052MAERA
AB072MAERA
AB092MAERA
AB122MAERA



Optional controller
HW-BA116ABK



Optional controller
HW-BA101ABT



Optional controller
YR-E17A



Optional remote control
YR-HRS01



Optional controller
YR-E16B

- Modern, thin and linear design panel
- Automatic opening and closing of air discharge and air intake louvres
- 3D ventilation
- DC inverter fan motor
- 5 fan speeds selectable with wired controller YR-E16B and YR-E17A.
- Quiet and thin
- Standard intake filter
- Standard condensate drain pump

Model		AB052MAERA	AB072MAERA	AB092MAERA	AB122MAERA
Capacity					
Cooling	kW	1,50	2,20	2,80	3,60
Heating	kW	1,70	2,50	3,20	4,00
Electrical Parameters					
Power supply	Ph-V/Hz	1/220-230/50/60	1/220-230/50/60	1/220-230/50/60	1/220-230/50/60
Ventilation					
Air flow (High)	m ³ /h	530/490/450	530/490/450	530/490/450	550/530/490
Sound pressure (H/M/L)	dB(A)	32/29/24	32/29/24	32/29/24	34/30/25
Sound power (H/M/L)	dB(A)	46/43/38	46/43/38	46/43/38	48/44/39
Installation – Dimensions					
Net dimensions (WxDxH)	mm	875x505x185	875x505x185	875x505x185	875x505x185
Packaged unit dimensions (WxDxH)	mm	1028x581x270	1028x581x270	1028x581x270	1028x581x270
Net/gross weight	Kg	15,3/17,9	15,3/17,9	15,3/17,9	15,3/17,9
Ø Liquid pipe	mm (inch)	6,35 (1/4)	6,35 (1/4)	6,35 (1/4)	6,35 (1/4)
Ø Gas pipe	mm (inch)	9,52 (3/8)	9,52 (3/8)	9,52 (3/8)	12,70 (1/2)
Panel					
Model		P1B-1050IB	P1B-1050IB	P1B-1050IB	P1B-1050IB
Panel Net dimensions (WxDxH)	mm	1050x560x122	1050x560x122	1050x560x122	1050x550x125
Panel Packaging dimensions (WxDxH)	mm	1133x623x197	1133x623x197	1133x623x197	1133x623x197
Panel Net/gross weight	Kg	5,3/8,3	5,3/8,3	5,3/8,3	5,3/8,3



AB072MBERA
 AB092MBERA
 AB122MBERA
 AB162MBERA
 AB182MBERA



Optional controller
HW-BA116ABK



Optional controller
HW-BA101ABT



Optional controller
YR-E17A



optional remote control YR-HRS01
(RE-02 remote control receiver)



Optional controller
YR-E16B

- Thin design, only 220 mm high
- Standard condensate drain pump
- Silent operation

Model		AB072MBERA	AB092MBERA	AB122MBERA	AB162MBERA	AB182MBERA
Capacity						
Cooling	kW	2,20	2,80	3,60	4,50	5,60
Heating	kW	2,50	3,20	4,00	5,00	6,30
Electrical Parameters						
Power supply	Ph-V/Hz	1/220-230/50/60	1/220-230/50/60	1/220-230/50/60	1/220-230/50/60	1/220-230/50/60
Ventilation						
Air flow (H/M/L)	m ³ /h	840/700/550	840/700/550	840/700/550	840/700/550	840/700/550
Sound pressure (H/M/L)	dB(A)	42/37/33	42/37/33	42/37/33	44/39/34	44/39/34
Sound power (H/M/L)	dB(A)	55/50/46	55/50/46	55/50/46	57/52/47	57/52/47
Installation – Dimensions						
Net dimensions (WxDxH)	mm	817x620x220	817x620x220	817x620x220	817x620x220	817x620x220
Packaged unit dimensions (WxDxH)	mm	1015x695x278	1015x695x278	1015x695x278	1015x695x278	1015x695x278
NNet/gross weight	Kg	21,0/23,0	21,0/23,0	21,0/23,0	21,0/23,0	21,0/23,0
Ø Liquid pipe	mm (inch)	6,35 (1/4)	6,35 (1/4)	6,35 (1/4)	6,35 (1/4)	6,35 (1/4)
Ø Gas pipe	mm (inch)	9,52 (3/8)	9,52 (3/8)	12,70 (1/2)	12,70 (1/2)	12,70 (1/2)
Panel						
Model		P2B-1055IB	P2B-1055IB	P2B-1055IB	P2B-1055IB	P2B-1055IB
Panel Net dimensions (WxDxH)	mm	1055x680x68	1055x680x68	1055x680x68	1055x680x68	1055x680x68
PPanel Packaging dimensions (WxDxH)	mm	1110x720x161	1110x720x161	1110x720x161	1110x720x161	1110x720x161
Panel Net/gross weight	Kg	7,0/8,0	7,0/8,0	7,0/8,0	7,0/8,0	7,0/8,0



AC092MDERA
AC122MDERA
AC162MDERA
AC182MDERA
AC242MDERA
AC282MDERA
AC302MDERA
AC382MDERA
AC482MDERA

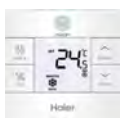

Optional controller
HW-BA116ABK

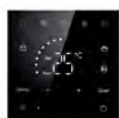

Optional controller
HW-BA101ABT



Optional controller
YR-E17A



Optional remote control
YR-HRS01



Optional controller
YR-E16B

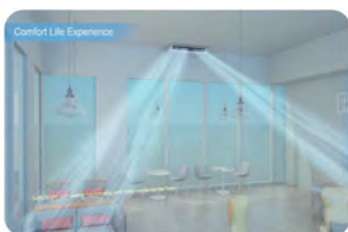

- New design, subtle and harmonious
- DC inverter fan motor
- 5 fan speeds selectable with wired controller YR-E16B and YR-E17A.
- 3D ventilation with independent right and left wing group
- Outstanding installation height - the 14kW model can be installed up to 4.2 m high still ensuring adequate air distribution in the environment

Model		AC092MDERA	AC122MDERA	AC162MDERA	AC182MDERA	AC242MDERA	AC282MDERA	AC302MDERA	AC382MDERA	AC482MDERA
Capacity										
Cooling	kW	2,80	3,60	4,50	5,60	7,10	8,00	9,00	11,20	14,00
Heating	kW	3,20	4,00	5,00	6,30	8,00	9,00	10,00	12,50	16,00
Electrical Parameters										
Power supply	Ph-V/Hz	1/220-230/50/60								
Ventilation										
Air flow (H/M/L)	m ³ /h	820/750/690	820/750/690	950/820/690	950/820/690	1420/1270/1240	1570/1420/1240	1570/1420/1240	2110/1990/1750	2110/1990/1750
Sound pressure (H/M/L)	dB(A)	38/36/34	38/36/34	42/38/35	42/38/35	46/44/41	47/44/41	47/44/41	50/46/43	50/46/43
Sound power (H/M/L)	dB(A)	52/50/47	52/50/47	55/51/48	55/51/48	60/58/54	61/58/54	61/58/55	63/60/57	63/60/57
Installation – Dimensions										
Net dimensions (WxDxH)	mm	1000x230x680				1325x230x680			1650x230x680	
Packaged unit dimensions (WxDxH)	mm	1100x305x779				1425x305x779			1750x305x779	
Net/gross weight	Kg	27.9/33.6	27.9/33.6	27.9/33.6	27.9/33.6	35.8/42.1	35.8/42.1	35.8/42.1	43.5/50.5	43.5/50.5
Ø Liquid pipe	mm (inch)	6,35 (1/4)	6,35 (1/4)	6,35 (1/4)	6,35 (1/4)	9,52 (3/8)	9,52 (3/8)	9,52 (3/8)	9,52 (3/8)	9,52 (3/8)
Ø Gas pipe	mm (inch)	9,52 (3/8)	12,70 (1/2)	12,70 (1/2)	12,70 (1/2)	15,88 (5/8)	15,88 (5/8)	15,88 (5/8)	15,88 (5/8)	15,88 (5/8)

MRV SLIM DUCT – HEALTH FEATURES

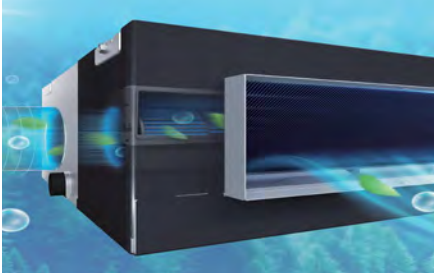

Healthier air flow

Mold and bacteria are unable to grow on the components where air flows through, with help from silver ions, which bring no harm to human health. This process means the unit always produces clean and healthy air.

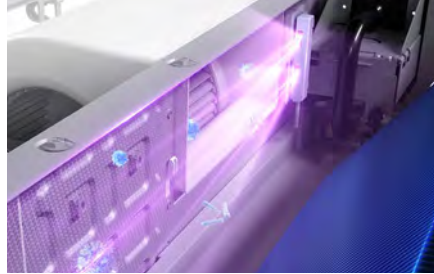

UVC Sterilisation

The built-in UVC sterilisation function emits UV light to sterilise the air passing through with an efficiency of 99.998%.

Texcell



Antibacterial filter

Silver (Ag) is a natural antibacterial material, which has a broad-spectrum of antibacterial properties which help to kill bacterial.

Haier's antibacterial filter has added silver ions and antibacterial organics to kill Escherichia coli & Staphylococcus aureus effectively, with long lasting effects.

Self-clean function

During operation, dirt accumulates on the evaporator. If the evaporator is not cleaned regularly, accumulated dirt reduces the thermal exchange by 15-30% and also promotes the proliferation of bacteria and mould.

Self Clean technology is the first of its kind to integrate the self-cleaning function of both the evaporator and the condenser. It starts with cleaning the evaporator, then switches to cleaning the condenser without stopping the compressor.

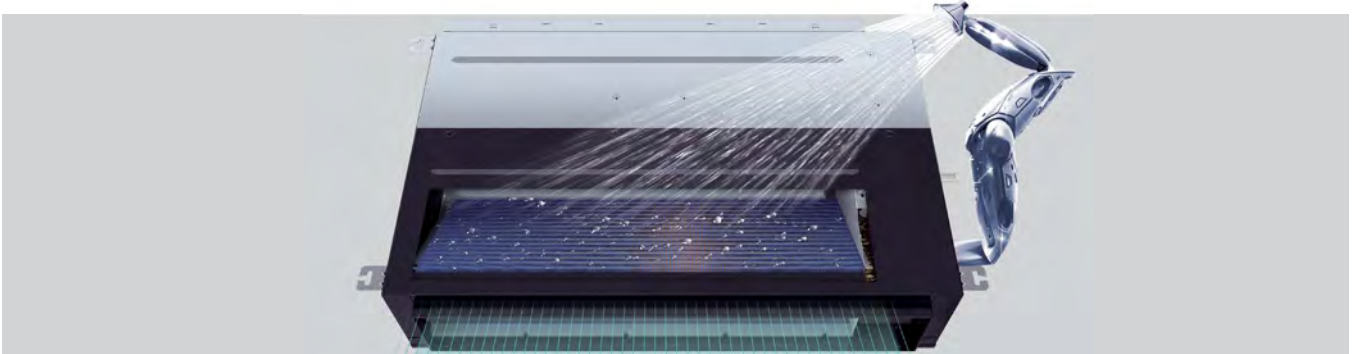

Cold expansion technology



The layer of frost that forms on the evaporator/condenser generates a strong force of cold expansion that easily removes dirt from the surface.

Express washing technology



Low-angle hydrophilic aluminium foil speeds up water drainage by 20%.

Antibacterial technology



The coating contains silver nanoparticles capable of effectively killing 99% of the bacteria by inhibiting their proliferation.

MRV SLIM DUCT – 3D AIR SUPPLY

High quality components

Robust and high quality materials used for the fascia means that it is resistant to high temperatures.

Modern display

Simple and low profile temperature display with colour indication of cooling or heating mode.

Easy Disassembly

Quick access to the air inlet grille which allows for easy cleaning.

Aesthetic design

The Modern and streamline design of the MRV Slim Duct unit comes with a simple white front and underside panel to suit any interior environment.

Three-dimensional air supply

With a free vertical range of motion between 30-80 degrees and a horizontal range of motion of around 90 degrees, this provides a three dimensional air flow for your environment.

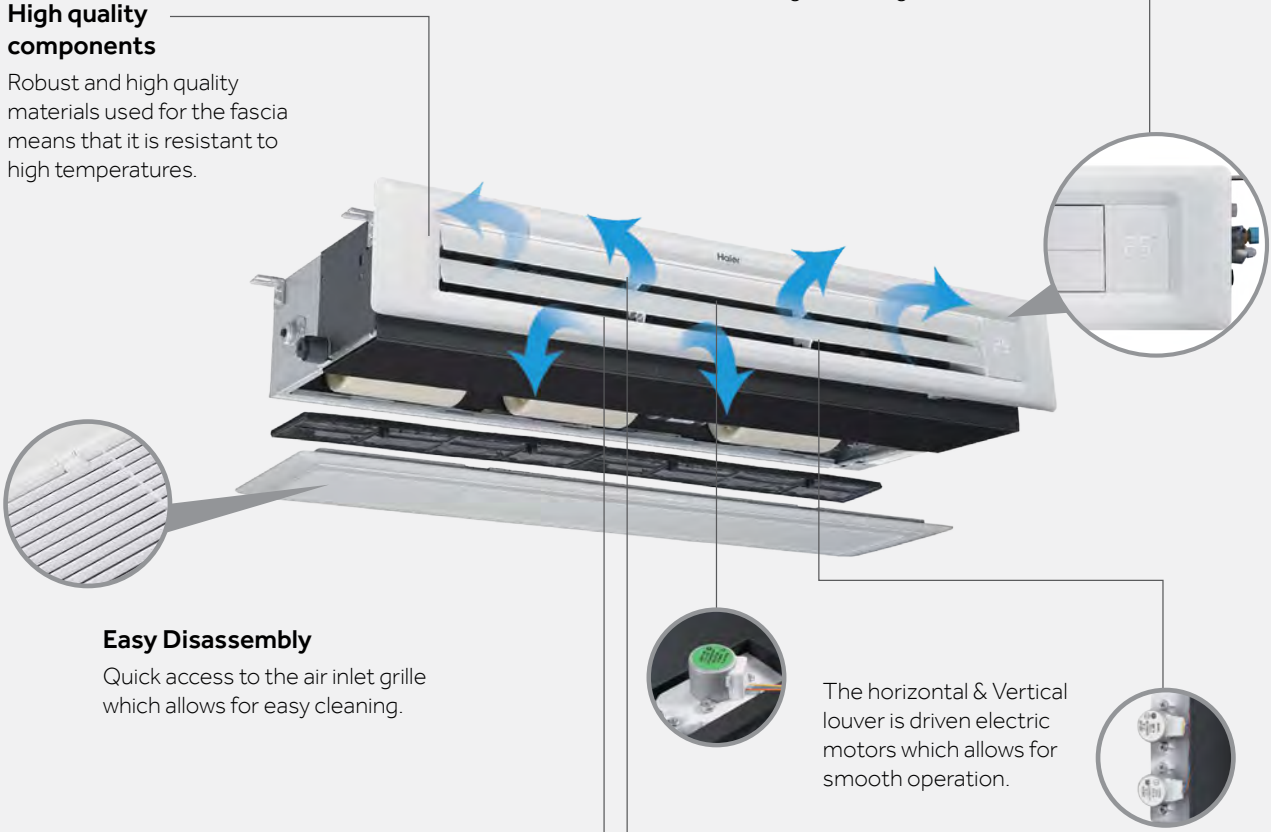



AD052MSERA(H)
AD072MSERA(H)
AD092MSERA(H)
AD122MSERA(H)
AD162MSERA(H)



AD182MSERA(H)
AD242MSERA(H)



Panel Kit **OPTIONAL**

New panel with built-in receiver for infrared remote control and temperature info display dimmable from controller

Air discharge grill equipped with vertical and horizontal 3D effect motorised fins

Air intake grill equipped with filter



Optional controller
HW-BA116ABK

Static pressure values
PA of the fan cannot
be modified using this
controller



Optional controller
HW-BA101ABT



Optional controller
YR-E17A



optional remote control YR-HRS01
(in combination with the RE-02 receiver,
not necessary if the panel kit is used)



Optional controller
YR-E16B

- Ideal for bedrooms, hotel rooms and quiet environments
- Extremely thin, only 185 mm
- Preparation for fresh air input
- Standard condensate drain pump
- Intake of lower or rear air by moving the panel as standard
- Silent operation
- Incorporates standard UVC ray generator to sterilize the air that flows through the unit
- Designed for free-mount installation without duct, with a standard prevalence of 0 PA. You can increase static pressure to 15 or 30 PA by using this unit with the flush wired controllers: HW-BA101ABT, YR-E17A, YR-E16B.
- Possibility of optional functional aesthetic control kit panel
- DC inverter fan motor
- 5 fan speeds only selectable with wired controller YR-E16B and YR-E17A

Model		AD052MSERA(H)	AD072MSERA(H)	AD092MSERA(H)	AD122MSERA(H)	AD162MSERA(H)	AD182MSERA(H)	AD242MSERA(H)
Capacity								
Cooling	kW	1,50	2,20	2,80	3,60	4,50	5,60	7,10
Heating	kW	1,70	2,50	3,20	4,00	5,00	6,30	8,00
Electrical Parameters								
Power supply	Ph-V/Hz	1/220~230/50/60						
Ventilation								
Air flow (H/m/l)	m ³ /h	430/370/310	480/420/360	480/420/360	550/430/370	600/540/460	800/690/580	930/850/750
Sound pressure level (H/m/l)	dB(A)	26/22/19	27/23/20	27/23/20	30/27/24	32/29/26	33/30/27	36/33/30
Sound power level (H/m/l)	dB(A)	40/36/33	41/37/34	41/37/34	44/41/38	46/43/40	47/44/41	50/47/43
Installation – Dimensions								
Unit Dimensions WxDxH	mm	850x420x185	850x420x185	850x420x185	850x420x185	850x420x185	1170x420x185	1170x420x185
Packaged unit dimensions WxDxH	mm	1045x540x270	1045x540x270	1045x540x270	1045x540x270	1045x540x270	1365x540x270	1365x540x270
Net weight / Gross weight	Kg	16,5/21,5	17,5/22,5	17,5/22,5	17,5/22,5	18,5/23,5	22,2/28,2	24,0/30,0
Ø Liquid side refrigerant pipe	mm	6,35 (1/4)	6,35 (1/4)	6,35 (1/4)	6,35 (1/4)	6,35 (1/4)	6,35 (1/4)	9,52 (3/8)
Ø Gas side refrigerant pipe	mm	9,52 (3/8)	9,52 (3/8)	9,52 (3/8)	12,70 (1/2)	12,70 (1/2)	12,70 (1/2)	15,88 (5/8)
Static pressure (Standard / Max)	Pa	0/15/30	0/15/30	0/15/30	0/15/30	0/15/30	0/15/30	0/15/30
Panel								
Model		P1B-890IA/D	P1B-890IA/D	P1B-890IA/D	P1B-890IA/D	P1B-890IA/D	P1B-1210IA/D	P1B-1210IA/D
Dimensions WxDxH (delivery deflector)	mm	890x190x100	890x190x100	890x190x100	890x190x100	890x190x100	1210x190x100	1210x190x100
Dimensions WxDxH (intake panel with filter)	mm	890x290,5x32,4	890x290,5x32,4	890x290,5x32,4	890x290,5x32,4	890x290,5x32,4	1210x290,5x32,4	1210x290,5x32,4
Packaging dimensions WxDxH	mm	938x335x220	938x335x220	938x335x220	938x335x220	938x335x220	1258x335x220	1258x335x220
Net weight / Gross weight	Kg	4,0/5,0	4,0/5,0	4,0/5,0	4,0/5,0	4,0/5,0	5,0/6,0	5,0/6,0



AD052MJERA(H)
AD072MJERA(H)
AD092MJERA(H)
AD122MJERA(H)
AD162MJERA(H)
AD182MJERA(H)
AD242MJERA(H)
AD282MJERA(H)
AD302MJERA(H)
AD382MJERA(H)
AD482MJERA(H)
AD542MJERA(H)



The inbuilt UV-C ray emitter module performs an effective and efficient air sterilization both on the unit's coil surface and the air that passes through. This module's performance has been certified by the independent laboratory Texcell.



Optional controller
HW-BA116ABK



Optional controller
HW-BA101ABT



Optional controller
YR-E17A



optional remote control YR-HRS01
(RE-02 remote control receiver)







Optional controller
YR-E16B

- Compact Ducted Medium Pressure
- Static pressure fan 20 / 200 PA.
- The standard static pressure is 20 PA.
- It is possible to increase the PA from 20 to 200 by only using wired controller models HW-BA101ABT, YR-E17A, YR-E16B .
- With all other controllers, the pressure remains fixed at 50 PA.
- Standard condensate drain pump
- Incorporates standard UVC ray generator to sterilize the air that flows through the unit

Model		AD052MJERA(H)	AD072MJERA(H)	AD092MJERA(H)	AD122MJERA(H)	AD162MJERA(H)	AD182MJERA(H)	AD242MJERA(H)	AD282MJERA(H)	AD302MJERA(H)	AD382MJERA(H)	AD482MJERA(H)	AD542MJERA(H)	
Capacity														
Cooling	kW	1,50	2,20	2,80	3,60	4,50	5,60	7,10	8,00	9,00	11,20	14,00	16,00	
Heating	kW	1,70	2,50	3,20	4,00	5,00	6,30	8,00	9,00	10,00	13,00	16,30	18,00	
Electrical Parameters														
Power supply	Ph/V/Hz	1/220-230/50/60												
Ventilation														
Air flow (H/M/L)	m ³ /h	515/ 440/390	545/ 470/390	545/ 470/390	570/ 495/420	700/ 625/550	915/ 765/640	1275/ 1050/875	1275/ 1050/875	1450/ 1200/1000	2000/ 1700/1400	2150/ 1750/1400	2350/ 1950/1600	
Sound pressure (H/M/L)	dB(A)	29/27/25	30/28/25	30/28/25	31/29/27	32/30/28	33/31/29	34/31/29	35/33/30	36/33/30	38/35/32	40/36/32	42/38/34	
Sound power (H/M/L)	dB(A)	41/39/37	42/40/37	42/40/37	43/41/39	44/42/40	45/43/41	46/43/41	47/45/42	48/45/42	50/47/44	52/48/44	54/50/46	
Installation – Dimensions														
Net dimensions (WxDxH)	mm	700x700x248					1100x700x248				1500x700x248			
Packaged unit dimensions (WxDxH)	mm	932x835x280					1332x835x280				1698x857x305			
Net/gross weight	Kg	27,0/32,0	27,0/32,0	27,0/32,0	27,0/32,0	28,5/33,5	36,8/43,4	36,8/43,4	36,8/43,4	39,4/45,4	48,3/56,5	51,3/59,5	51,3/59,5	
Ø Liquid pipe	mm (inch)	6,35 (1/4)	6,35 (1/4)	6,35 (1/4)	6,35 (1/4)	6,35 (1/4)	6,35 (1/4)	9,52 (3/8)	9,52 (3/8)	9,52 (3/8)	9,52 (3/8)	9,52 (3/8)	9,52 (3/8)	
Ø Gas pipe	mm (inch)	9,52 (3/8)	9,52 (3/8)	9,52 (3/8)	12,70 (1/2)	12,70 (1/2)	12,70 (1/2)	15,88 (5/8)	15,88 (5/8)	15,88 (5/8)	15,88 (5/8)	15,88 (5/8)	15,88 (5/8)	
Static pressure (Standard/Max.)	Pa	20/200	20/200	20/200	20/200	20/200	20/200	20/200	20/200	20/180	20/180	20/180	20/180	



AD722MTERAD
AD962MTERAD

 Optional controller HW-BA116ABK	 Optional controller HW-BA101ABT	 Optional controller YR-E17A	 optional remote control YR-HRS01 (RE-02 remote control receiver)	 Optional controller YR-E16B
---	---	---	--	---

- Flexible and simple ductwork
- Simple maintenance
- Static pressure varies from 100 to 300 Pa using included booster cable.
- Not equipped with condensate drain pump
- 3 speeds + booster

Model		AD722MTERAD	AD962MTERAD
Capacity			
Cooling	kW	22,60	28,00
Heating	kW	25,20	31,50
Electrical Parameters			
Power supply	Ph-V/Hz	1/220-230/50/60	1/220-230/50/60
Ventilation			
Air flow (H/m/l)	m ³ /h	4000/3600/3200	4500/3700/3300
Sound pressure level (H/L)	dB(A)	50/46	51/47
Sound power level (H/L)	dB(A)	64/60	65/61
Installation – Dimensions			
Unit Dimensions WxDxH	mm	1438x748x495	1438x748x495
Packaged unit dimensions WxDxH	mm	1558x896x652	1558x896x652
Net weight / Gross weight	Kg	86/102	86/102
Ø Liquid side refrigerant pipe	mm	12,70 (1/2)	12,70 (1/2)
Ø Gas side refrigerant pipe	mm	22,22 (7/8)	22,22 (7/8)
Static pressure (Standard / Max)	Pa	100/300	100/300



AD072MQERA
AD092MQERA
AD122MQERA
AD152MQERA
AD182MQERA
AD242MQERA
AD302MQERA

*Until stocks last.



Optional controller
HW-BA116ABK



Optional controller
HW-BA101ABT



Optional controller
YR-E17A

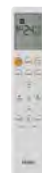

optional remote control YR-HRS01
(RE-02 remote control receiver)



Optional controller
YR-E16B

- Automatic system to maintain nominal air flow, offsetting duct losses of up to 200 PA
- Useful Static pressure up to 200 Pa with automatic selection.
- Maximum flexibility for the construction of air distribution ducts.
- Standard condensate drain pump
- DC inverter fan motor
- 5 fan speeds only selectable with wired controller YR-E16B and YR-E17A.

Model		AD072MQERA	AD092MQERA	AD122MQERA	AD152MQERA	AD182MQERA	AD242MQERA	AD302MQERA
Capacity								
Cooling	kW	2,20	2,80	3,60	4,50	5,60	7,10	9,0
Heating	kW	2,50	3,20	4,00	5,00	6,30	8,00	10,0
Electrical Parameters								
Power supply	Ph-V/Hz	1/220-230/50/60	1/220-230/50/60	1/220-230/50/60	1/220-230/50/60	1/220-230/50/60	1/220-230/50/60	1/220-230/50/60
Ventilation								
Air flow (H/M/L)	m ³ /h	500/410/360	600/510/450	700/580/500	780/680/600	900/780/600	1100/1020/920	1500/1320/1220
Sound pressure (H/M/L)	dB(A)	30/25/23	30/25/23	32/29/26	32/29/26	32/29/26	33/29/25	33/29/25
Installation – Dimensions								
Net dimensions (WxDxH)	mm	750x635x280	750x635x280	750x635x280	750x635x280	750x635x280	950x635x280	950x635x280
Packaged unit dimensions (WxDxH)	mm	980x740x335	980x740x335	980x740x335	980x740x335	980x740x335	1180x740x335	1180x740x335
Net/gross weight	Kg	29,0/35,0	29,0/35,0	29,0/35,0	29,0/35,0	29,0/35,0	34,0/41,0	34,0/41,0
Ø Liquid pipe	mm (inch)	6,35 (1/4)	6,35 (1/4)	6,35 (1/4)	6,35 (1/4)	6,35 (1/4)	9,52 (3/8)	9,52 (3/8)
Ø Gas pipe	mm (inch)	9,52 (3/8)	9,52 (3/8)	12,70 (1/2)	12,70 (1/2)	12,70 (1/2)	15,88 (5/8)	15,88 (5/8)
Static pressure (Standard/Max.)	Pa	0/200	0/200	0/200	0/200	0/200	50/200	0/200



AE072MLERA
 AE092MLERA
 AE122MLERA
 AE162MLERA
 AE182MLERA
 AE242MLERA

Optional controller HW-BA116ABK	Optional controller HW-BA101ABT	Optional controller YR-E17A	optional remote control YR-HRS01 (RE-02 remote control receiver)	Optional controller YR-E16B

- Compact and thin, only 220 mm depth
- Ideal for installation under window
- High-efficiency standard filter

Model		AE072MLERA	AE092MLERA	AE122MLERA	AE162MLERA	AE182MLERA	AE242MLERA
Capacity							
Cooling	kW	2,20	2,80	3,60	4,50	5,60	7,10
Heating	kW	2,50	3,20	4,00	5,00	6,30	8,00
Electrical Parameters							
Power supply	Ph-V/Hz	1/220-230/50/60	1/220-230/50/60	1/220-230/50/60	1/220-230/50/60	1/220-230/50/60	1/220-230/50/60
Ventilation							
Air flow (H/M/L)	m ³ /h	750/650/550	750/650/550	750/650/550	950/830/720	950/830/720	950/830/720
Sound pressure (H/M/L)	dB(A)	38/35/33	38/35/33	40/37/35	40/37/35	42/39/36	42/39/36
Sound power level (H/M/L)	dB(A)	51/48/46	51/48/46	53/50/48	53/50/48	55/52/49	55/52/49
Installation – Dimensions							
Net dimensions (WxDxH)	mm	1116x221x624	1116x221x624	1116x221x624	1116x221x624	1116x221x624	1116x221x624
Packaged unit dimensions WxDxH	mm	1425x315x685	1425x315x685	1425x315x685	1425x315x685	1425x315x685	1425x315x685
Net weight / Gross weight	Kg	29,0/37,0	29,0/37,0	29,0/37,0	31,0/39,0	31,0/39,0	31,0/39,0
Ø Liquid pipe	mm (inch)	6,35 (1/4)	6,35 (1/4)	6,35 (1/4)	6,35 (1/4)	6,35 (1/4)	9,52 (3/8)
Ø Gas pipe	mm (inch)	9,52 (3/8)	9,52 (3/8)	12,70 (1/2)	12,70 (1/2)	12,70 (1/2)	15,88 (5/8)
Static pressure (Standard/Max.)	Pa	0/30	0/30	0/30	0/30	0/30	0/30



AF052MBERA
AF072MBERA
AF092MBERA
AF122MBERA
AF162MBERA
AF182MBERA

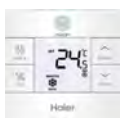

Optional controller
HW-BA116ABK

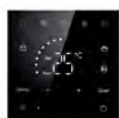

Optional controller
HW-BA101ABT



Optional controller
YR-E17A

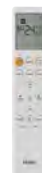

Optional remote control
YR-HRS01



Optional controller
YR-E16B

- Double air delivery, upper and lower.
In heating mode: both outputs are enabled, to spread hot air at floor level preventing the "cold feet" effect typical of only higher deliveries. By acting on the on-board selector it is possible to inhibit the lower output in heating mode.
In cooling mode: The unit works only with the top delivery, the lower output automatically closes.
- Compact and elegant design
- Silent operation
- DC inverter fan motor
- 5 fan speeds only selectable with wired controller YR-E16B and YR-E17A.

Model		AF052MBERA	AF072MBERA	AF092MBERA	AF122MBERA	AF162MBERA	AF182MBERA
Capacity							
Cooling	kW	1,50	2,20	2,80	3,60	4,50	5,00
Heating	kW	1,70	2,60	3,20	4,00	5,00	5,50
Electrical Parameters							
Power supply	Ph-V/Hz	1/220-230/50/60	1/220-230/50/60	1/220-230/50/60	1/220-230/50/60	1/220-230/50/60	1/220-230/50/60
Ventilation							
Air flow (H/M/L)	m ³ /h	540/460/390/310/270	540/460/390/310/270	540/460/390/310/270	580/500/420/350/270	620/540/460/390/270	620/540/460/390/270
Sound pressure (H/M/L)	dB(A)	45/42/38/33/30	45/42/38/33/30	45/42/38/33/30	47/44/40/36/30	48/45/42/38/30	48/45/42/38/30
Sound power (H/M/L)	dB(A)	58/55/52/48/45	58/55/52/48/45	58/55/52/48/45	60/57/54/51/47	61/58/55/42/48	61/58/55/42/48
Installation – Dimensions							
Net dimensions (WxDxH)	mm	700x210x600	700x210x600	700x210x600	700x210x600	700x210x600	700x210x600
Packaged unit dimensions (WxDxH)	mm	783x303x695	783x303x695	783x303x695	783x303x695	783x303x695	783x303x695
Net/gross weight	Kg	15,2/18,7	15,2/18,7	15,2/18,7	15,2/18,7	15,2/18,7	15,2/18,7
Ø Liquid pipe	mm (inch)	6,35 (1/4)	6,35 (1/4)	6,35 (1/4)	6,35 (1/4)	6,35 (1/4)	6,35 (1/4)
Ø Gas pipe	mm (inch)	12,70 (1/2)	12,70 (1/2)	12,70 (1/2)	12,70 (1/2)	12,70 (1/2)	12,70 (1/2)

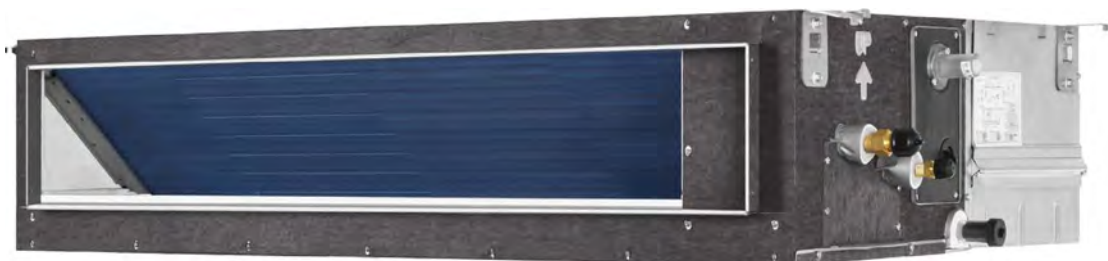

AD482MJERAF
AD722MTERAF
AD962MTERAF

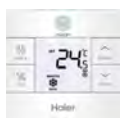

Optional controller
HW-BA116ABK



Optional controller
HW-BA101ABT

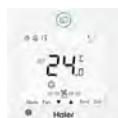

Optional controller
YR-E17A



optional remote control YR-HRS01
(RE-02 remote control receiver)



Optional controller
YR-E16B

- Static pressure selection (16 speed for AD722/962MTERAF and 10 speed for AD482MTERAF)
- Can be installed together with other indoor units on the same refrigerating circuit, to pre-treat the outdoor air before sending it to indoor units or in the environment.
- Please notice that the nominal potential in heating is always lower than that of cooling.
- Integrated flow switch.

Model		AD482MJERAF	AD722MTERAF	AD962MTERAF
Capacity				
Cooling	kW	14,00	22,60	28,00
Heating	kW	8,90	15,20	17,80
Electrical Parameters				
Power supply	Ph/V/Hz	1/220-230/50/60	1/220-230/50/60	1/220-230/50/60
Ventilation				
Air flow (H/M/L)	m ³ /h	1600/1460/1070	4000/3500/3000	4500/4000/3600
Sound pressure (H/M/L)	dB(A)	48/47/42	50/47/44	51/48/45
Sound power (H/M/L)	dB(A)	61/60/56	68/65/60	68/66/62
Installation – Dimensions				
Net dimensions (WxDxH)	mm	1500x700x248	1512x856x502	11512x856x502
Packaged unit dimensions (WxDxH)	mm	1718x848x345	1558x896x612	1558x896x612
Net/gross weight	Kg	43,6/50,4	102,0/116,0	102,0/116,0
Ø Liquid pipe	mm (inch)	9,52 (3/8)	12,70 (1/2)	12,70 (1/2)
Ø Gas pipe	mm (inch)	15,88 (5/8)	22,22 (7/8)	22,22 (7/8)
Static pressure (Standard/Max.)	Pa	100/200	100/250	100/250

MRV HYDROBOX – FEATURES

LOW OPERATING COST

By using free renewable energy from the outside air as heat source, it is more energy efficient and environmentally friendlier than oil and gas boilers. The operating cost is low due to high efficiency heat pump and heat recovery technology.

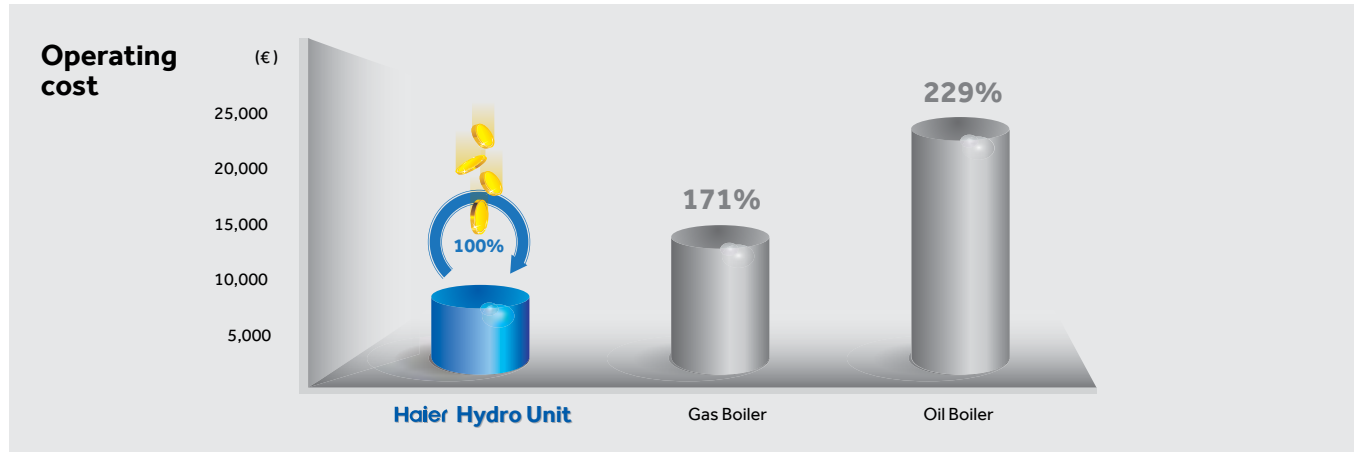

COMFORT

The hydro box unit has a heating capacity of up to 28kW per module which can be used in combination for larger systems. The leaving water temperature ranges from 5°C to 55°C, this provides desirable climate comfort to users. Connectible to MRV 5-H, MRV 5-RC and MRV SII.



MRV HYDROBOX – FEATURES

MULTIPLE HEATING AND COOLING SOLUTIONS CAN BE SELECTED TO PROVIDE:

1. ATA (AIR-TO-AIR) AND ATW (AIR-TO-WATER)

In the summer, ATA cooling and DHW (Domestic hot water) can be used. The heat pump outdoor and hydro unit can provide hot water to heat up water stored in the DHW tank when the MRV indoor units is not operating. The outdoor heat recovery can supply cooling and the hydro unit can provide a hot water supply at the same time.

In winter, ATA heating or hot water heating can be selected to warm the rooms, and DHW can still be heated up at the same time.

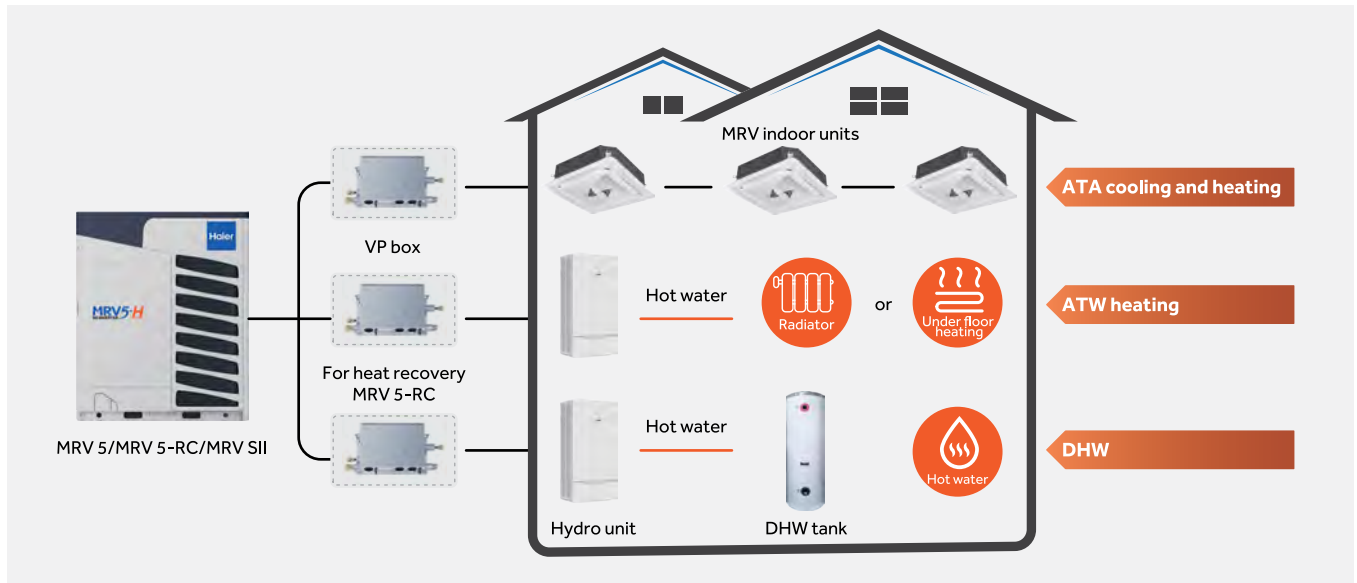

2. ONLY ATW (AIR-TO-WATER)

In summer, the outdoor heat pump and hydro unit can provide hot water to heat up water stored in the DHW tank when the fan coils or AHU cooling is not operated. In spring and autumn the outdoor heat recovery and hydro unit can provide hot water when the fan coils or AHU cooling is operating.

In winter, fan coils provide heating to warm the rooms, while the DHW is heated up at the same time.

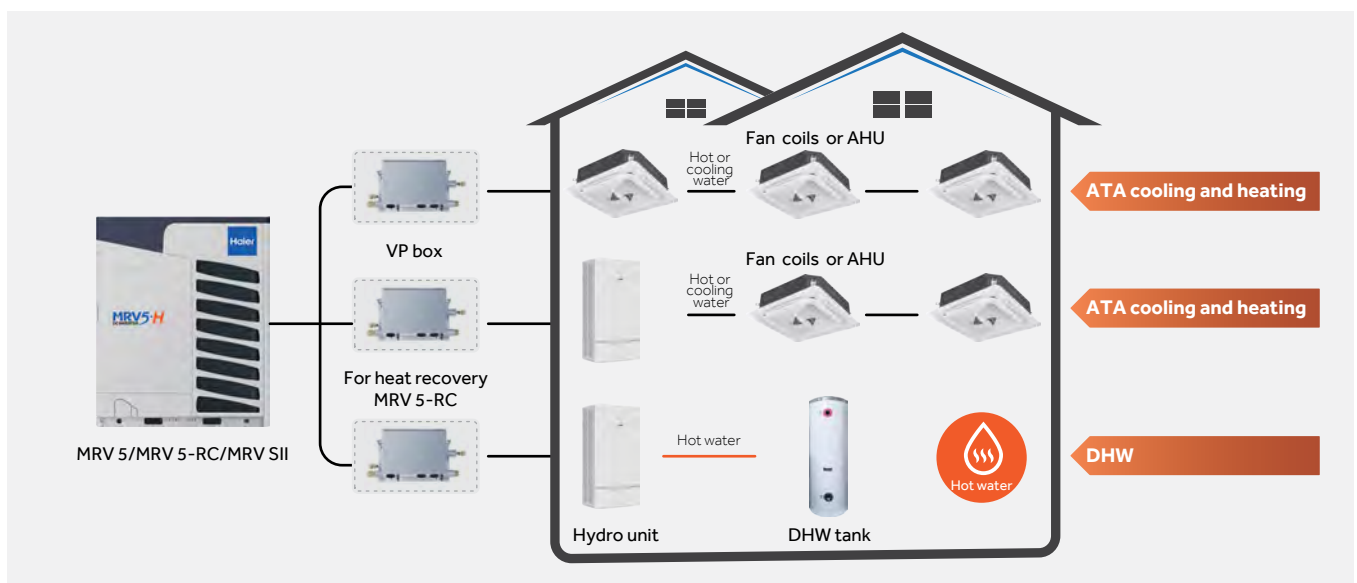

NEW MRV HYDROBOX



HU092WVLNA
HU162WVLNA
HU312WVLNA

9 / 16 / 31kW

Model			HU092WVLNA	HU162WVLNA	HU312WVLNA
Nominal capacity	Cooling (1)	kW	7	14	28
	Heating (2)	kW	9	16	31
Dimensions Unit	H x W x D	mm	850 × 480 × 310	850 × 480 × 310	850 × 480 × 310
Weight Unit		Kg	56	56	52
Installation place	Indoor/outdoor		Indoor	Indoor	Indoor
Combination ratio	Only hydro module	%	50-100%	50-100%	50-100%
	Hydro box+IDUs	%	50-130%	50-130%	50-130%
Cooling Ambient	Min. - Max.	°CDB	10-43	10-43	10-43
Cooling Water side	Min. - Max.	°C	5-20	5-20	5-20
Heating Ambient	Min. - Max.	°C	-20-24	-20-24	-20-24
Water side	Min. - Max.	°C	20-50	20-50	20-50
Sound pressure level	Cooling/Heating	dB(A)	29/ 32	29/32	29/32
Sound power level		dB(A)	42	46	48
Water flow rate	Min-Standard	L/min	18/26	32/46	63/90
Water circuit Piping diameter	Inlet	inch "	1	1	1-1/4
	Outlet	inch "	1	1	1-1/4
Refrigerant Type			R410A	R410A	R410A
Gas side - connection type		mm	15,88 (5/8)	15,88 (5/8)	19,05 (3/4)
Liquid side - connection type		mm	9,52 (3/8)	9,52 (3/8)	9,52 (3/8)
Power supply		Ph / Hz / V	1/ 50/ 220-240	1/ 50/ 220-240	1/ 50/ 220-240
ODU compatibility	MRV 5, MRV 5-RC, MRV 5-H, MRV S 8-10-12HP				

(1) Tamb 35°C - LWE 18°C (DT=5°C)

(2) DB/WB 7°C/6°C - LWC 35°C (DT=5°C)

NEW MRV HYDROBOX

MRV HYDROBOX

HU092WVLNA HU162WVLNA HU312WVLNA

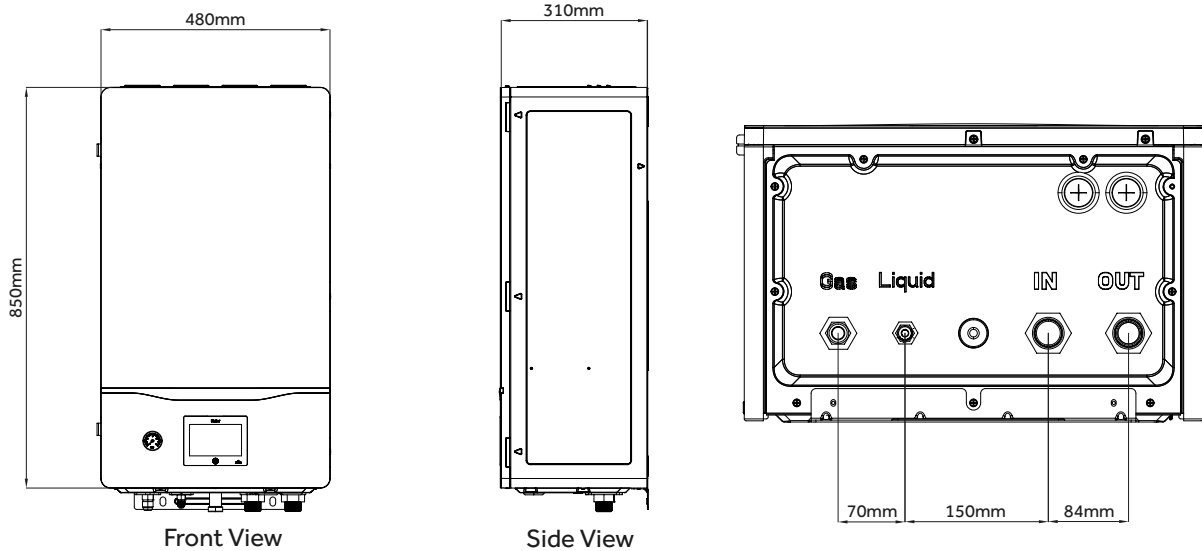

MRV INDOOR UNITS CASSETTE SMART FLOW

AB072MRERA AB092MRERA AB122MRERA AB162MRERA AB182MRERA AB242MRERA
AB282MRERA AB302MRERA AB382MRERA AB482MRERA AB602MRERA

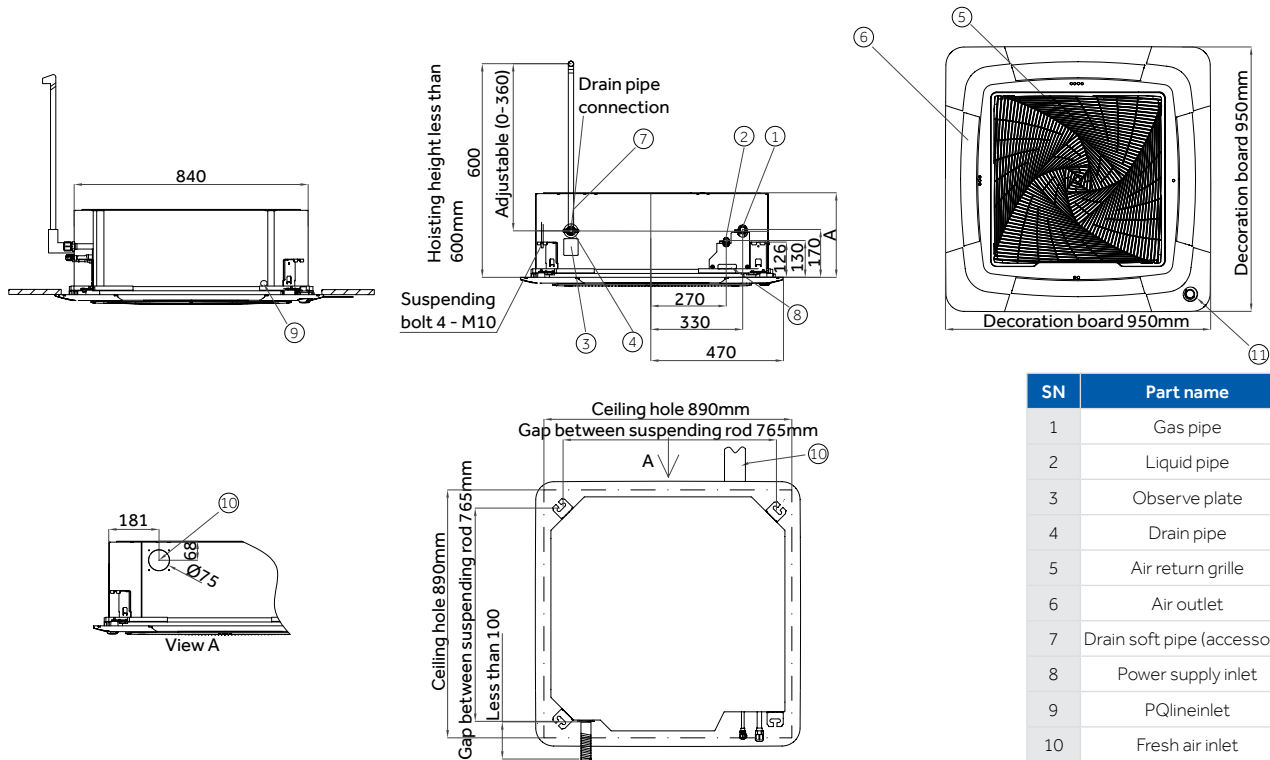

SN	Part name
1	Gas pipe
2	Liquid pipe
3	Observe plate
4	Drain pipe
5	Air return grille
6	Air outlet
7	Drain soft pipe (accessory)
8	Power supply inlet
9	PQlineinlet
10	Fresh air inlet
11	Move eye (optional)

MRV INDOOR UNIT 4-WAY CASSETTE 60X60

AB052MCERA(M) AB072MCERA(M) AB092MCERA(M) AB122MCERA(M) AB162MCERA(M) AB182MCERA(M)

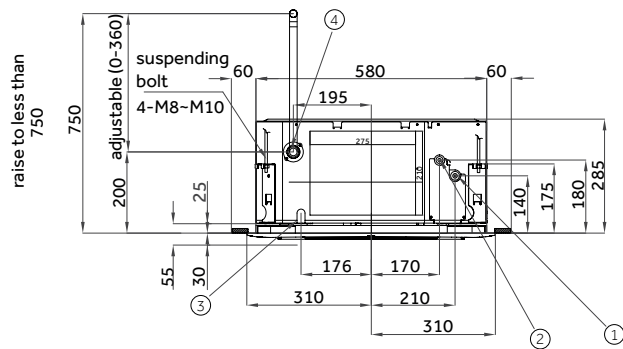
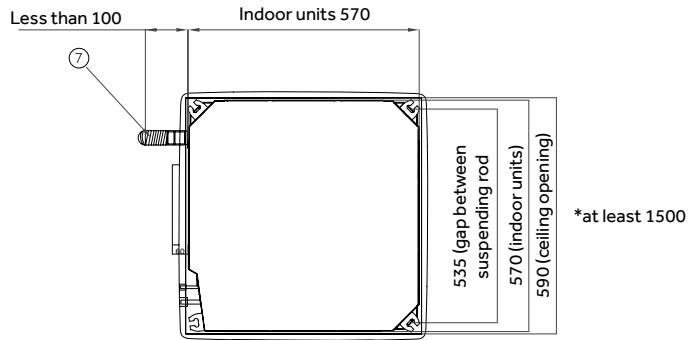
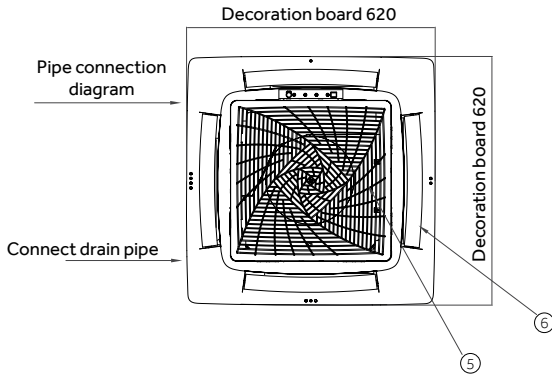

SN	Part name
1	Connection port of gas pipe
2	Connection liquid pipe
3	Wiring connection port of motor/pumping motor
4	Connect drain pipe
5	Inlet grill
6	Outlet grill
7	Drain hose (accessory)

MRV INDOOR UNIT WALL MOUNTED

AS052MNERAB AS072MNERAB AS092MNERAB AS122MNERAB
AS052MNERAC AS072MNERAC AS092MNERAC AS122MNERAC

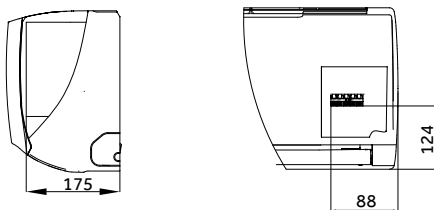
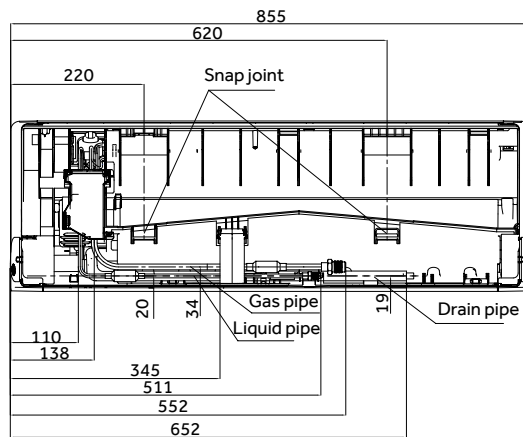
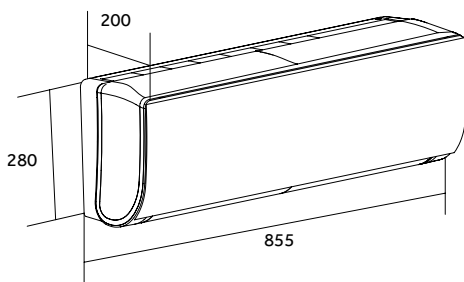

EXTERNAL EEV VALVE

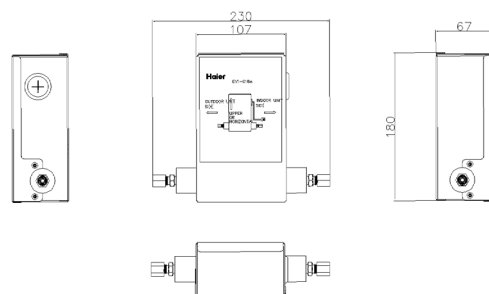

MRV INDOOR UNIT WALL MOUNTED

AS162MNERA AS182MNERA AS242MNERA
AS162MNERAC AS182MNERAC AS242MNERAC

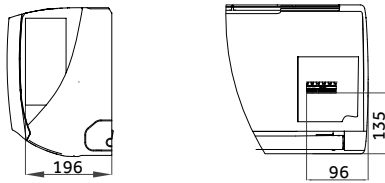
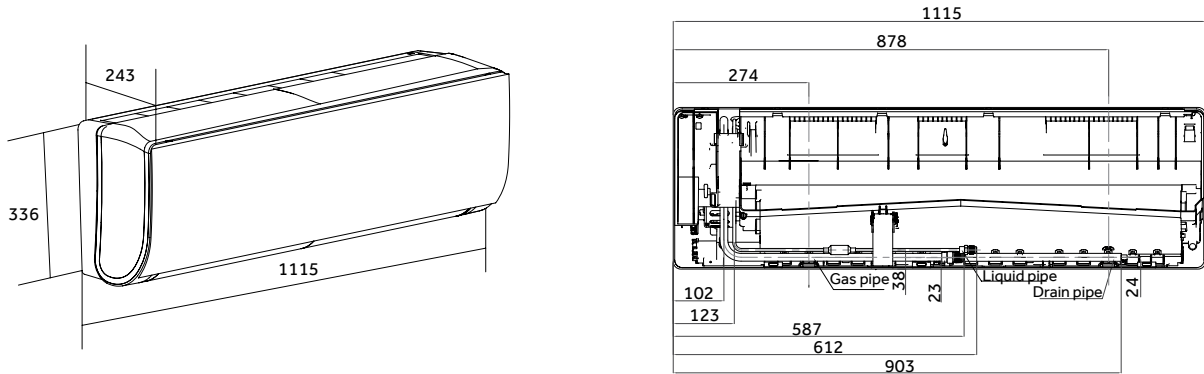

EXTERNAL EEV VALVE

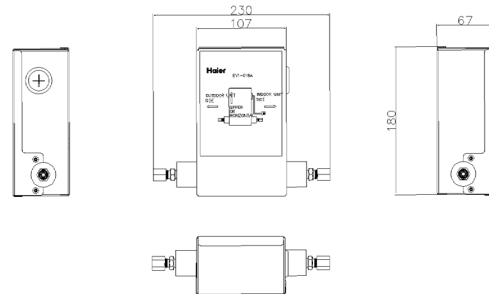

MRV INDOOR UNIT WALL MOUNTED

AS282MNERA AS302MNERA
AS282MNERAC AS302MNERAC

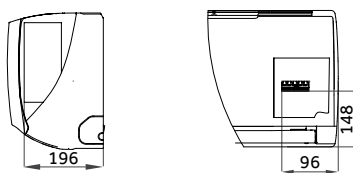
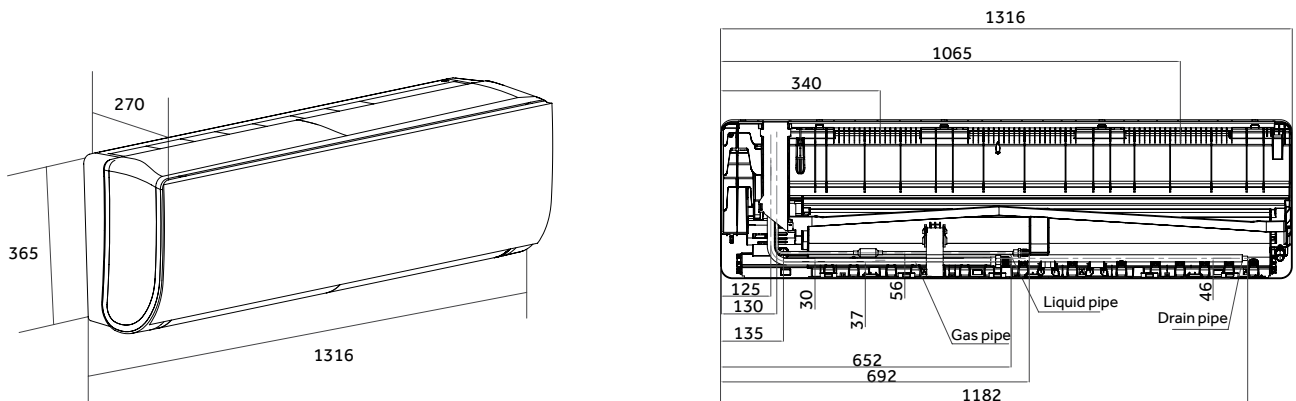

EXTERNAL EEV VALVE

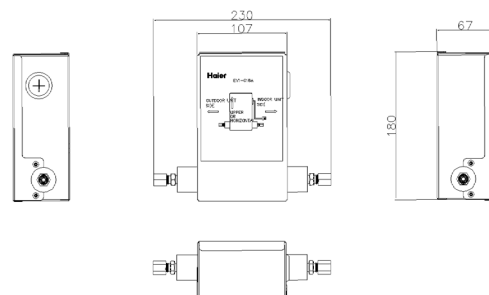

MRV INDOOR UNIT 1-WAY CASSETTE

AB052MAERA AB072MAERA AB092MAERA AB122MAERA

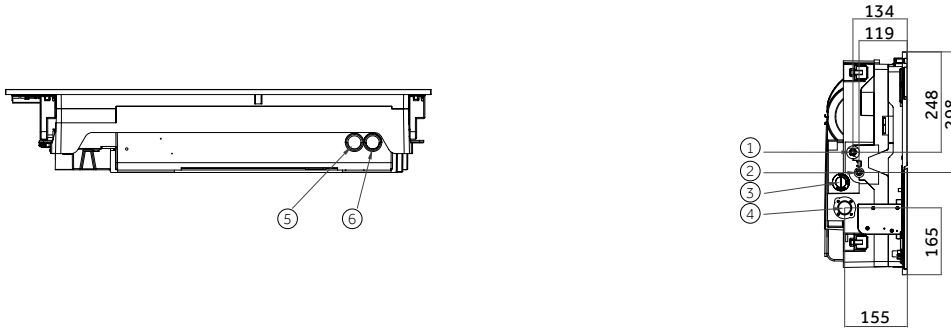

SN	Part name
1	Gas pipe
2	Liquid pipe
3	Water filling hole
4	Drain pipe
5	Power supply
6	Communication wire

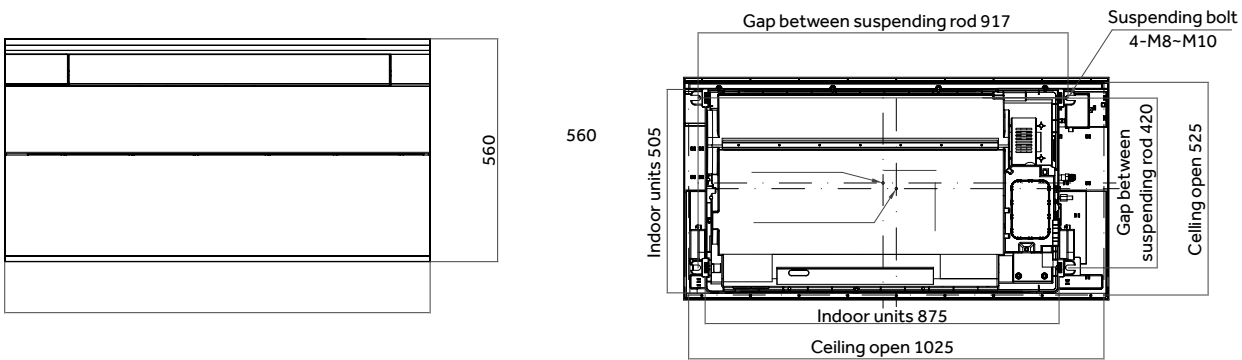

MRV INDOOR UNIT 2-WAY CASSETTE

AB072MBERA AB092MBERA AB122MBERA AB162MBERA AB182MBERA

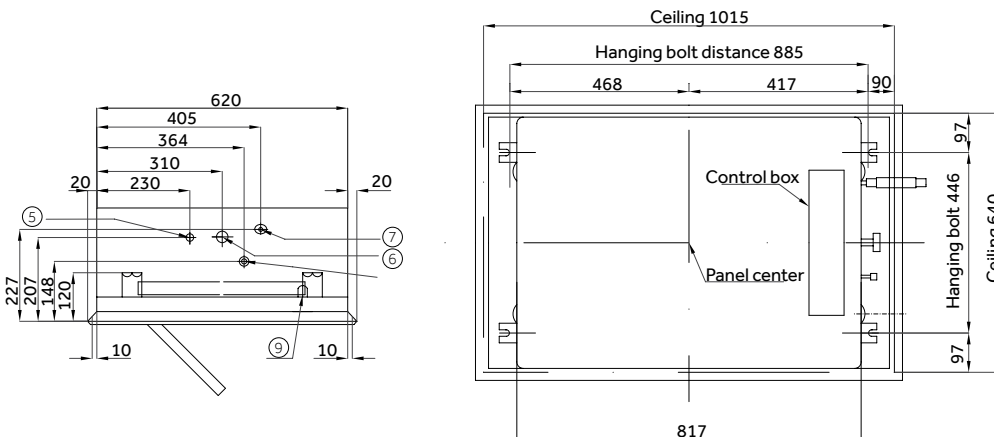
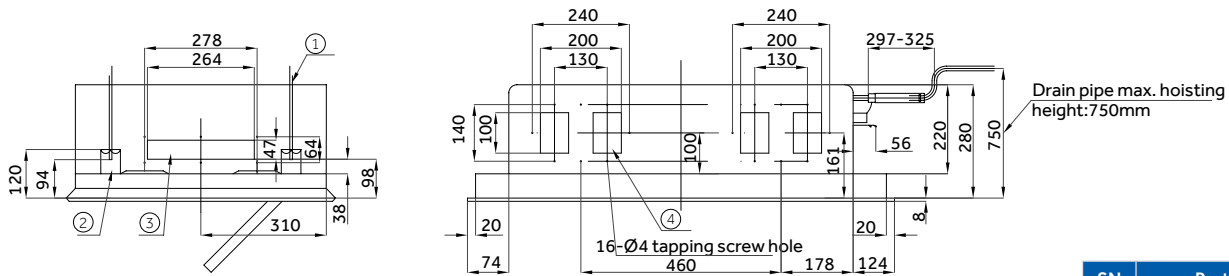

SN	Part name
1	Hanging bolt
2	Pothead
3	Fresh air entrance
4	Exhaust outlet: 4
5	Liquid pipe connect hole
6	Gas pipe connect hole
7	Drain pipe connect hole
8	Natural drain
9	Power line entrance

CONVERTIBLE

AC092MDERA AC122MDERA AC162MDERA AC182MDERA

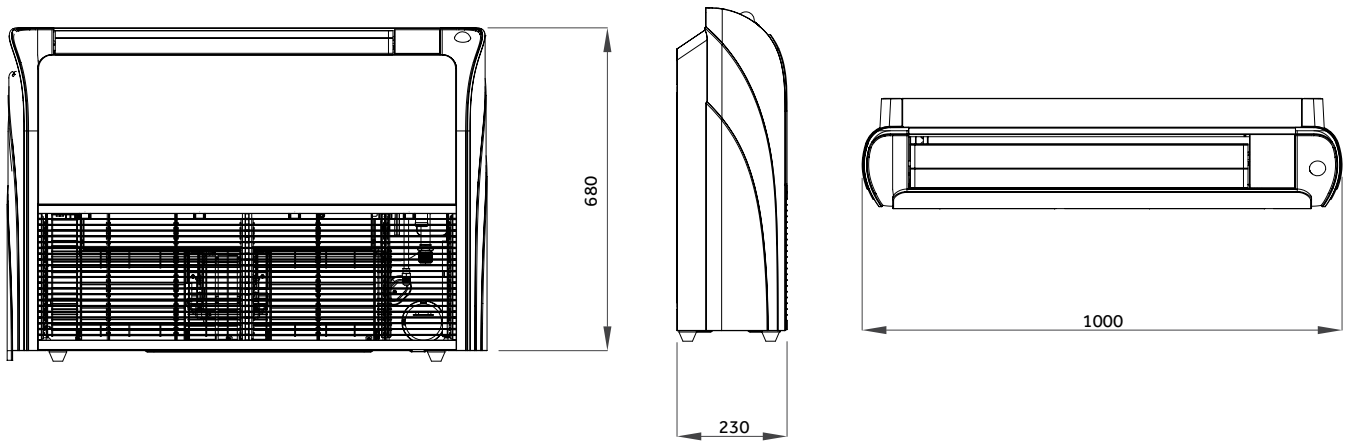

CONVERTIBLE

AC242MDERA AC282MDERA AC302MDERA

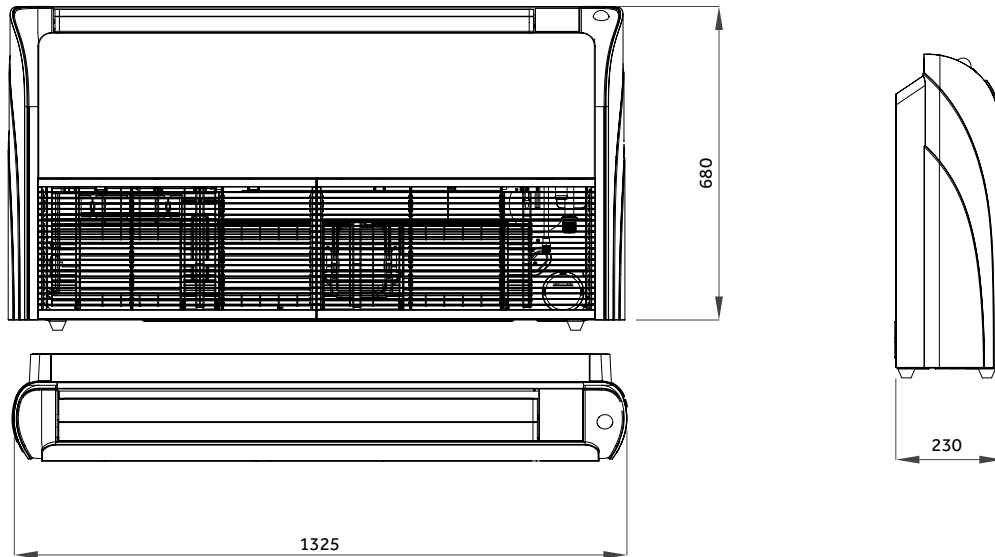

CONVERTIBLE

AC382MDERA AC482MDERA

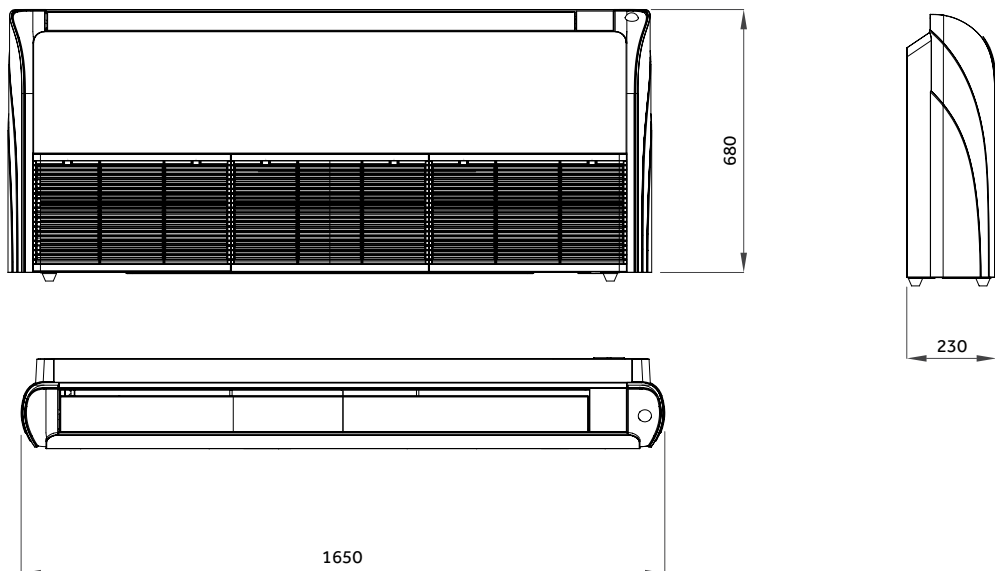

MRV INDOOR UNIT SLIM DUCT LOW PRESSURE

AD052MSERA(H) AD072MSERA(H) AD092MSERA(H) AD122MSERA(H) AD162MSERA(H)

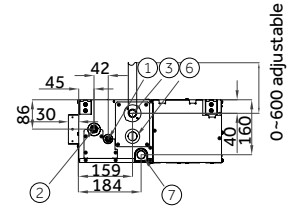
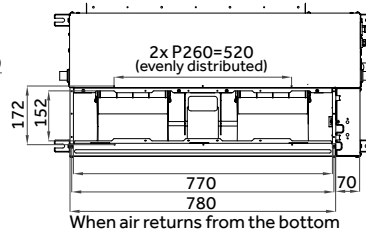
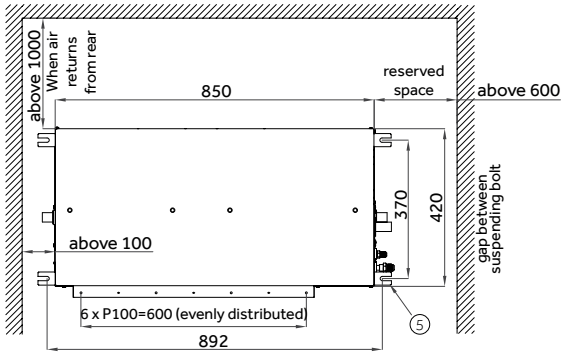

0-600 adjustable

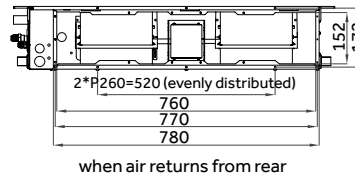
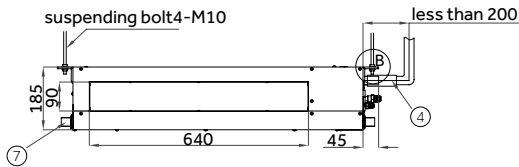

SN	Part name
1	Liquid pipe connection
2	Gas pipe connection
3	Drain hose the pump
4	Drain hose (accessory)
5	Suspending point
6	Checking hole
7	Water drainage outley

MRV INDOOR UNIT SLIM DUCT LOW PRESSURE

AD182MSERA(H) AD242MSERA(H)

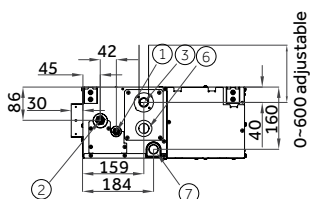
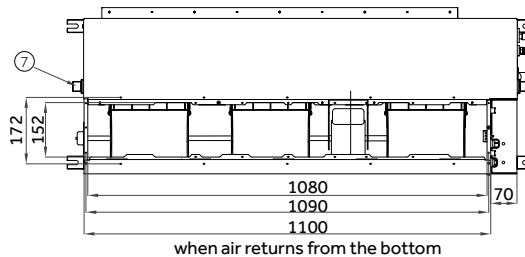
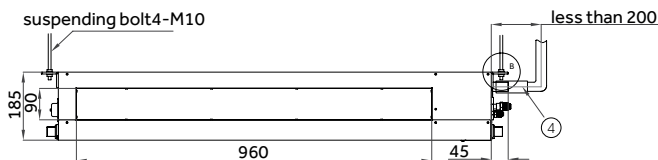
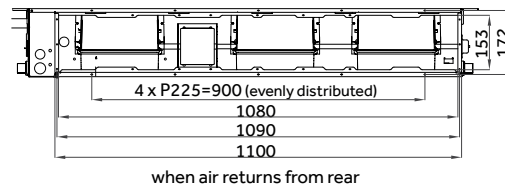
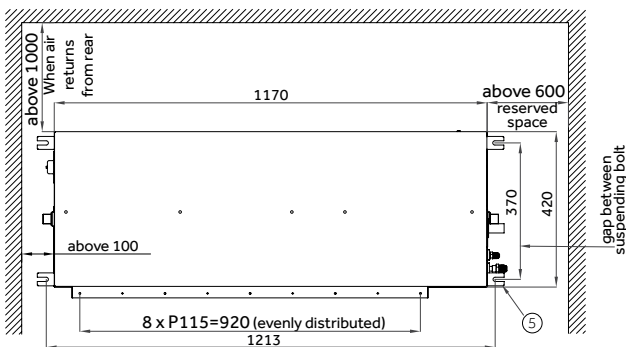

0-600 adjustable

SN	Part name
1	Liquid pipe connection
2	Gas pipe connection
3	Drain hose the pump
4	Drain hose (accessory)
5	Suspending point
6	Checking hole
7	Water drainage outley

MRV INDOOR UNIT DUCTED MEDIUM PRESSURE

AD052MJERA(H) AD072MJERA(H) AD092MJERA(H) AD122MJERA(H) AD162MJERA(H)

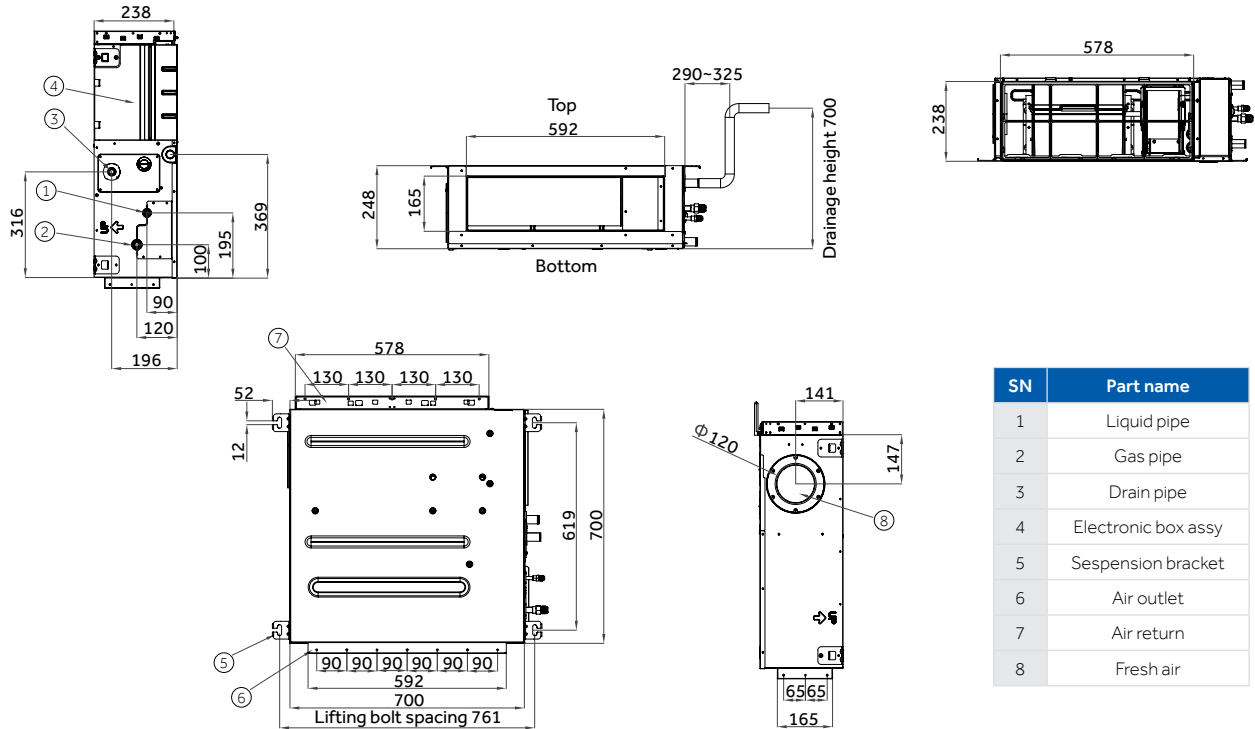

MRV INDOOR UNIT DUCTED MEDIUM PRESSURE

AD182MJERA(H) AD242MJERA(H) AD282MJERA(H) AD302MJERA(H)

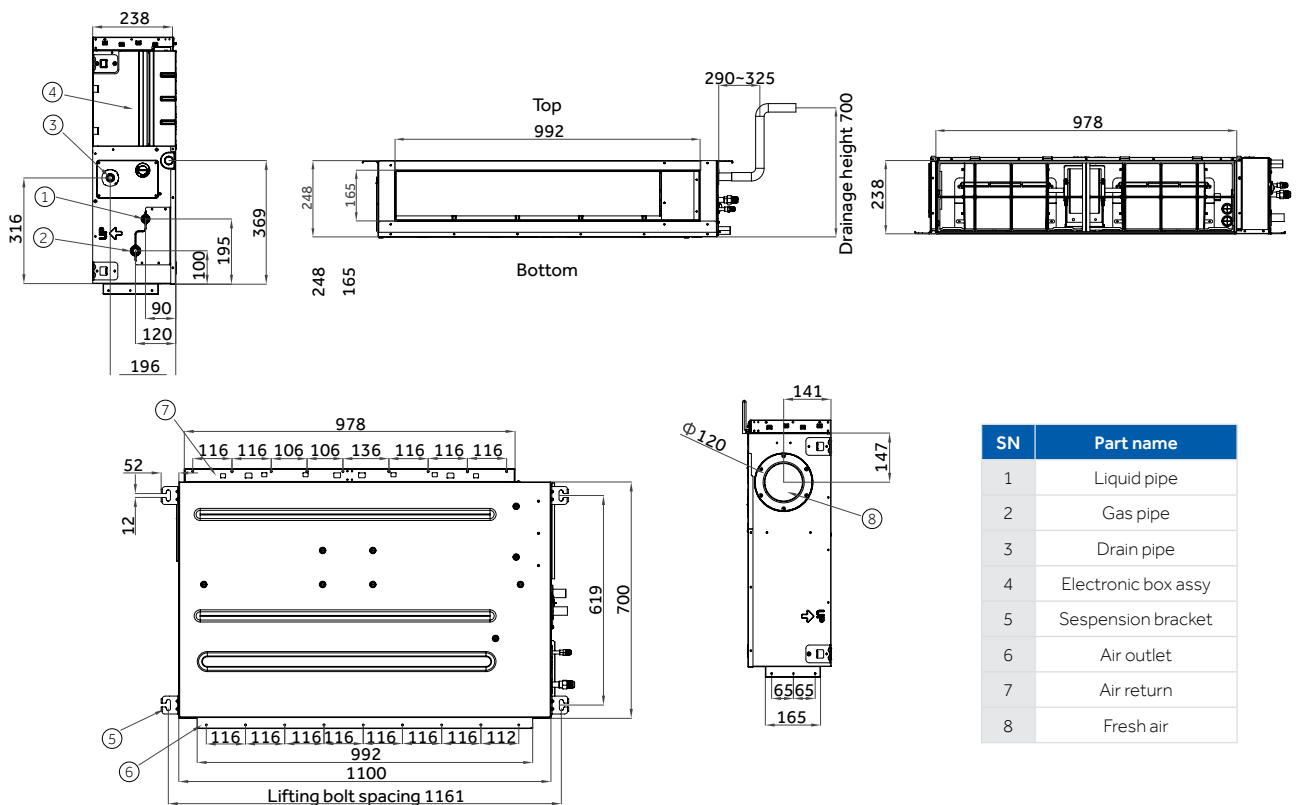

The data in this catalogue is purely indicative as the data may vary. Please be advised to check the accuracy of the data with the supplier before purchasing products.

MRV INDOOR UNIT DUCTED MEDIUM PRESSURE

AD382MJERA(H) AD482MJERA(H) AD542MJERA(H)

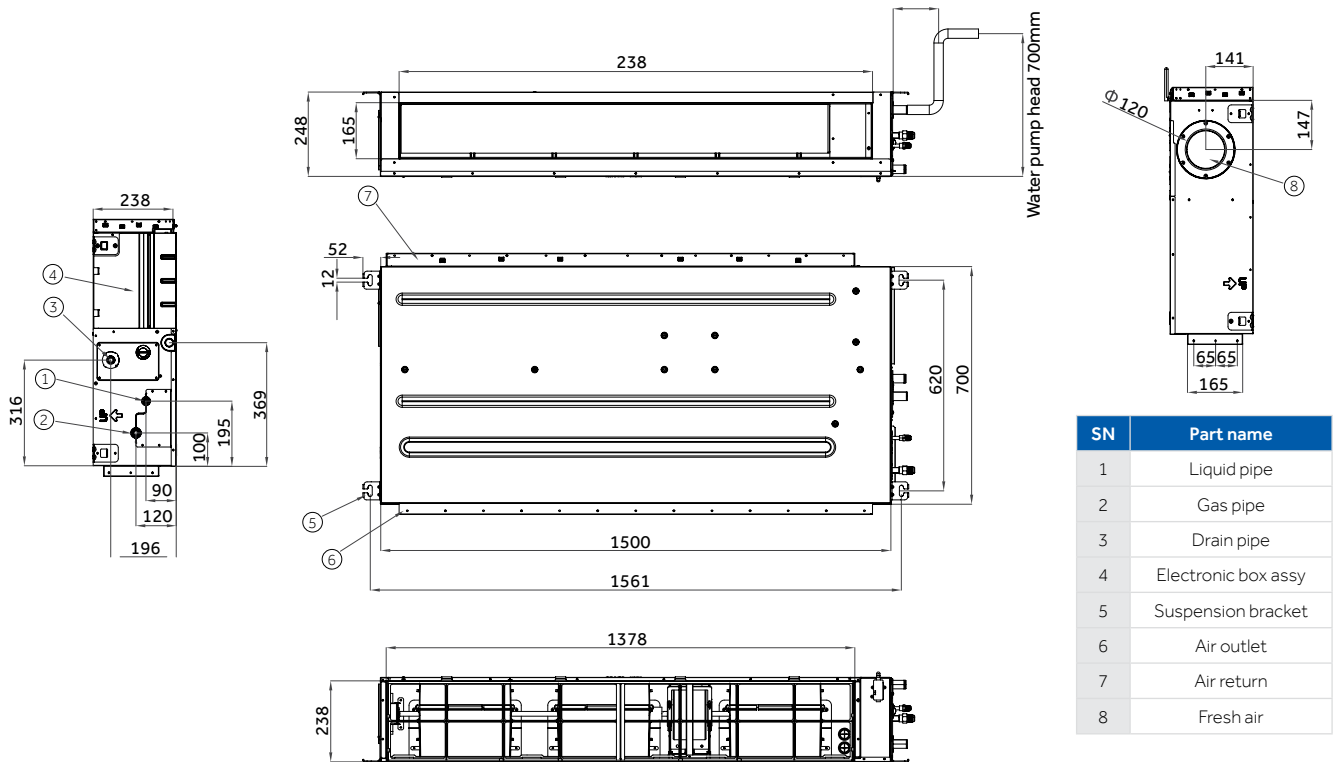

MRV INDOOR UNIT DUCTED HIGH PRESSURE

AD962MTERAD AD722MTERAD

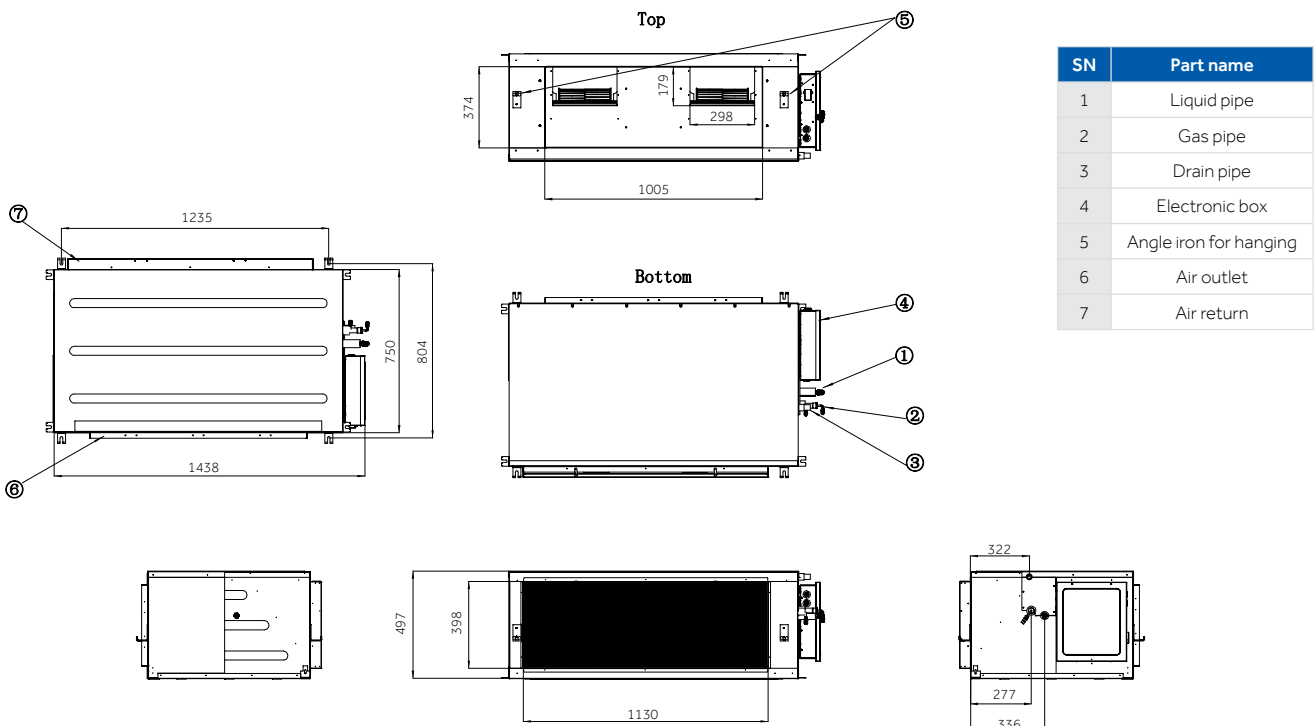

MRV INDOOR UNIT DUCTED - FIXED FLOW

AD072MQERA AD092MQERA AD122MQERA AD152MQERA AD182MQERA

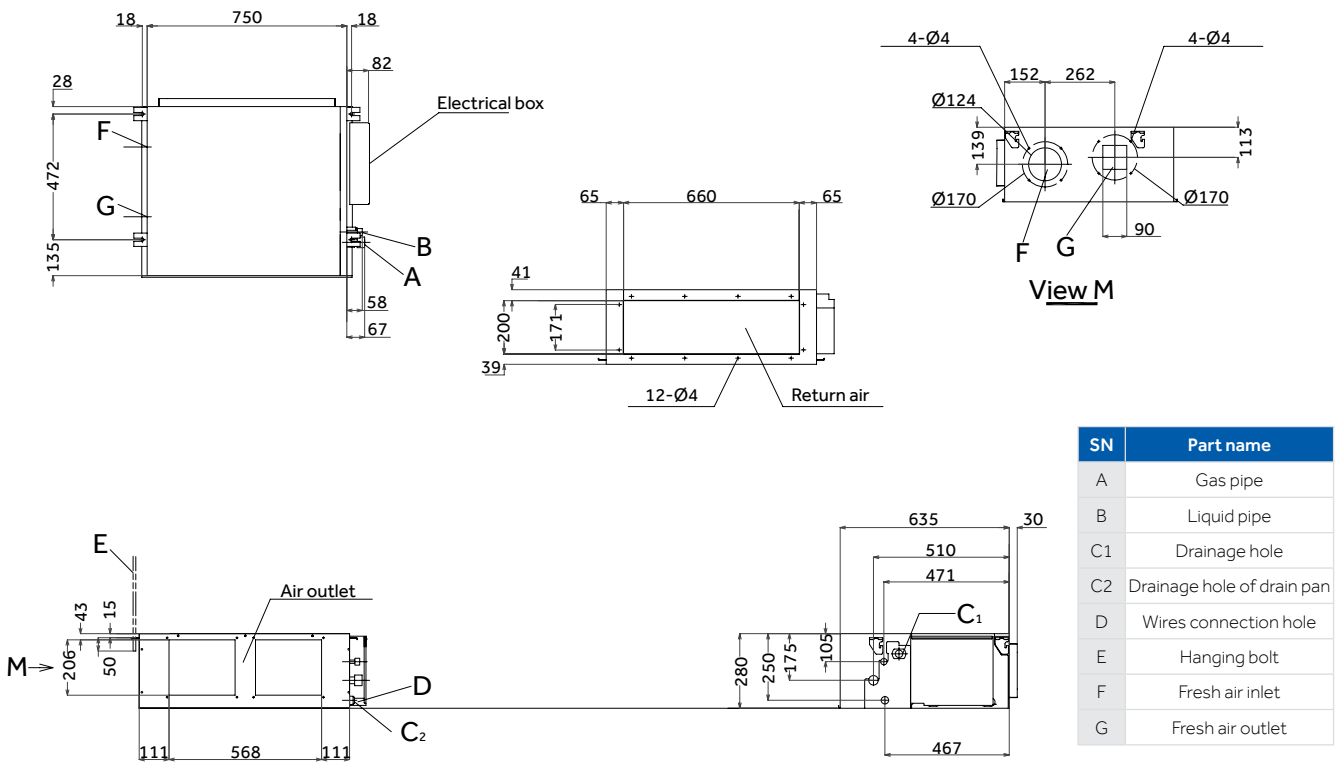

SN	Part name
A	Gas pipe
B	Liquid pipe
C1	Drainage hole
C2	Drainage hole of drain pan
D	Wires connection hole
E	Hanging bolt
F	Fresh air inlet
G	Fresh air outlet

MRV INDOOR UNIT DUCTED - FIXED FLOW

AD242MQERA AD282MQERA AD302MQERA

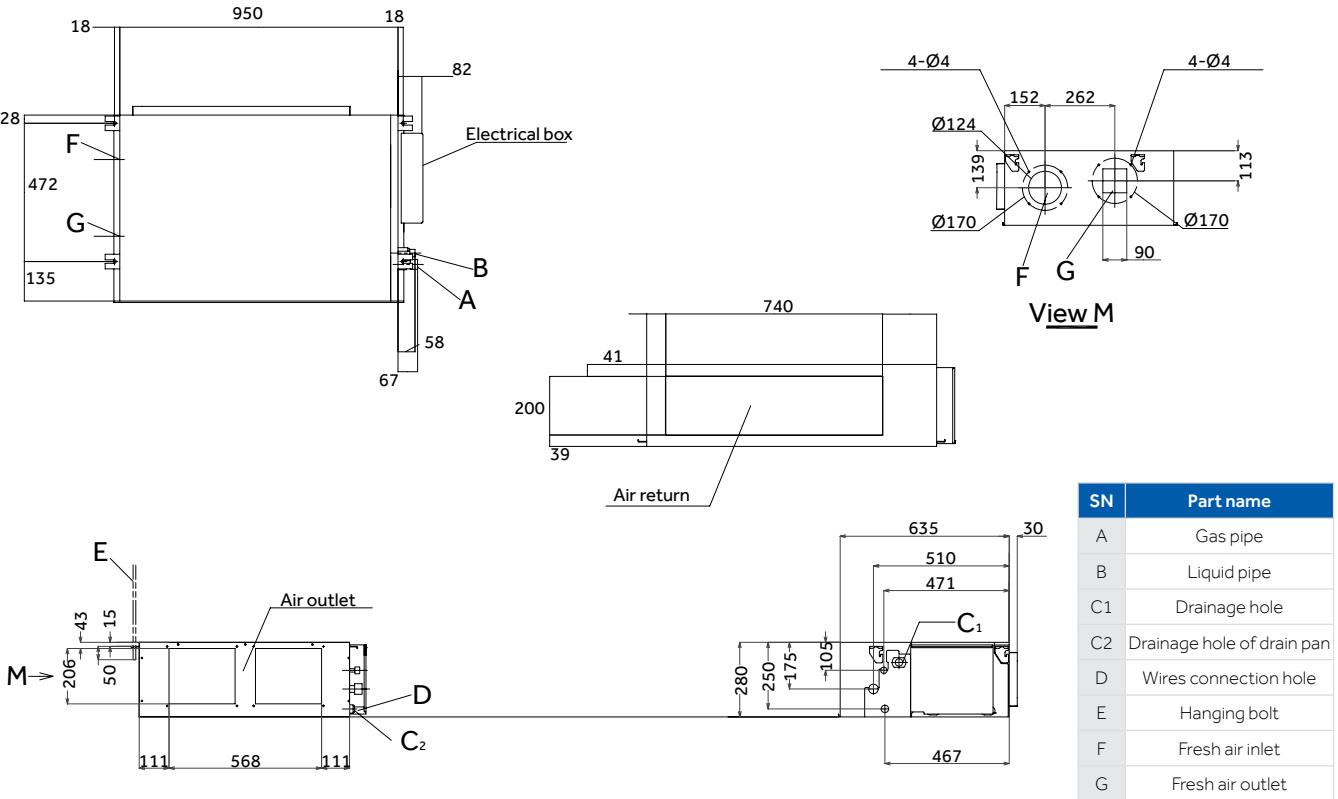

SN	Part name
A	Gas pipe
B	Liquid pipe
C1	Drainage hole
C2	Drainage hole of drain pan
D	Wires connection hole
E	Hanging bolt
F	Fresh air inlet
G	Fresh air outlet

The data in this catalogue is purely indicative as the data may vary. Please be advised to check the accuracy of the data with the supplier before purchasing products.

UNIT INTERNAL FLOOR CONSOLE, BUILT-IN

AE072MLERA AE092MLERA AE122MLERA AE162MLERA AE182MLERA AE242MLERA

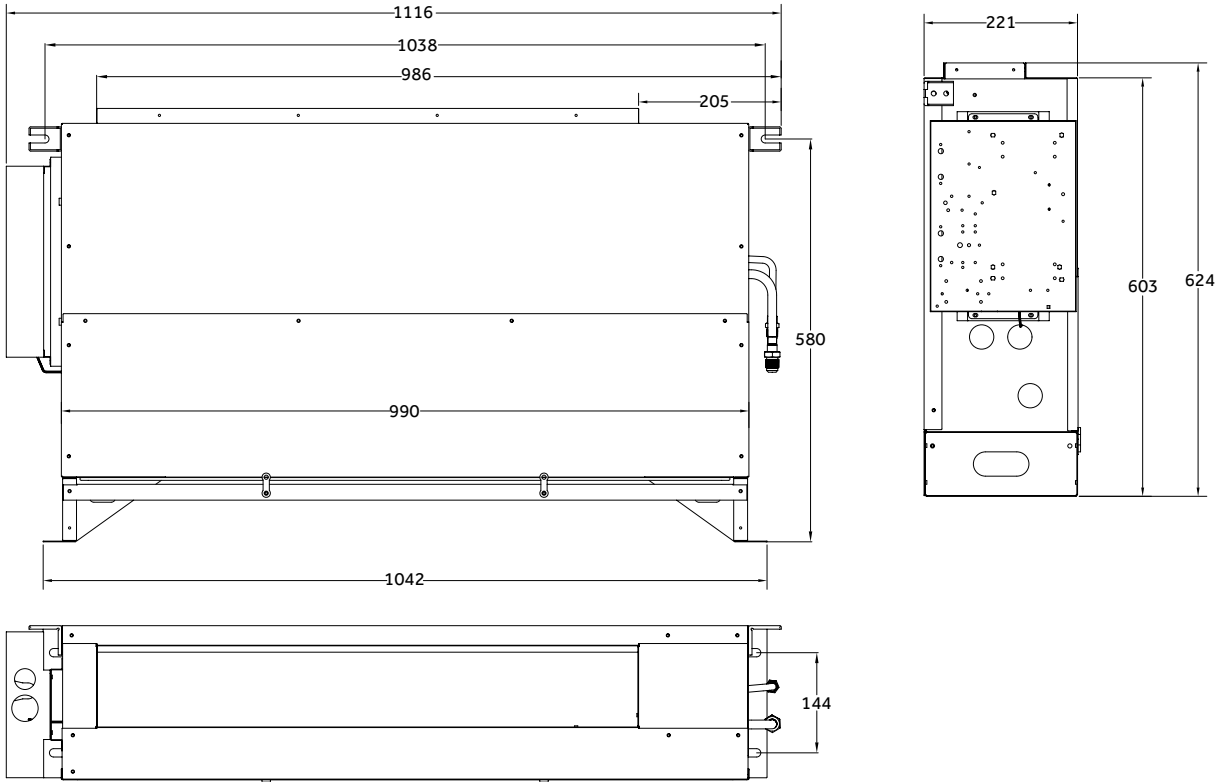

MRV INDOOR UNIT FLOOR CONSOLE, EXPOSED TYPE, DOUBLE FLOW

AF052MBERA AF072MBERA AF092MBERA AF122MBERA AF162MBERA AF182MBERA

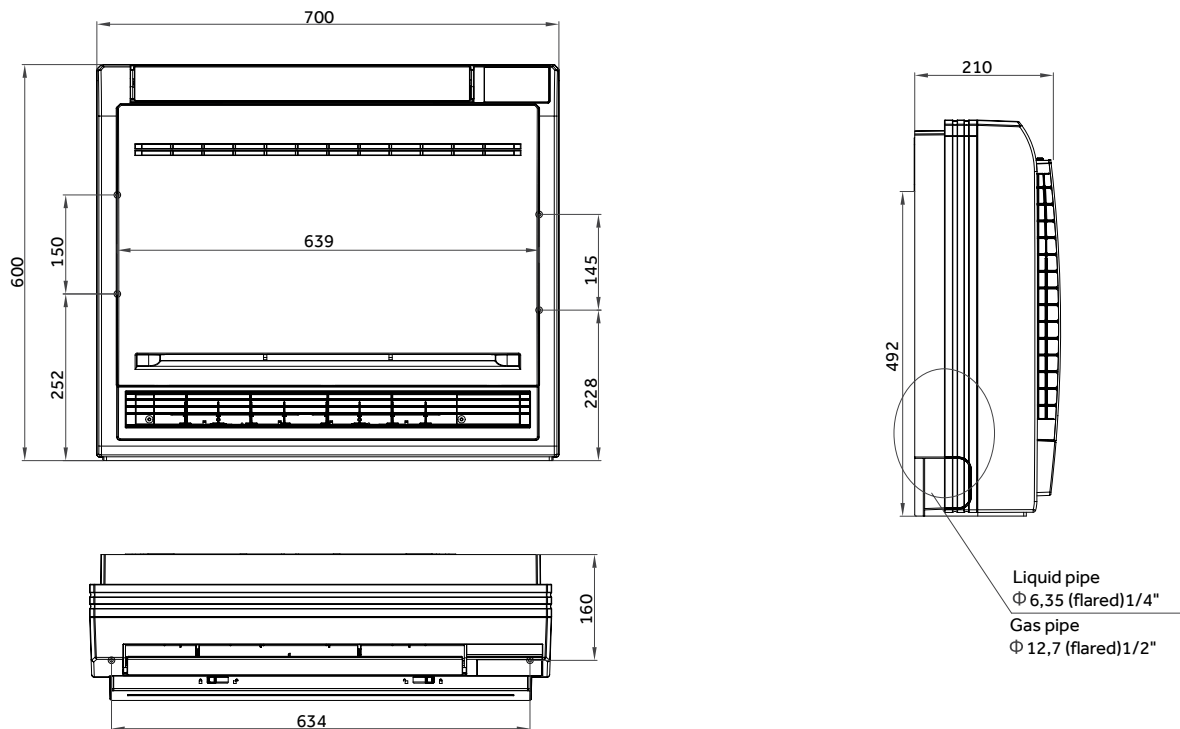

MRV INDOOR UNITS DUCTED FRESH AIR ALL OUTDOOR AIR

AD482MJERF AD722MJERF AD962MJERF

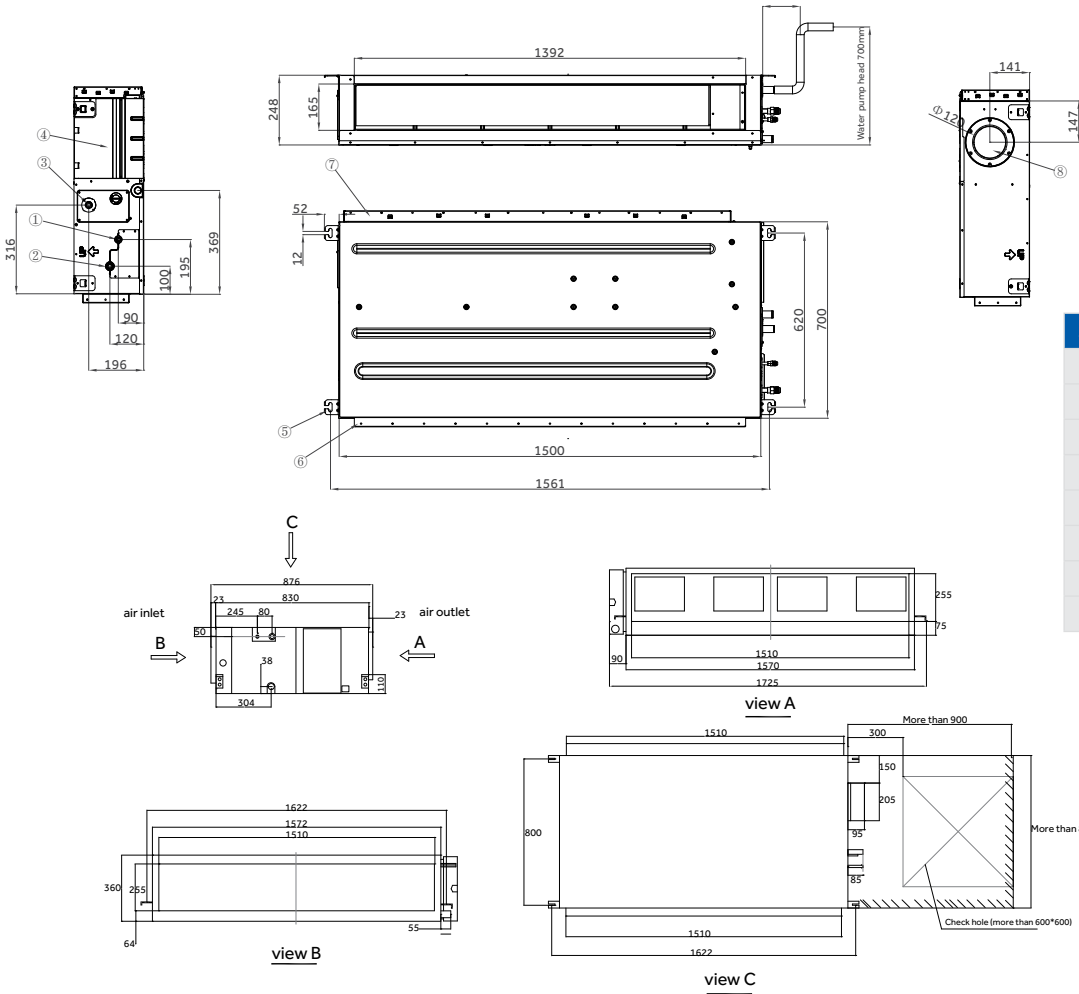



EASY MRV

Flexible,
high-efficiency
MRV systems

MS valves for
connecting residential
and commercial units

EASY MRV - FEATURES

EASY MRV SYSTEMS

Haier's "Easy MRV" system is the ideal solution for environments where an exceptionally low sound level is required by the indoor air conditioning unit.

Thanks to the external remote thermal expansion valves (MS valve box) it is possible to connect to our Supermatch indoor residential units. Which as standard are not equipped with a valve and ensure very low operating sound levels, to the MRV outdoor units (with some types of indoor units, you can reach 16 dBA). In addition, if you are looking for internal wall units with a modern and different design, with high class functionality and features, our FLEXIS and PEARL series connected to an "Easy MRV" system will meet your requirements.

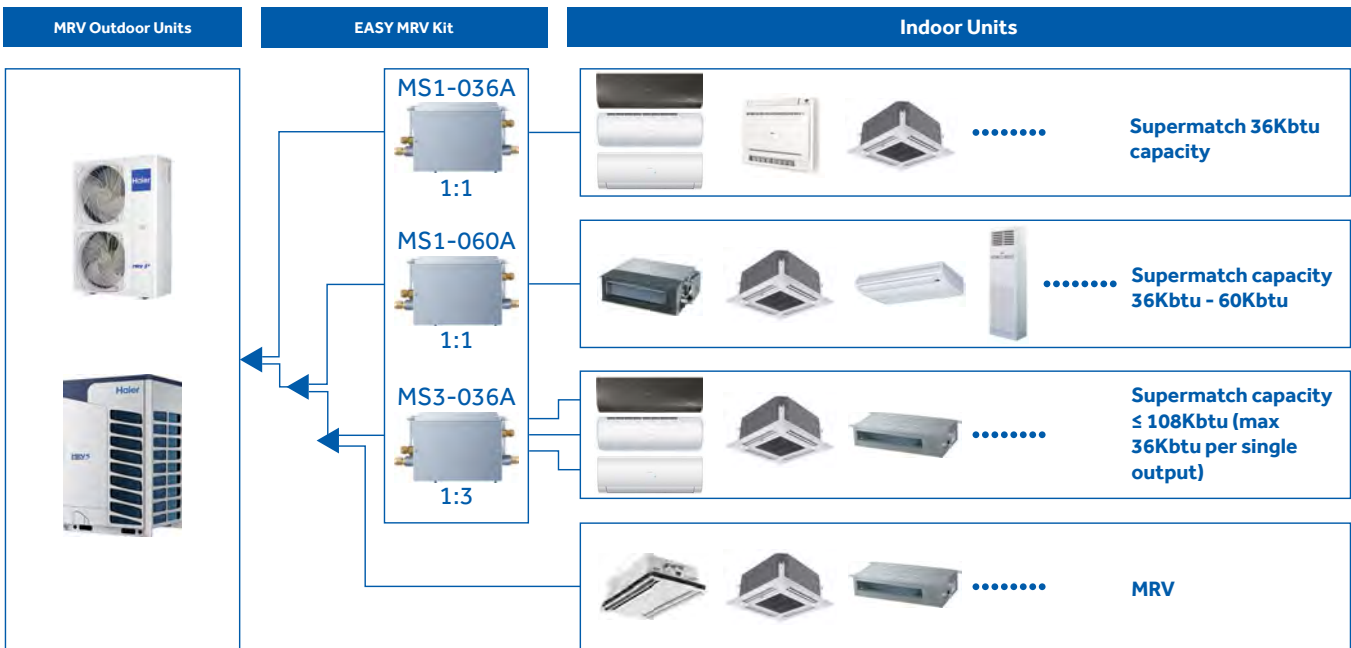

CONNECTIONS

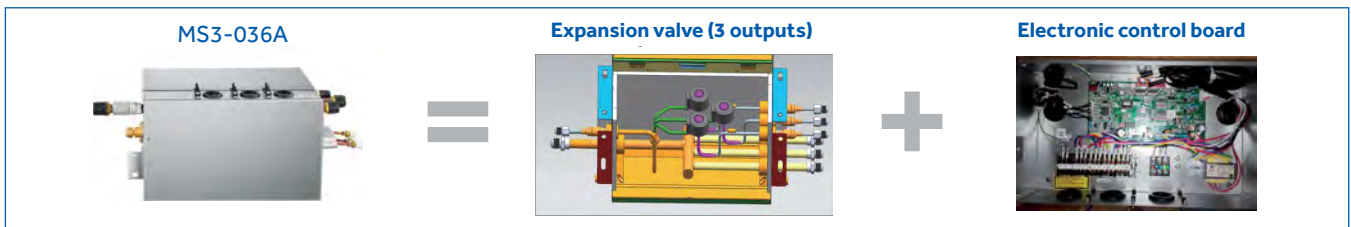
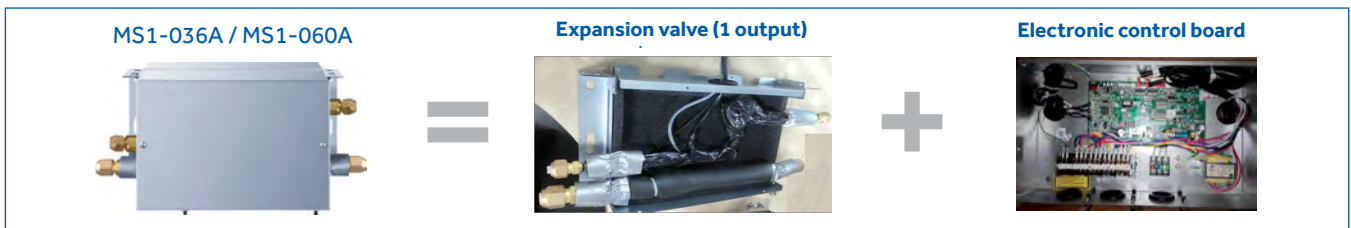

Haier's valve boxes have built-in gas pipes to facilitate installation without requiring welds due to utilising a flare connection.

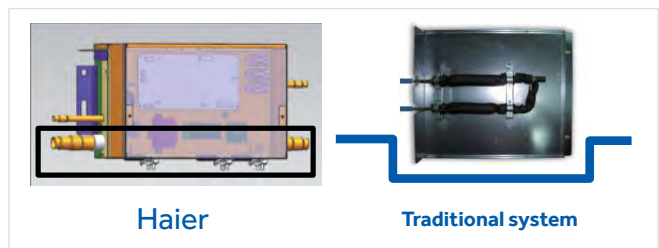

EASY MRV



MS1-036A
MS1-060A



MS3-036A

Model		MS1-036A	MS1-060A	MS3-036A
Max number of indoor units	No.	1	1	3
Maximum connectable indoor unit capacity	Btu/h	≤ 36Kbtu	36Kbtu - 60Kbtu	≤ 36Kbtu per single output (Tot. max 108Kbtu)
	kW	11,2	11,2 to 18,0 kW	Max 33,6 kW (max 11,2 kW per single output)
Power supply	V-Ph-Hz	220-230-1-50/60	220-230-1-50/60	220-230-1-50/60
Dimensions WxDxH	mm	310x217x155	310x217x155	394x227x253
Shipping Dimensions WxDxH	mm	509x285x209	509x285x209	687x295x303
Net weight	Kg	5	5	9
Material		Galvanised steel	Galvanised steel	Galvanised steel
Colour		Grey	Grey	Grey
Liquid pipe Ø	mm	9,52 (male) / 6,35	9,52 (male) / 12,7	6,35 (male) / 9,52 - 9,52 (male) / 12,7
Gas pipe Ø	mm	15,88 (male) / 12,7 / 9,52	19,05 (male) / 15,88	19,05 (male) / 15,88 - 15,88 (male) / 12,7 / 9,52
Connection type		Flare connection	Flare connection	Flare connection
Maximum piping length (BOX - IU)	m	15	15	15
Maximum height difference of pipes (BOX - IU)	m	15	15	15

AS25 - AS35 - AS42

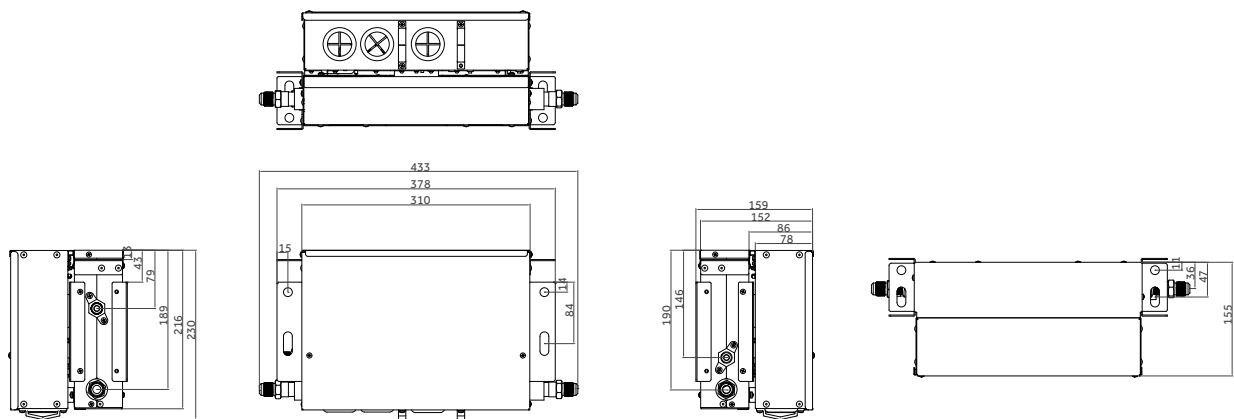

AS25 - AS35 - AS42

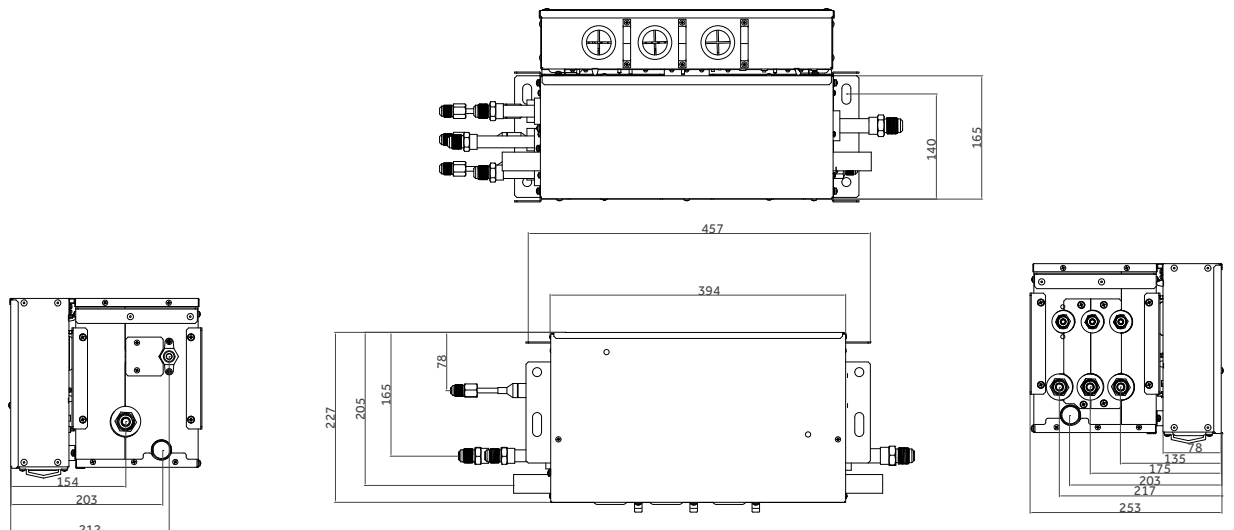

The data in this catalogue is purely indicative as the data may vary. Please be advised to check the accuracy of the data with the supplier before purchasing products.

COLLECTORS FOR 2-PIPE CIRCUIT ON THE SIDE OF INDOOR UNITS

Model	Pipes	Branch	Adapter, Included in the kit	Applicable power in kW (total sum of the nominal cooling powers of the indoor units connected to the collector)
FQG-H3704	Gas		2 PZ	up to 30 total (sum of all outputs) If you need to connect indoor units with power exceeding 5,6 kW, you must use model FQG-H3705 with more than 5 outputs for pipe diameter requirements
	Liquid			
FQG-H3705	Gas			up to 30 total (sum of all outputs)
	Liquid			
FQG-H3708_35kW	Gas			up to 35 total (sum of all outputs)
	Liquid			
FQG-H3708_70kW	Gas		1 PZ	up to 70 total (sum of all outputs)
	Liquid		1 PZ	

Diameters in inches (")											
1	6,35 mm	1/4"	5	19,05 mm	3/4"	9	31,75 mm	1"1/4	13	44,45 mm	1"3/4
2	9,52 mm	3/8"	6	22,40 mm	7/8"	10	34,92 mm	1"3/8	14	50,80 mm	2"
3	12,70 mm	1/2"	7	25,40 mm	1"	11	38,10 mm	1"1/2			
4	15,88 mm	5/8"	8	28,57 mm	1"1/8	12	41,28 mm	1"5/8			

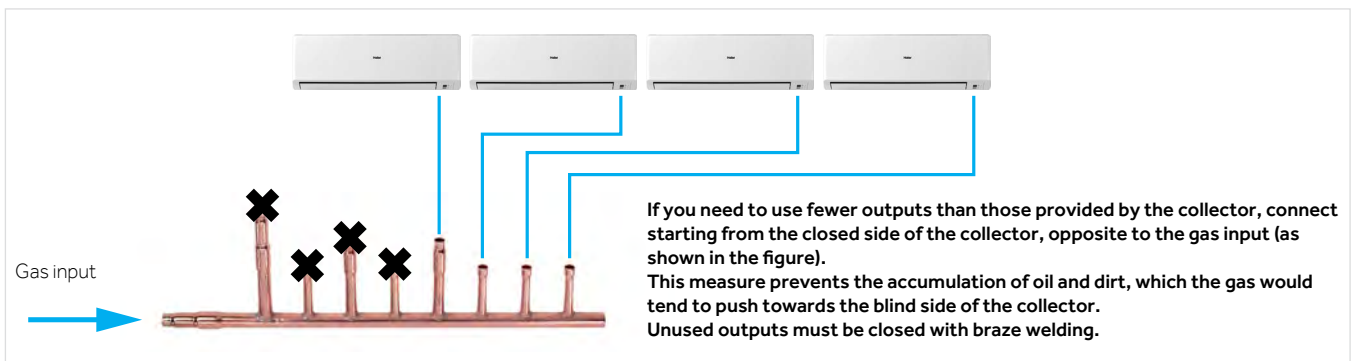

JOINTS TO COMBINE OUTDOOR UNITS WITH 3 HEAT RECOVERY TUBES

Measurements in millimetres ID - inner diameter / OD - outer diameter

HZG-R20B - kit to be provided to combine 2 modules			
Model	Pipes	ID	Branch
HZG-R20B	Gas Side Joint Recovery/ Return	A	
	Gas High Pressure Side Joint	B	
	Liquid Side Joint	C	

JOINTS TO COMBINE OUTDOOR UNITS WITH 3 HEAT RECOVERY TUBES

Measurements in millimetres ID - inner diameter / OD - outer diameter

HZG-R30B - kit to be provided to combine 3 modules			
Model	Pipes	ID	Branch
HZG-R30B	Gas Side Joint Recovery/ Return	D	
		E	
		F	
		G	
	Joint side Liquid	H	
		I	

The data in this catalogue is purely indicative as the data may vary. Please be advised to check the accuracy of the data with the supplier before purchasing products.

SOLDER JOINTS TO CREATE COOLING CIRCUITS

JOINTS TO COMBINE OUTDOOR UNITS WITH 3 HEAT RECOVERY TUBES

Measurements in millimetres ID - inner diameter / OD - outer diameter

HZG-R40B – kit to be provided to combine 4 modules				
Model	Pipes	ID	Branch	Gas Side Adapters Recovery/Return included in the kit
HZG-R40B	Joint side Liquid	P		
		Q		
		R		



MRV AHU

Applications

MRV AHU

INTRODUCTION & BENEFITS

APPLICATIONS

Regulations require adequate air renewal in the premises according to the activity carried out inside the building. Thanks to the interface kit between high efficiency MRV units and direct expansion air treatment units, Haier is able to meet the needs for air renewal and treatment.



GENERIC CONNECTION SCHEME

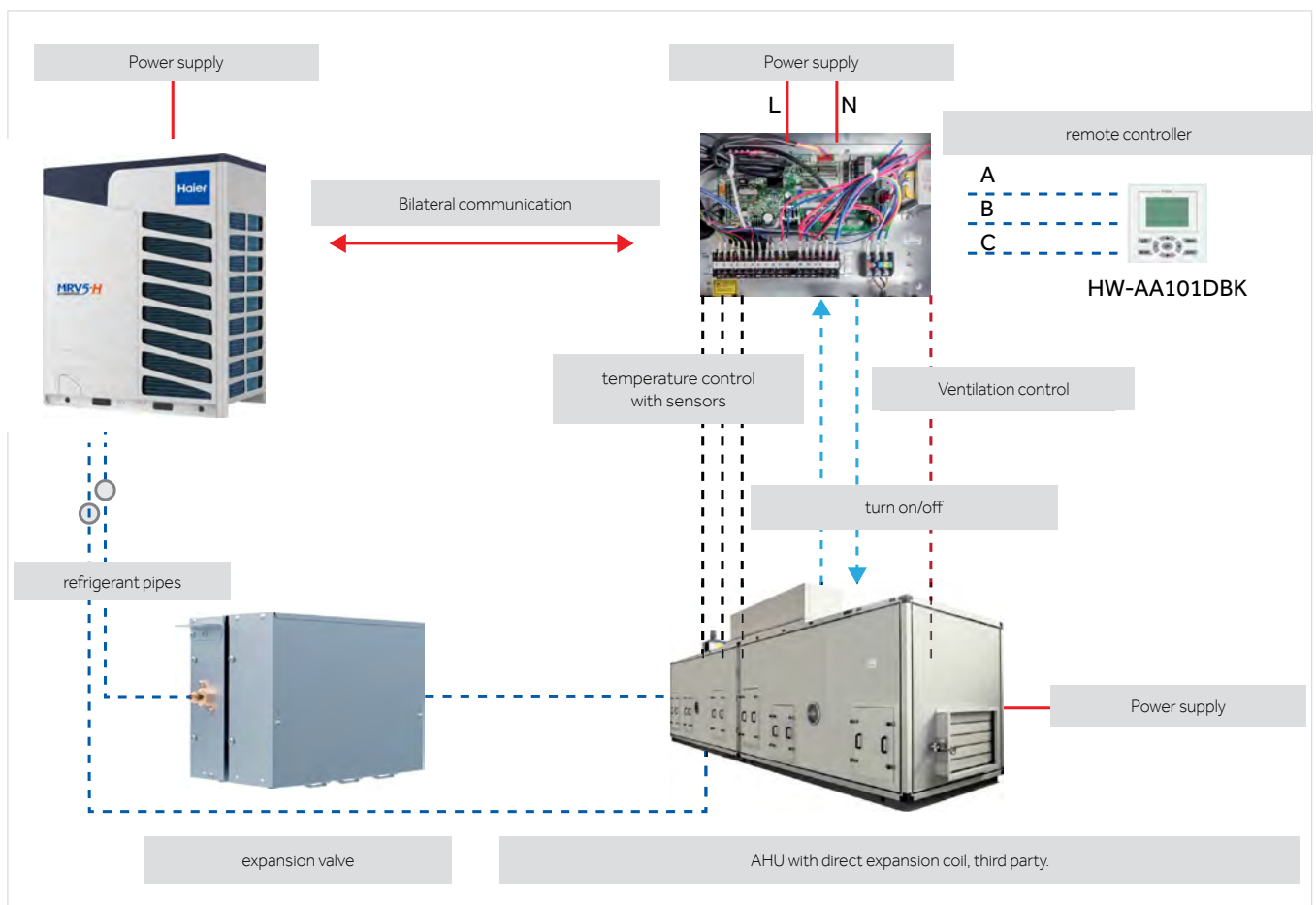

MRV AHU

CONNECTABLE OUTDOOR UNITS

Valve box	 <p>MRV-S</p>	 <p>MRV5-H</p>
Valve box	<p>AH1-070B - AH1-140B - AH1-280B</p>  <p>1HP (3,5kW) <AHU connection capacity ≤10HP (28,0kW)</p>	<p>AH1-280B - AH1-560B - AH1-730B</p>  <p>10HP (28,0kW) <AHU connection capacity ≤26HP (73,0kW)</p>
AHU	 <p>Third-party AHU</p>	

CONTENTS OF THE AHU KIT

<p>AH1-070B AH1-140B AH1-280B</p> 	<p>=</p> <p>Refrigerant expansion valve included</p> 	<p>+</p> <p>Control electronics included</p> 	<p>+</p> <p>Temperature sensors and wiring included</p> 	<p>+</p> <p>HW-AA101DBK wired touch screen remote control included</p> 
---	--	--	--	--

<p>AH1-560B AH1-730B</p> 	<p>=</p> <p>Refrigerant expansion valve included</p> 	<p>+</p> <p>Control electronics included</p> 	<p>+</p> <p>Temperature sensors and wiring included</p> 	<p>+</p> <p>HW-AA101DBK wired touch screen remote control included</p> 
--	--	--	--	--

MRV AHU

CONTROL AND MANAGEMENT SYSTEMS

A Haier MRV-AHU system is comparable to a classic VRF system, therefore it can be inserted in a group control context.

Example

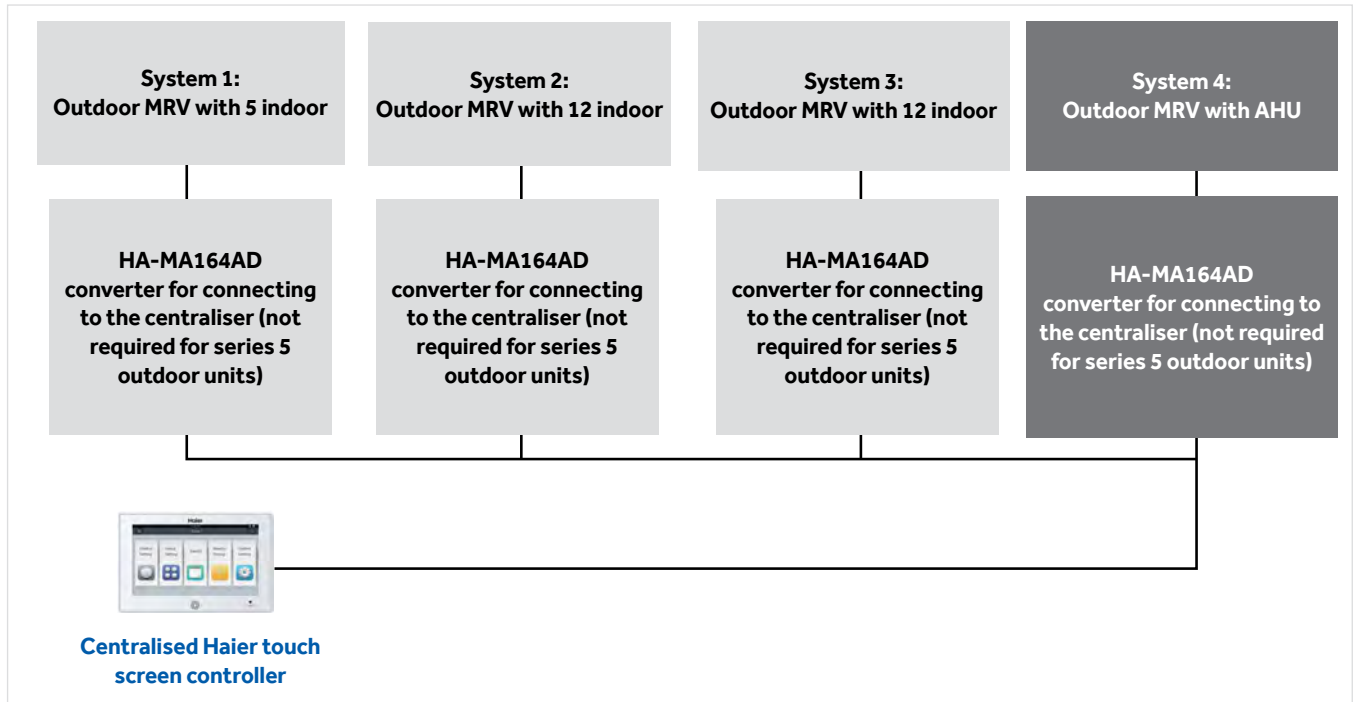

SIMPLE INSTALLATION

Compared to a traditional water system, Haier's AHU-MRV direct-expansion technology minimises plant components. No cooling towers, large water pipes or pumps are needed. In addition, the efficiency of MRV/VRF/VRV systems is notoriously higher than traditional air/water systems. Haier AHU-MRV systems can be independently or centrally controlled thanks to Haier's multiple solutions for product control and management. It is also possible to power MRV and AHU indoor units within the same plant.

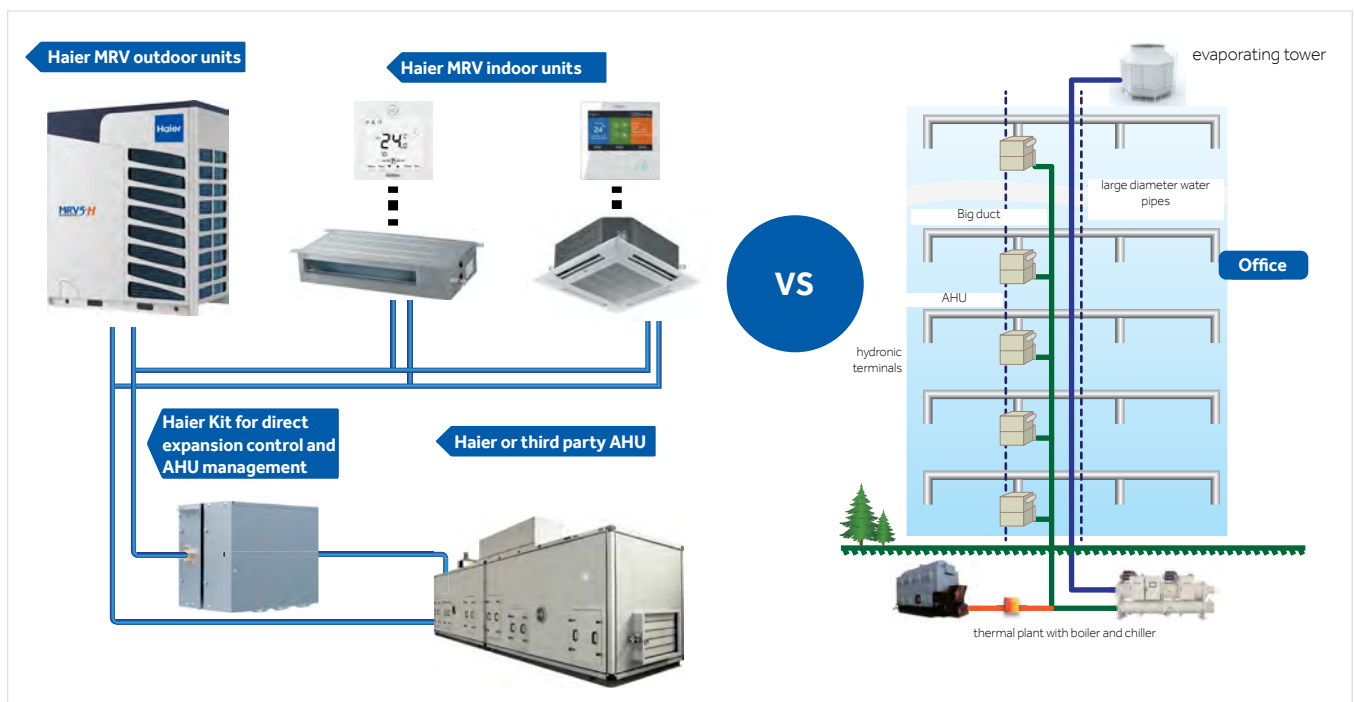

MRV AHU

CHARACTERISTICS AND FUNCTIONS

- Ability to control third-party AHU
- Compatible with MRV 5-series outdoor units and MRV SII series" (4-12 HP)
- A single box covers a power range of 3,5 to 73,0 kW. Can to connect up to 3 boxes in parallel for large capacity.
- Expansion valve and paired electronic boards, with separation possibilities for greater flexibility during installation.
- Managing 0-10 V DDC inbound signal from third-party controller
- Temperature signal control provided by a DDC control or return from the Haier sensor
- Remote contact input to select Hot/Cold mode
- Clean contact input for managing 3 ventilation speeds
- Status signal output "Defrost / Defrost"

TECHNICAL SPECIFICATIONS





AH1-070B
AH1-140B
AH1-280B



AH1-560B
AH1-730B

Model		AH1-070B	AH1-140B	AH1-280B	AH1-560B	AH1-730B
Connectable capacity (kW AHU intertial exchanger)	kW	3,5≤X≤7,0kW (1-3HP)	7,0≤X≤14,0kW (3-5HP)	14,0≤X≤28,0kW (5-10HP)	28,0≤X≤56,0kW (10-20HP)	56,0≤X≤73,0kW (20-26HP)
Power supply	V-Ph-Hz	220-230-1-50/60	220-230-1-50/60	220-230-1-50/60	220-230-1-50/60	220-230-1-50/60
Unit Dimensions WxDxH	mm	420x260x165	420x260x165	420x260x165	420x260x215	420x260x215
Packaged unit dimensions WxDxH	mm	520x340x225	520x340x225	520x340x225	520x340x275	520x340x275
Net weight / Gross weight	Kg	5,5 / 8,5	5,5 / 8,5	5,5 / 8,5	6,5 / 10,0	6,5 / 10,0
Material		Galvanised sheet				
Colour		Grey	Grey	Grey	Grey	Grey
Liquid pipe diameter (input/output to AHU)	mm (inch)	9,52 (3/8) / 6,35 (1/4)	9,52 (3/8) / 6,35 (1/4)	9,52 (3/8) / 6,35 (1/4)	12,70 (1/2) / 15,88 (5/8)	12,70 (1/2) / 15,88 (5/8)
Connection method		Flare	Flare	Flare	Flare	Flare
Maximum distance between BOX and AHU	m	5	5	5	5	5
Maximum height difference between BOX and AHU	m	5	5	5	5	5

ADVANTAGES

Valve capacity	Possibility to control AHU with power values from 3 to 73 kW with a single valve
High compatibility	The same electronic boards as the MRV indoor units for simple management and maintenance
Reliability	<p style="text-align: center;">The expansion valve is produced by FUJIKOKI, the Japanese leader in this sector.</p> <div style="display: flex; justify-content: space-around; align-items: center;">   </div>

Control method "A"

The third-party control system generates a signal ranging from 0-10 V to represent the required power demand. Haier's AHU Kit uses this input signal to adjust the power delivered by the MRV unit to meet the real need for thermal air treatment.

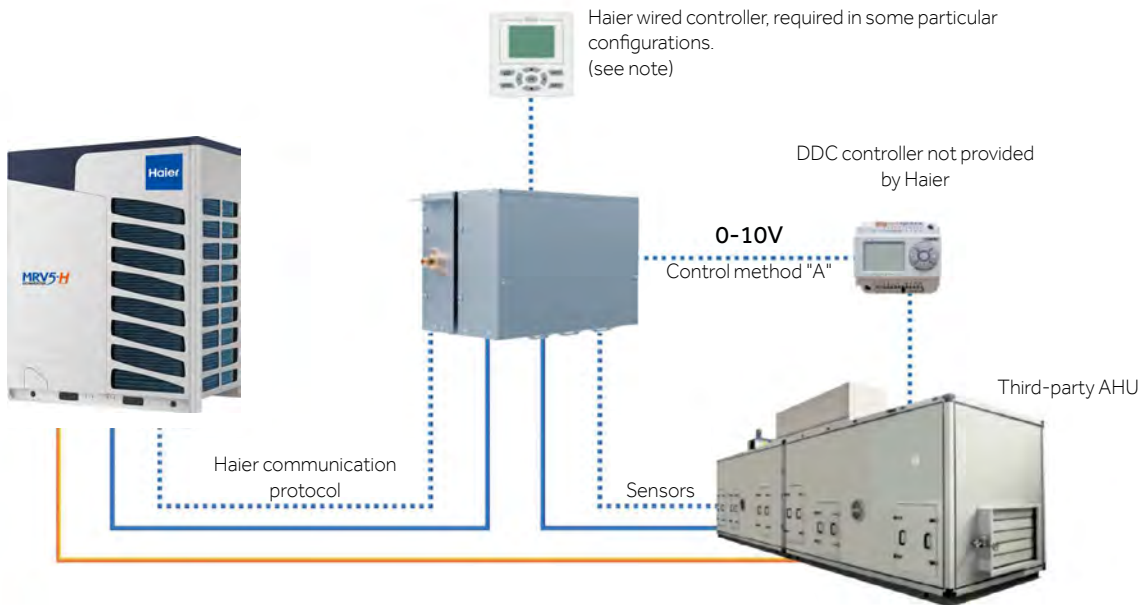

Liquid/Gas refrigerant pipes, only the liquid pipe enters the valve box and then continues to the direct expansion coil. The Gas pipe goes directly from the outdoor unit to the coil inside the AHU.

Note:

If the third-party DDC controller generates only the 0-10 V demand indicator signal, the Haier wired controller is necessary to handle the following signals: Hot/cold operating mode, switching AHU on/off, alarms.
If the DDC controller generates all the necessary signals, the Haier controller is not required.

Control method "B"

The temperature is controlled by the third-party DDC, which sends the 0-10 V modulating signal to the Haier kit that will control the temperature set point.

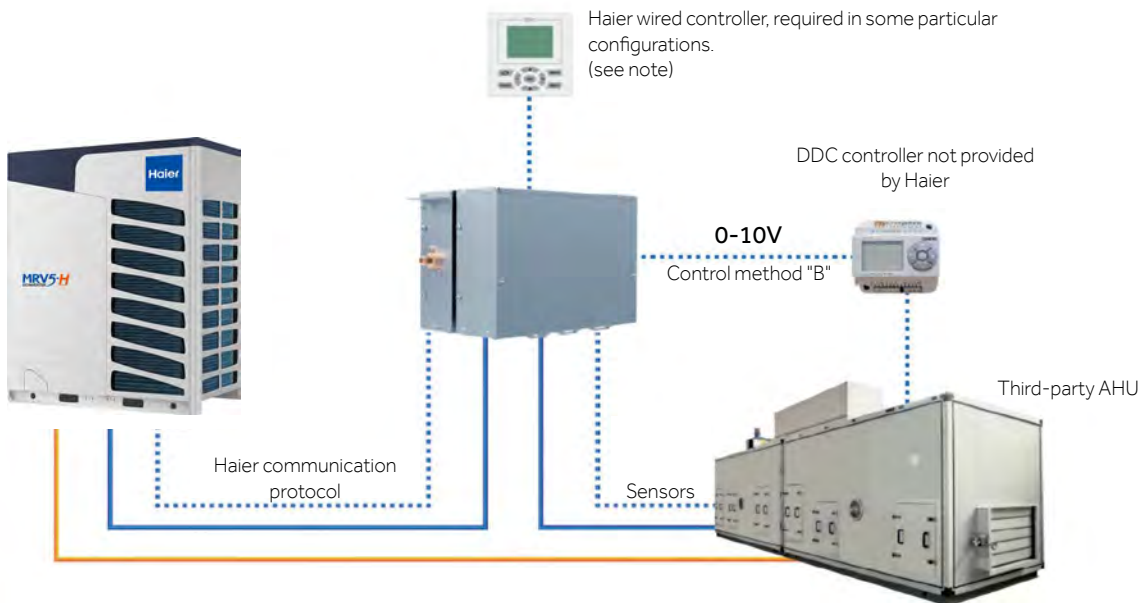

Liquid/Gas refrigerant pipes, only the liquid pipe enters the valve box and then continues to the direct expansion coil. The Gas pipe goes directly from the outdoor unit to the coil inside the AHU.

Note:

If the third-party DDC controller only generates the 0-10 V signal corresponding to the required temperature set point, the Haier wired controller is necessary to handle the following signals: Hot/cold operating mode, switching AHU on/off, alarms. If the DDC controller generates all the necessary signals, the Haier controller is not required.

Control method "C", special applications

Configuring the system WITHOUT a third-party DDC. In this case, the Haier controller is necessary to make all the settings. This system requires the installation of an on/off thermostat that switches on or off the AHU when the temperature set point is reached. This "C" method is used to continuously heat or cool in an on/off manner, without modulation and therefore with less comfort in the environments.

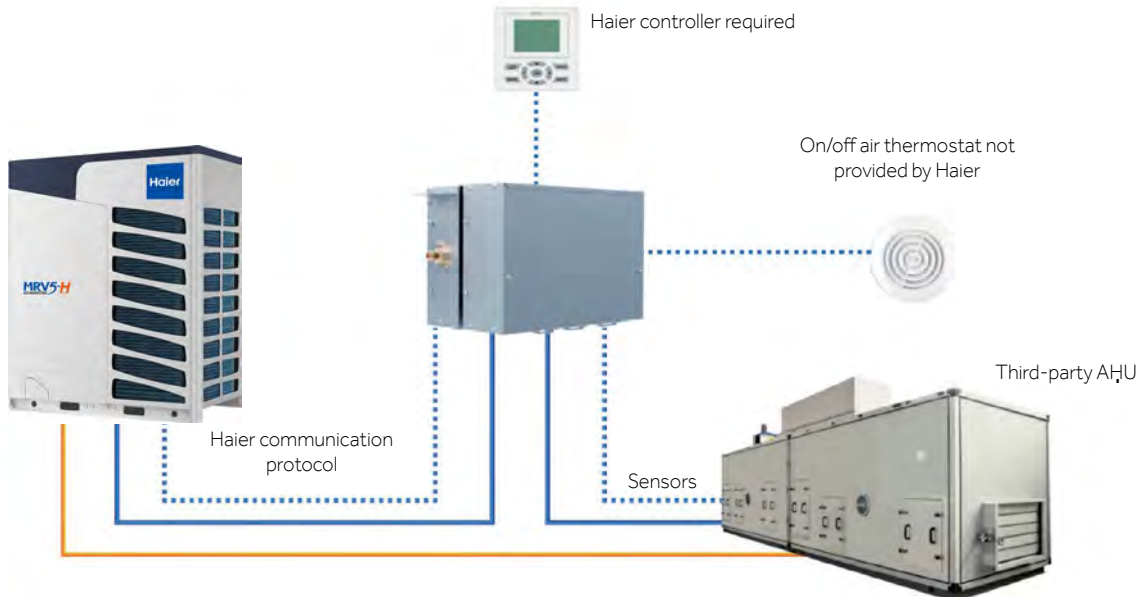

Liquid/Gas refrigerant pipes, only the liquid pipe enters the valve box and then continues to the direct expansion coil. The Gas pipe goes directly from the outdoor unit to the coil inside the AHU.

Control method "D"

MRV and AHU mixed air conditioning system work in the same cooling circuit with MRV Haier and third-party AHU indoor unit. In this case Haier controller is required.

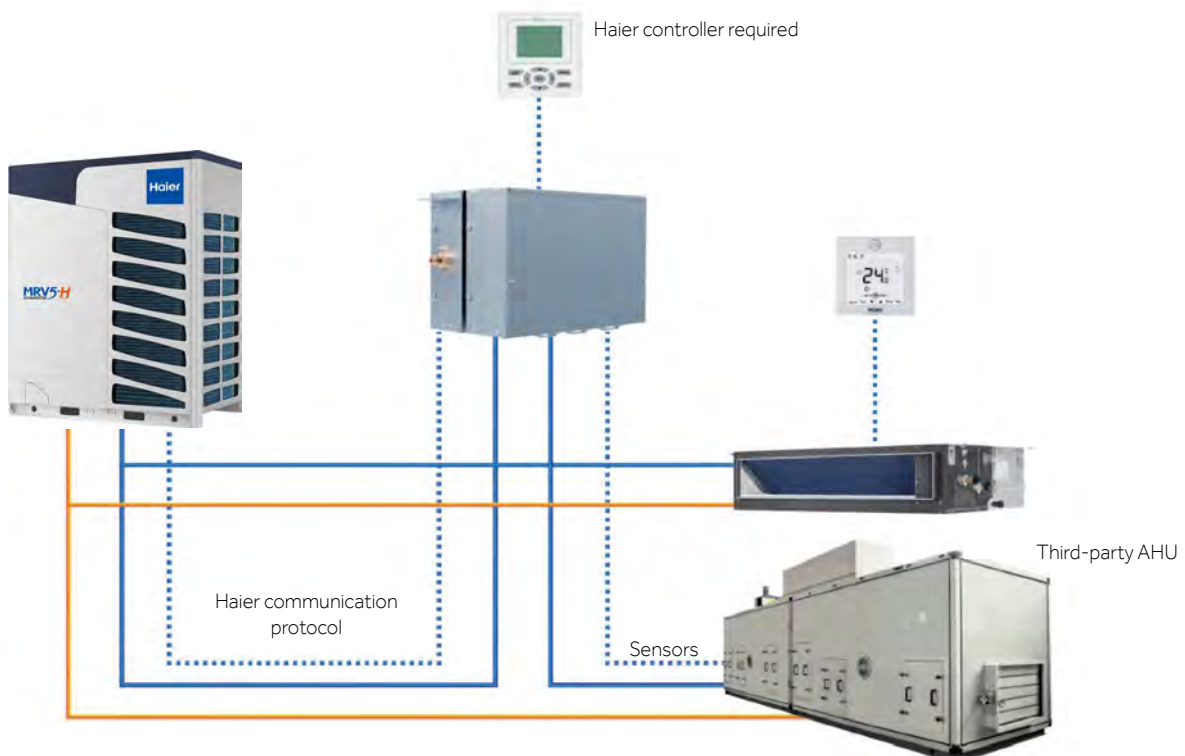

Liquid/Gas refrigerant pipes, only the liquid pipe enters the valve box and then continues to the direct expansion coil. The Gas pipe goes directly from the outdoor unit to the coil inside the AHU.



Control & Management Systems

SIMPLE AND INTUITIVE SOLUTIONS TO MANAGE PLANTS

A SINGLE INTEGRATED SYSTEM

Haier's communication protocol is unique to MRV systems and the residential and commercial products of the Supermatch line. This allows the same controls to be used for both small and large MRV plants.

MANAGEMENT AND SUPERVISION

Haier provides reliable and professional supervision systems for better management of preventive maintenance as well.

"SMART" CONTROLS

Systems that can be customised to meet your needs.



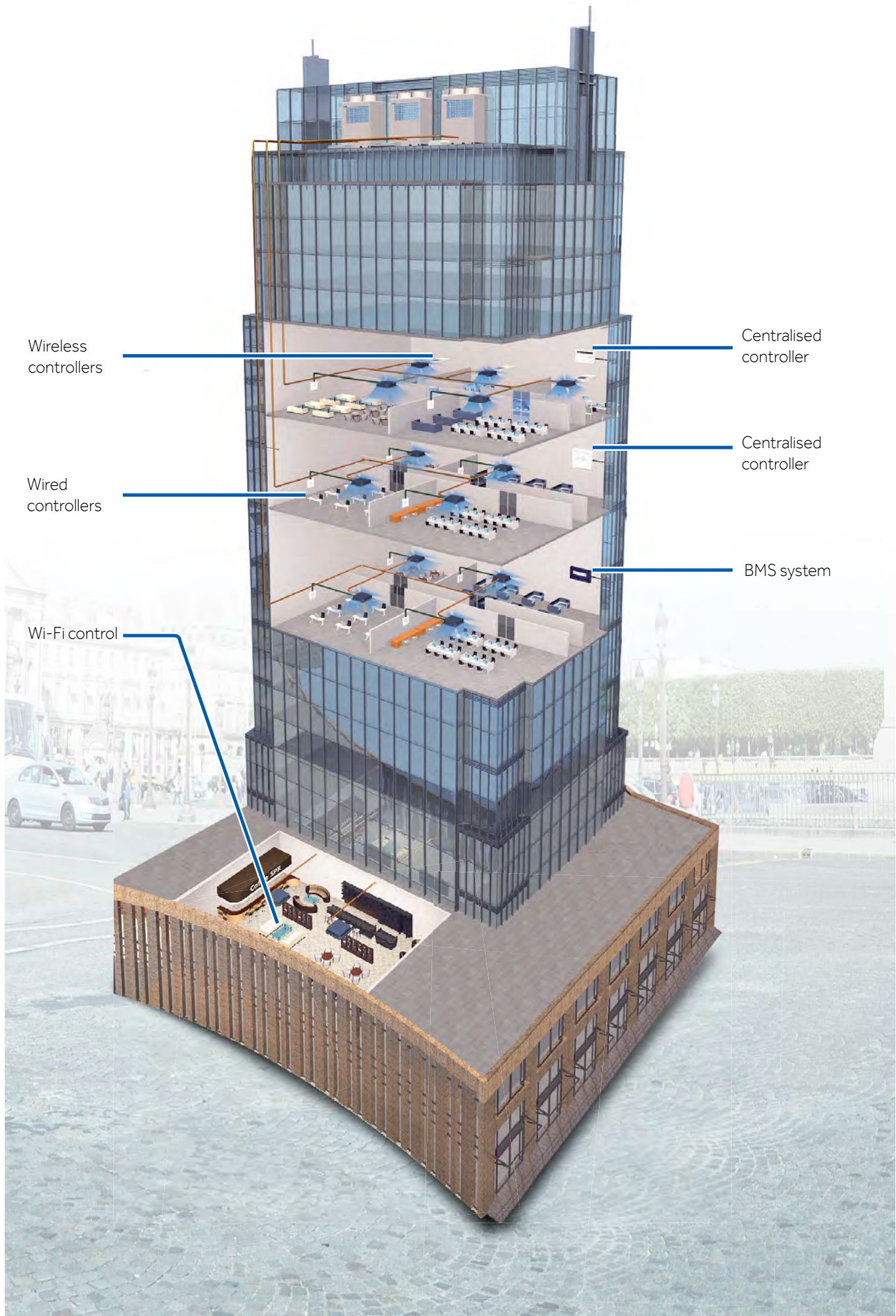

CENTRALISED CONTROL

The centralised controls provide a customised control of the entire system from a single point. Manage individual units, groups, or zones and define different settings for each of them.

5" HC-SA164DBT
UP TO 64 INDOOR UNITS



7" YCZ-A004
UP TO 256 INDOOR UNITS



12,5" HC-LA1CDBT
UP TO 800 INDOOR UNITS

MULTI-LANGUAGE



HC-SA164DBT

- Possibility to control via WEB/Internet by means of optional Wi-Fi module HI-WA164DBI
- Intelligent system for plants up to 64 indoor units
- 5" LCD TFT full touchscreen display backlit
- Built-in weekly timer
- Possibility of naming units and groups
- Displaying alarms
- Requires HA-MA164AD except when connected directly to MRV5 versions or MRV S II (AU**NFKERA) – for details see following pages
- 32 independent cooling circuits, each with their own HA-MA164AD converter
- Ability to simultaneously control MRV units and Split units Supermatch / Residential.
- MODBUS output as standard

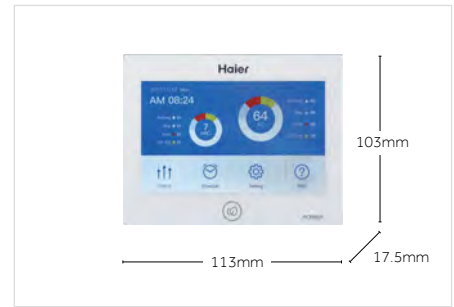

YCZ-A004

- Smart system for medium size plants up to 256 indoor units
- Large 7" LCD TFT full touchscreen display
- Built-in weekly timer
- Possibility of naming units and groups
- Displaying alarms
- Requires HA-MA164AD except when connected directly to MRV5 versions or MRV S II (AU**NFKERA) – for details see following pages
- 32 independent cooling circuits, each with their own HA-MA164AD converter
- **You cannot control MRV units and Supermatch/Residential with the same controller**
- MODBUS output as standard



HC-LA1CDBT

- 12,5-inch TFT LCD touch screen
- Max. 800 MRV indoor units and Max. 128 LCAC IDUs connectable for one controller (totally 928) IDUS connectable
- Floor plan layout view
- Web Access and Email Alarm
- Weekly Schedule and Special day setting
- Integrate 3rd party devices like fire alarm, lighting with Haier indoor units
- All MRV system requires the gateway HA-MA1ADB (one system requires one gateway)
- LCAC products requires PCB adapter YCJ-A002 (One IDU requires one YCJ-A002)
- Total electricity consumption display and consumption distribution for tenant billing (the amp meter would need to be connected to HA-MA1ADB)
- Data curve

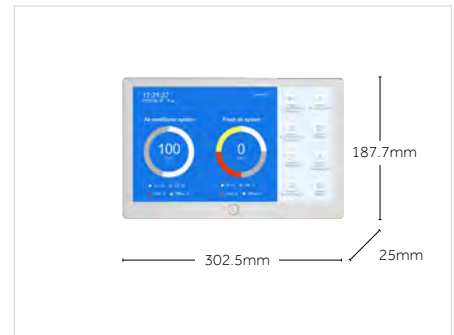

HA-MA164AD

- Haier protocol converter to RS-485
- To be connected to centralised systems (not required for series 5 outdoor units)
- Each cooling circuit needs 1 converter
- 1 converter can handle max 64 internal units on single cooling circuit
- This accessory, if NOT connected to a centralised controller as a dedicated converter, can be used individually to transform the communication protocol "Homebus Haier" into "MODBUS". (For this feature, configure the selectors in the desired mode)

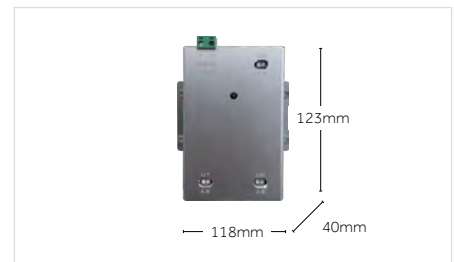

HA-MA1ADB

- Interface: Modbus
- Match with 12,5-inch webserver central controller HC-LA1CDBT
- Max. 128 indoor units connectable
- Digital tube display Indoor quantity, gateway address, time and date
- Electricity data collection, calculation, distribution and storage

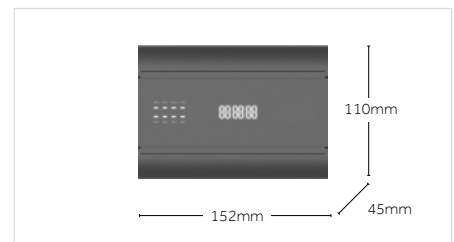

HI-WA164DBI (WI-FI MODULE)

Features:

This module, connected to an Internet access with Wi-Fi, allows remote control via dedicated APP on tablets and smartphones (no PC).

Each Wi-Fi module can control up to 64 indoor units.

Through the APP, the same functionality as the centraliser, connected to the MRV system, is replicated and managed.

Specifications:

- Control functions, on/off, temperature setting, timer settings, weekly, fan speed.
- Alarm monitoring function, errors, error history.
- User account management, including account registration, password change and account information modification via APP.
- Convenient sharing of the management authority. The primary account can share the management of the primary account with the secondary accounts, without re-registering the units.
- Each individual APP can handle up to 256 indoor units.
Example: 4 Wi-Fi modules with 64 Interior each, or 7 Wi-Fi modules with 36 interiors each
- If a HC-SA164DBT centralised controller is used directly, the Wi-Fi module can be connected directly to the centraliser on a dedicated terminal.
- The Wi-Fi module can be connected directly to the MRV series 5 outdoor units, or to the HA-MA164AD converter if the outdoor units are NOT series 5.

With this configuration it is possible to control the MRV system even without local centralised controllers, using only the APP installed on tablet or smartphone, by ensuring stable and fast Wi-Fi coverage to the module.

If used independently (not connected to a centralized controller) it is necessary to provide 12 DC electric supply (not provided by Haier)

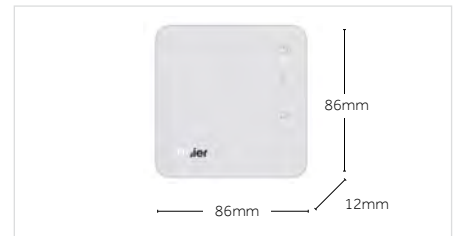

HC-SA164DBT

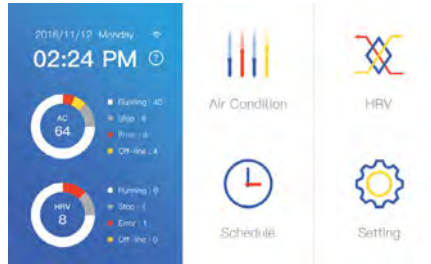

- Control of up to 64 indoor units
- Control of the operating mode, temperature, ventilation, deflectors
- Error control and alarm memory



- Daily and weekly programming for single unit
- Free and independent programming

HC-LA1CDBT

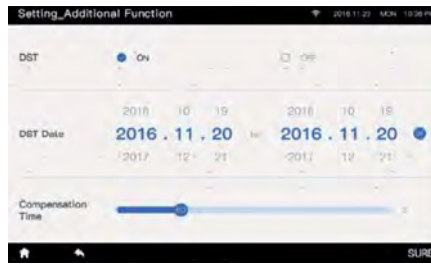

- Monitoring the status of each individual unit

HA-MA1ADB

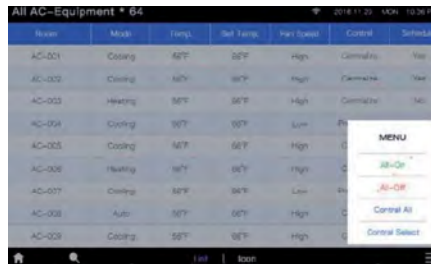

- Individual - group - total visualisation

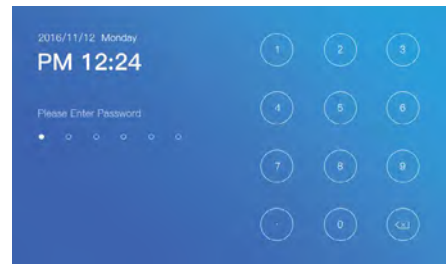

- Password setting at different levels of operation

YCZ-A004



Monitoring and control

- Control of up to 256 indoor units
- Control of the operating mode, temperature, ventilation, deflectors
- Icons displayed similar to those on remote commands



Power-saving function

- User function locking mode
- Defining lower and upper limits for desired temperature selection



Zone management

- Defining zones as per user requests



Timer programmer

- Daily and weekly programming for single unit
- Free and independent programming

WI-FI FEATURES

This module, connected to an Internet access with Wi-Fi, allows remote control via dedicated APP on tablets and smartphones (no PC). Each Wi-Fi module can control up to a maximum of 64 indoor units, which is the limit of the centraliser. Through the APP, the same functionality as the centraliser, connected to the MRV system, is replicated and managed.

SPECIFICATIONS

- It is connected to the centraliser through the cable supplied, from which it is powered.
- It can be connected up to 100 meters from the centraliser, so as to reach an area covered by Wi-Fi
- Control functions, on/off, temperature setting, timer settings, weekly, fan speed.
- Alarm monitoring function, errors, error history.
- User account management, including account registration, password change and account information modification via APP.
- Convenient sharing of the management authority. The primary account can share the management of the primary account with the secondary accounts, without re-registering the units.
- Each individual APP can handle up to 256 indoor units.
Example: 4 Wi-Fi modules with 64 Interior each, or 7 Wi-Fi modules with 36 interiors each
- The Wi-Fi module can be connected directly to the MRV series 5 outdoor units, or to the HA-MA164AD converter if the outdoor units are NOT series 5. With this system you can control the MRV system even without a centraliser installed, but through the APP alone by ensuring adequate Wi-Fi coverage to the module.
- The APP is available for Android and iOS.



**WI-FI MODULE
HI-WA164DBI**

HAIER SMART AIR 2

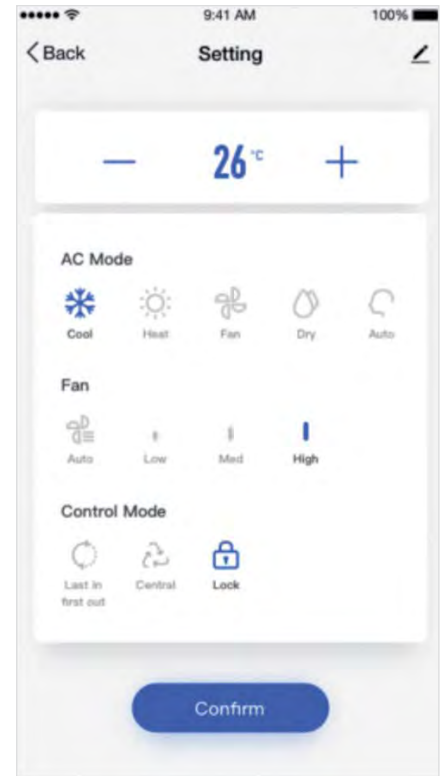
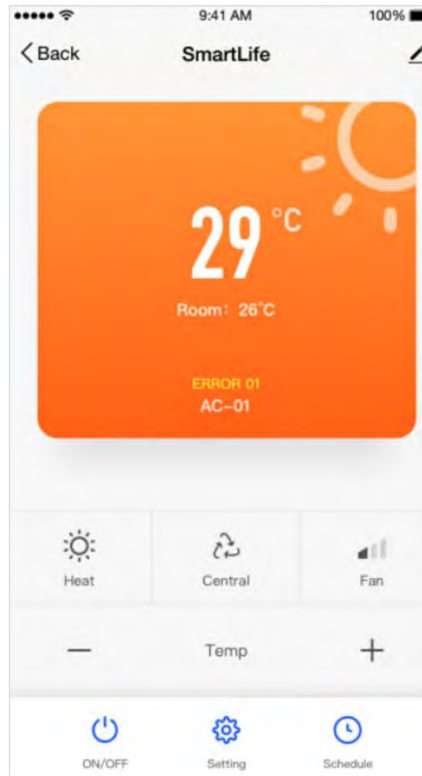

HI-WA164DBI WI-FI MODULE FOR CENTRALISED CONTROLLER HC-SA164DBT



CONFIGURATION WITH CENTRALISER

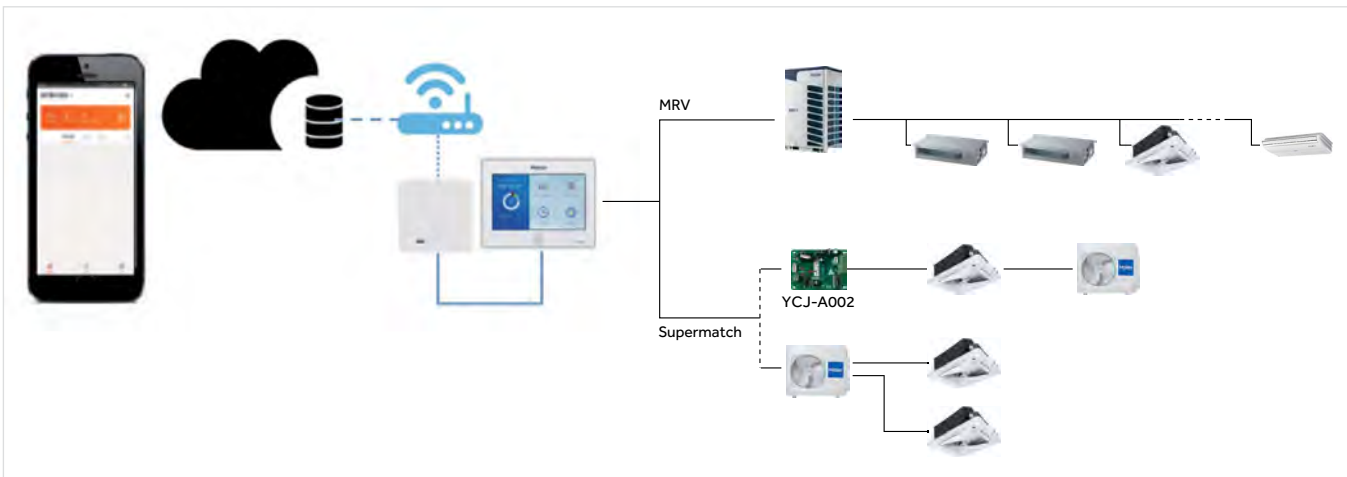

CONFIGURATION WITHOUT CENTRALISER

The Wi-Fi module can be connected directly to the MRV series 5 outdoor units, or to the HA-MA164AD converter connected to other non-series 5 MRV outdoor units.

With this system you can control the MRV system even without a centraliser installed, but through the APP alone by ensuring adequate Wi-Fi coverage to the module.

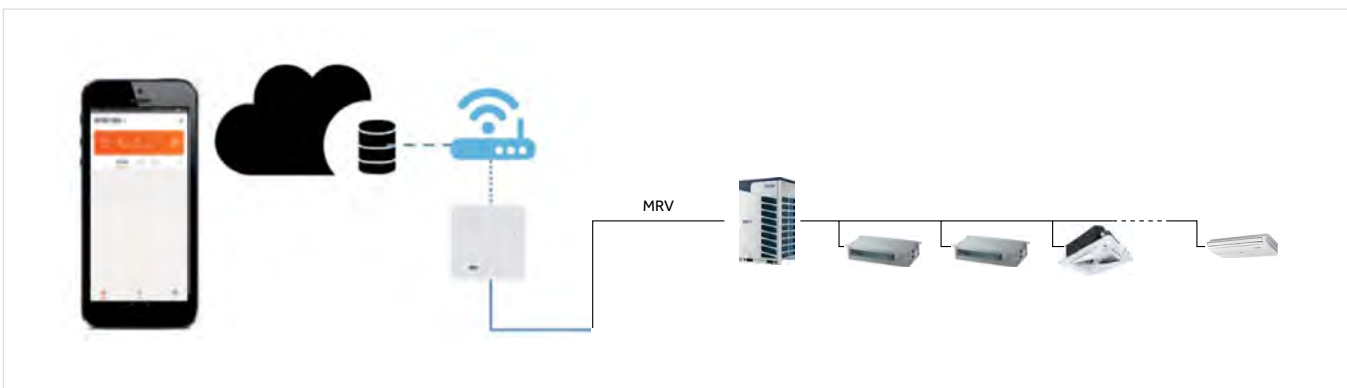

If used independently (not connected to a centralized controller) it is necessary to provide 12 DC electric supply (not provided by Haier)

EXAMPLES OF CONNECTION FOR THE "HI-WA164DBI" WI-FI MODULE ACCORDING TO THE TYPE OF SYSTEM AND THE EXPECTED PRODUCTS

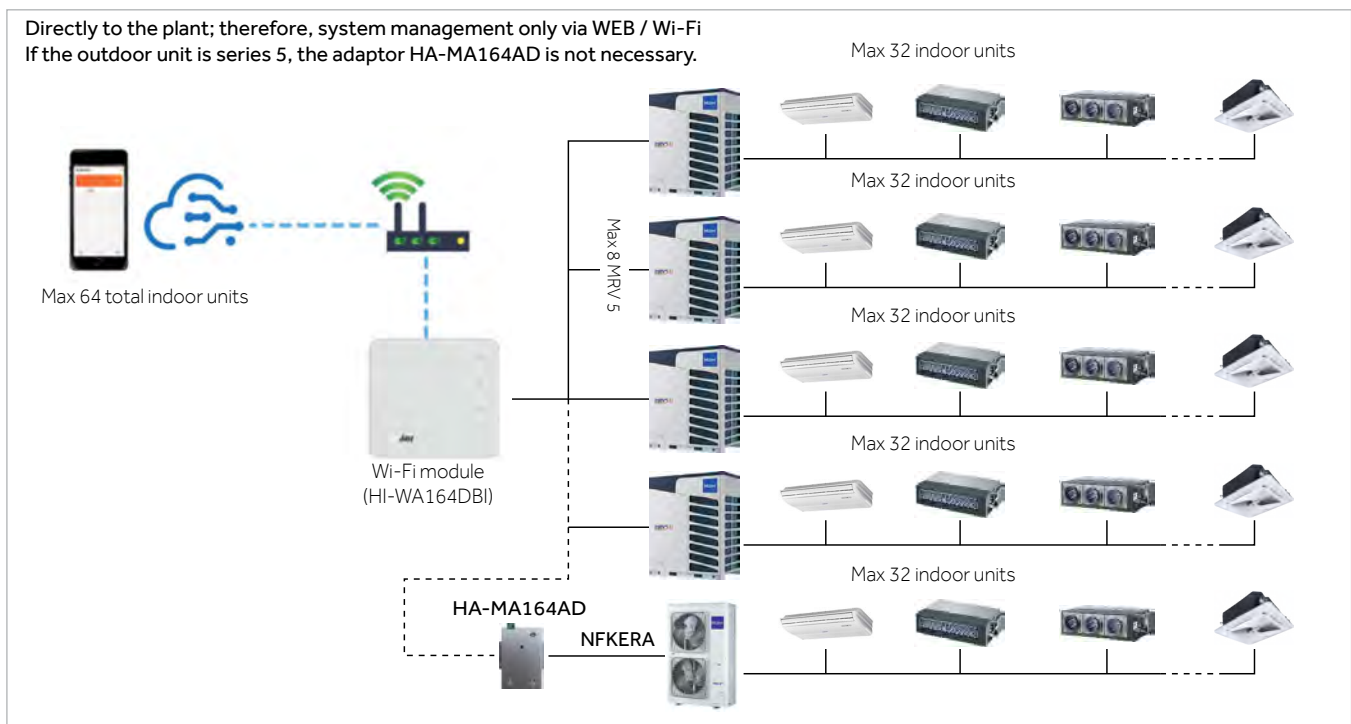
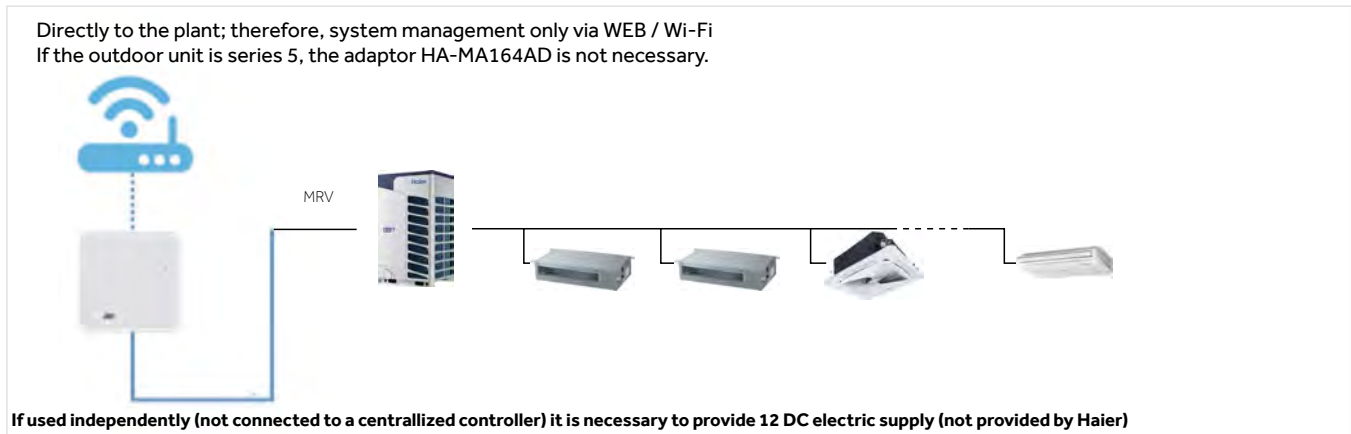
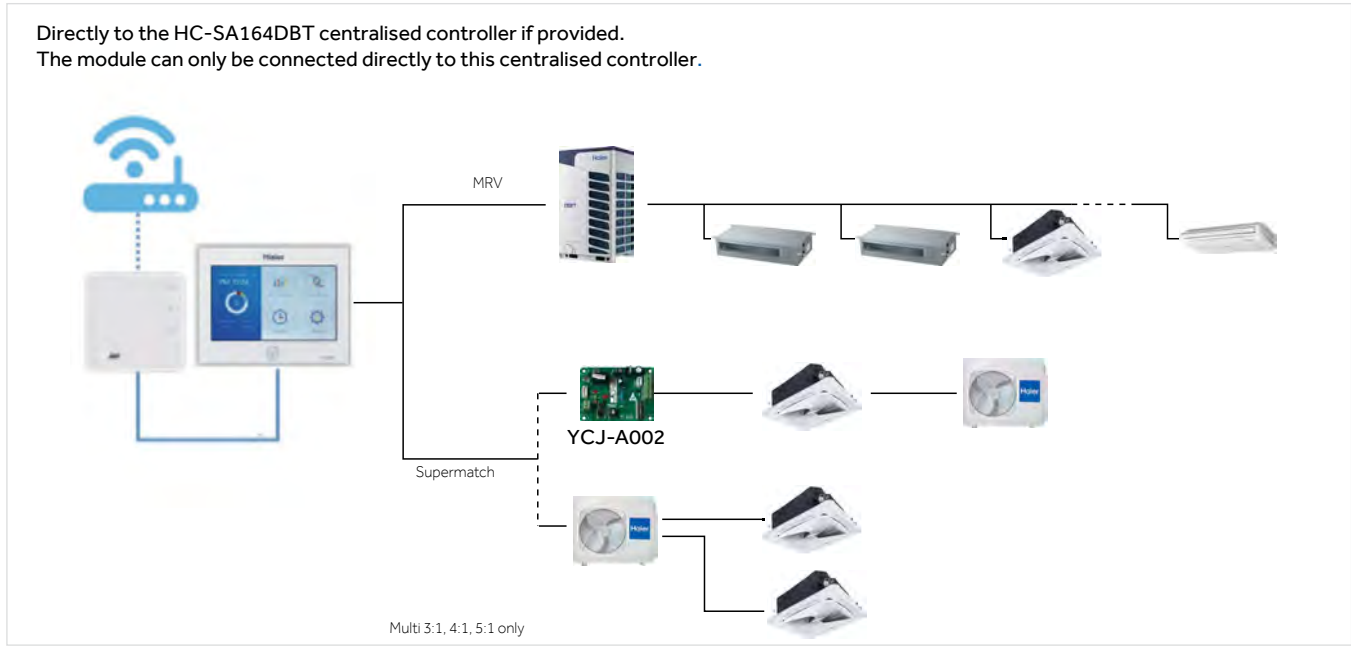

If a centralised controller OTHER THAN the HC-SA164DBT model is required locally, it is necessary to add 1 HA-MA interface for each external unit

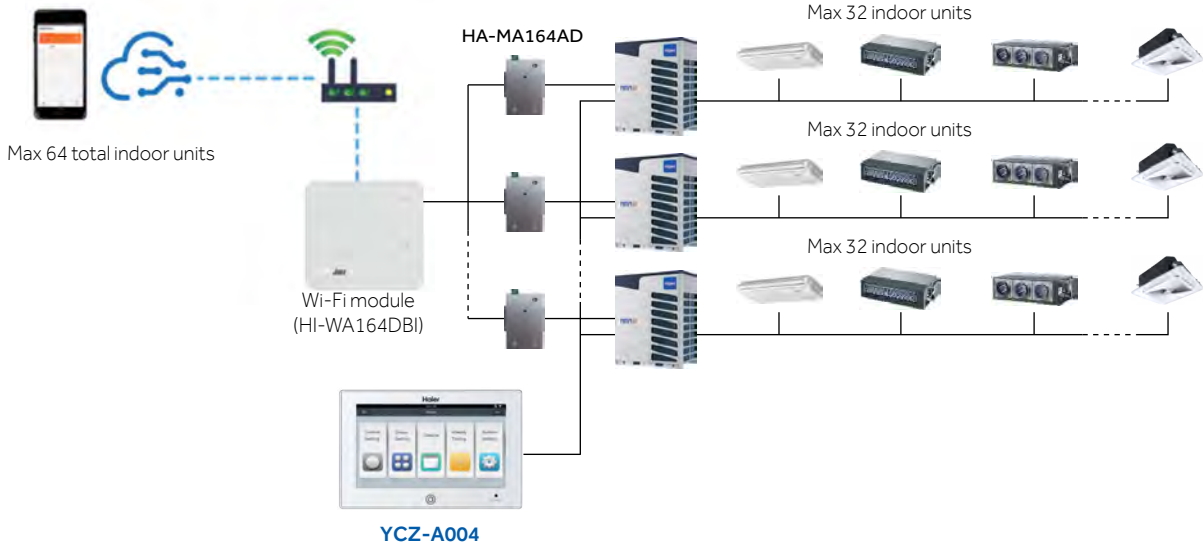

Coupled to a BMS-web or local system, always with the addition of HA-MA adapters

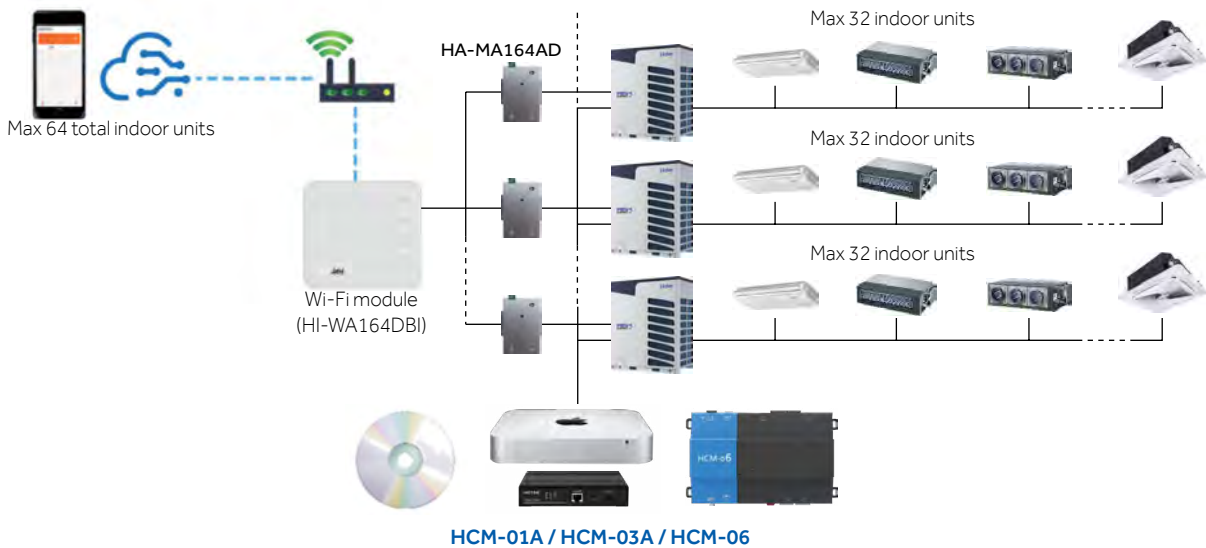

If a centralised controller is required locally and the external units are NOT 5 series, but S-series (front discharge), it is necessary to add 2 HA-MA interface for each outdoor unit, 1 for Wi-Fi and 1 for the centraliser

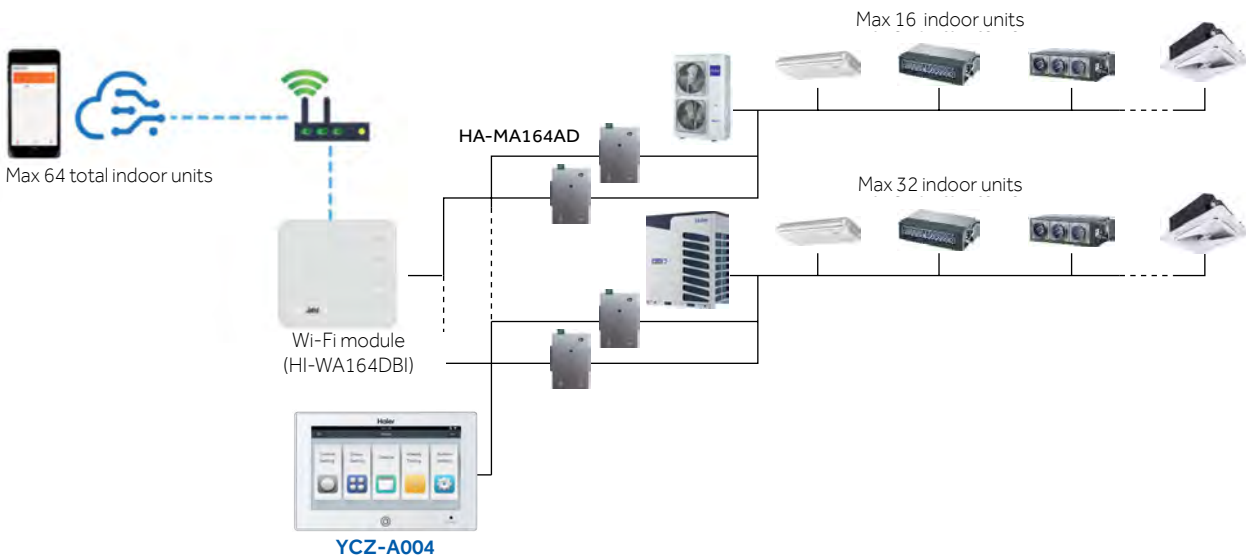

CONNECTION OF CENTRALISED CONTROLLERS DIRECTLY TO OUTDOOR UNITS

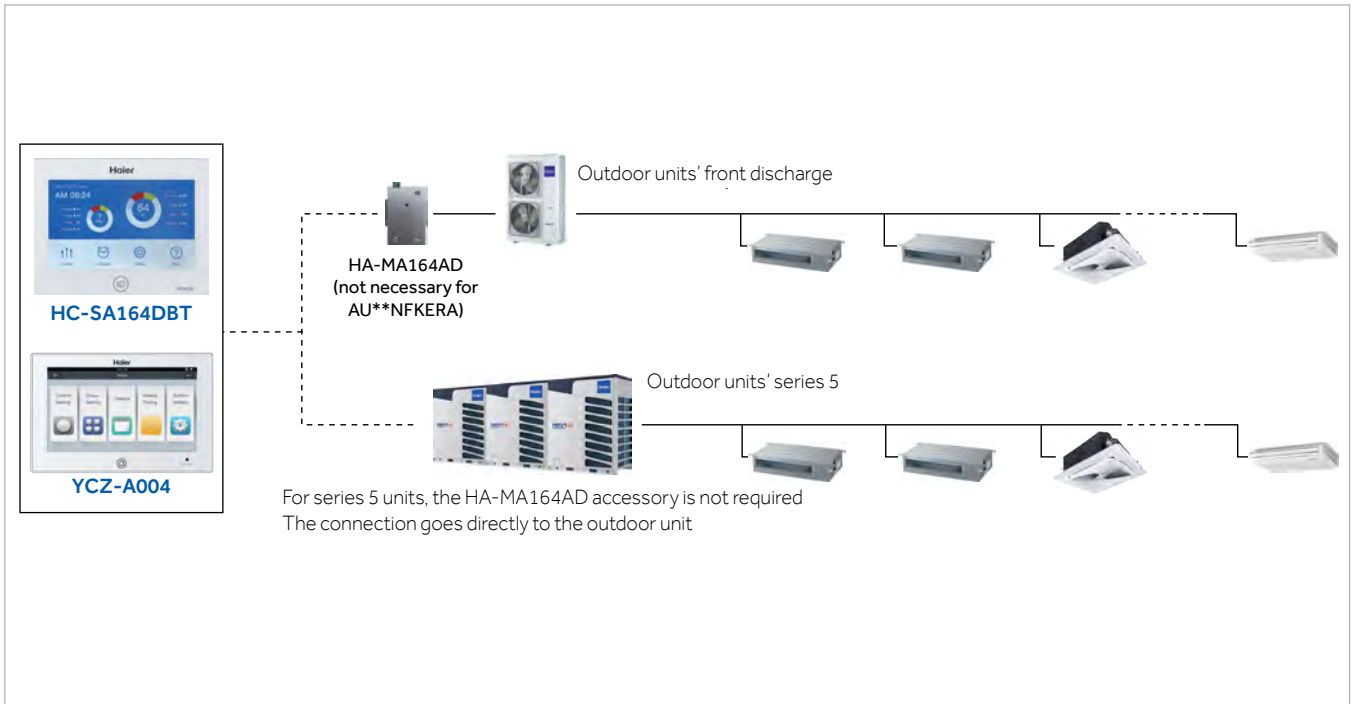

CONNECTION OF CENTRALISED CONTROLLERS IN AN INTERNAL POINT OF THE PLANT
IN THIS CONFIGURATION, THE 5 SERIES UNITS ALSO REQUIRE THE HA-MA164AD ACCESSORY

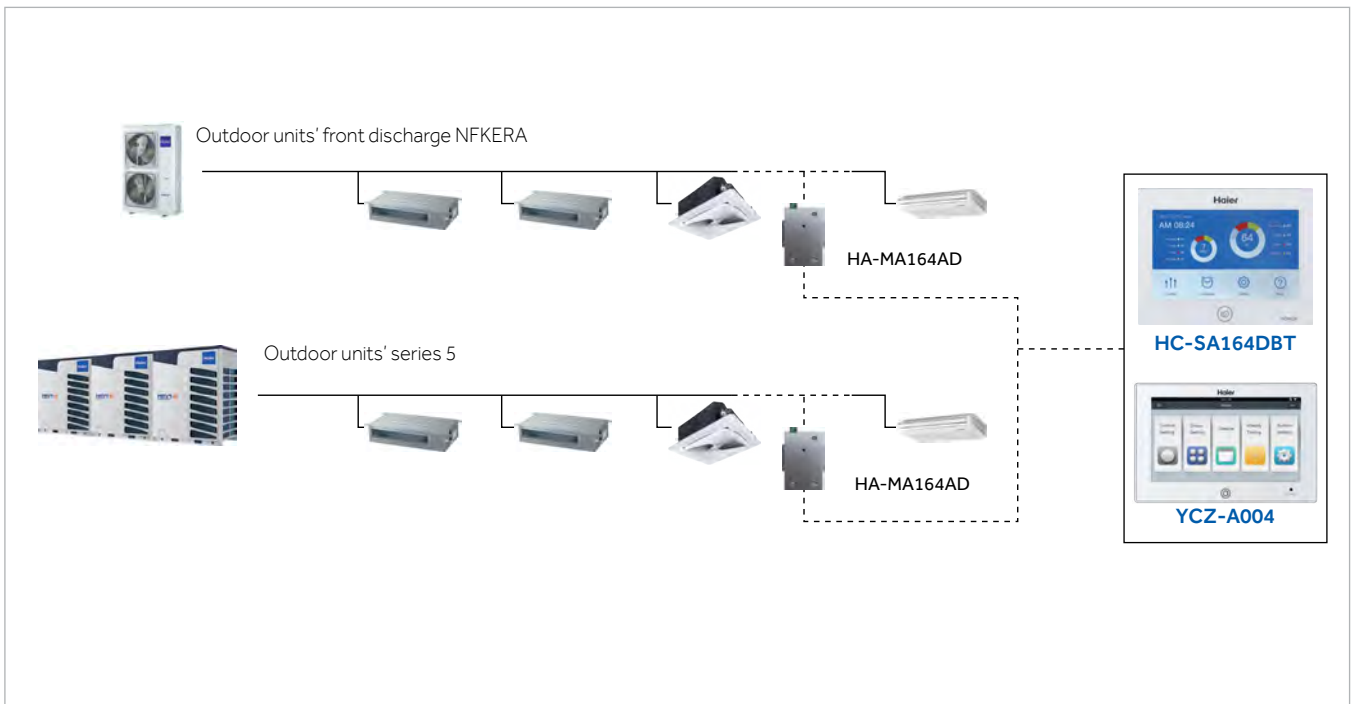

CONNECTION OF CENTRALISED CONTROLLERS IN MIXED MRV AND SUPERMATCH SYSTEMS ONLY FOR HC-SA164DBT

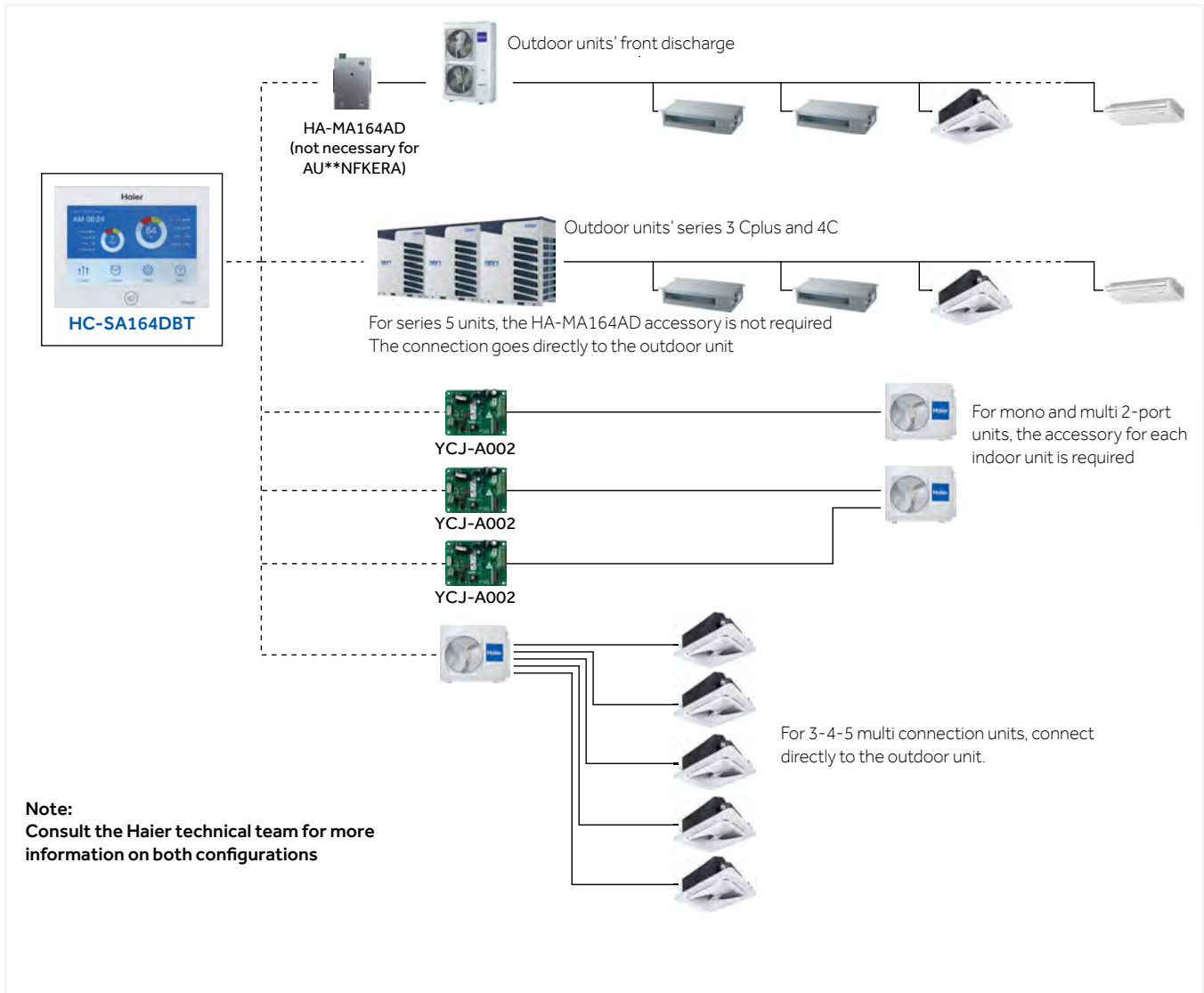

CONNECTION OF CENTRALISED CONTROLLERS TO SYSTEMS COMPOSED ONLY OF SUPERMATCH UNITS

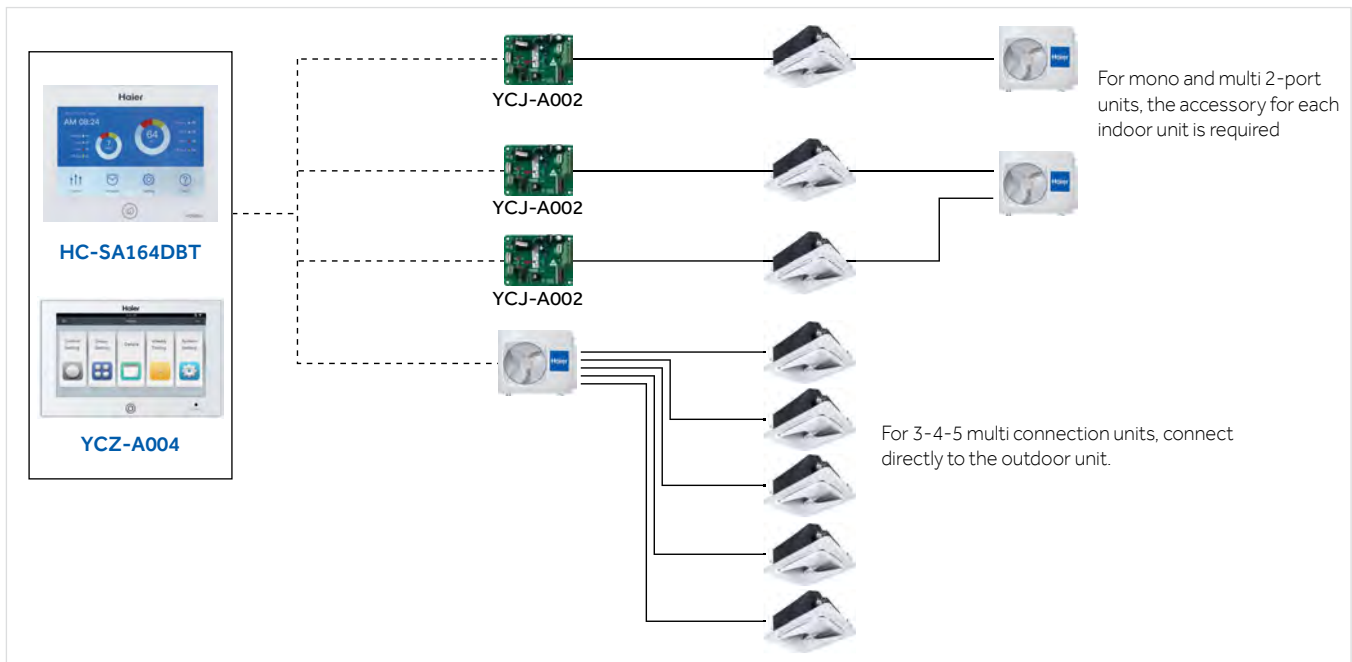

CONNECTION OF THE CENTRALIZED CONTROLLER IN MRV-SUPERMATCH MIXED SYSTEMS ONLY WITH HC-LA1CDBT

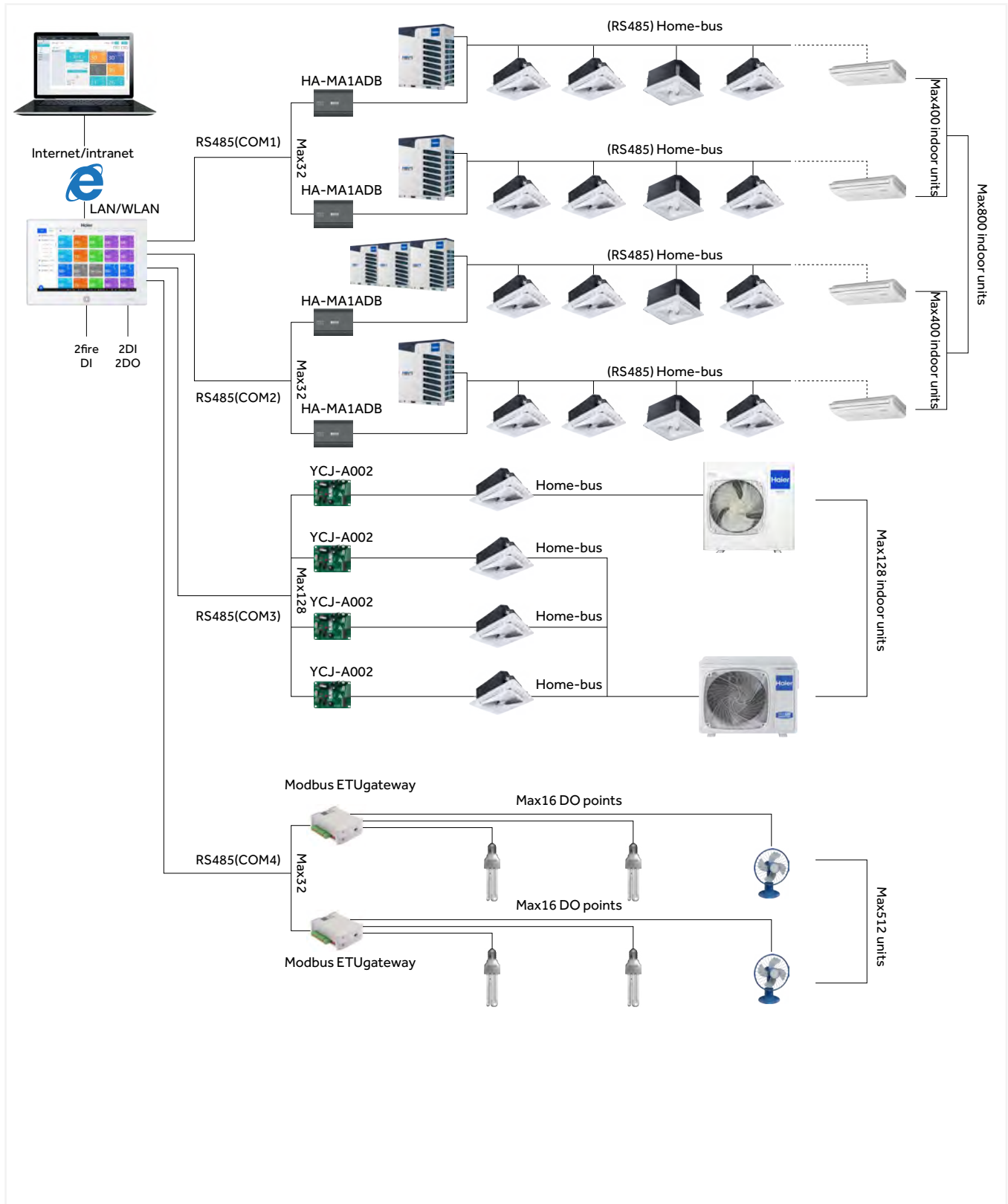

REMOTE CONTROLLERS

Haier offers different types of remote controllers to choose from based on your functional and design requirements.

YR-HQS01

- On/Off. Operation Mode. Fan speed. Temperature setting. Swing
- Turbo and Quiet
- Individual louver control for Round Flow, 4-way cassette and mini 4-way cassette
- Clock & Timer
- Health function
- Self-Clean
- Backlight



YR-HRS01

- On/Off. Operation Mode. Fan speed. Temperature setting. Swing
- Turbo and quiet
- Individual louver control for Round Flow 4-way cassette and mini 4-way cassette
- Self-Clean
- Timer
- Health function
- Backlight



RE-02

- Universal receiver for wireless remote controllers
- Required for all units installed in the concealed position, without aesthetic panel.
- Only the 2-way cassette requires the receiver even if equipped with an aesthetic panel.

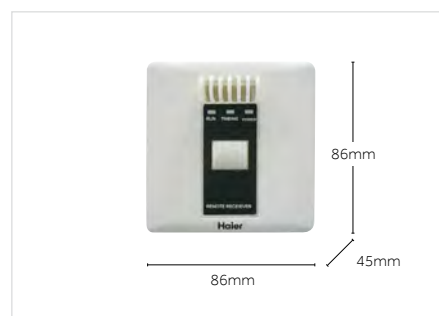

HW-BA116ABK

- On/off, temperature mode, deflectors
- Limited features ideal for hotels
- Filter cleaning interval indication
- Error control
- NOT equipped with a clock or timer
- On-board receiver for wireless infrared remote controllers, to create a double control mode (see diagram on following pages)
- Standard ambient temperature sensor. Select the ambient temperature control on the controller if you want a more accurate reading at standing height or in particular installation conditions.
- Possibility of group management with a single controller, (max 16 indoor units on a single controller), the functions and operating modes of all the indoor units connected to that controller will be identical to each other. Independent management is not possible. Each command will be replicated on all indoor units connected to that controller in the same way (see diagrams on following pages).

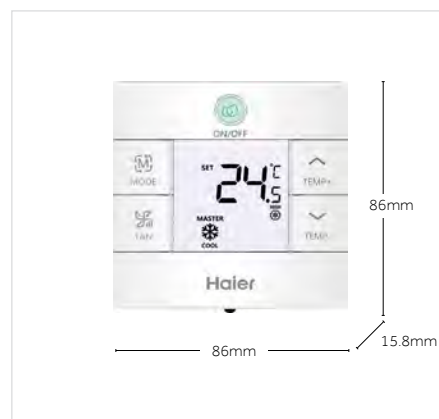

YR-E17A

- Can act as IR receiver for wireless controllers.
- On/off, temperature mode, deflectors
- Smart and compact design with only 86x86x13 mm.
- Touch keys with large backlit display
- Independent control of deflectors [only for cassette AB-MRERA-MCERA(M)]
- Daily clock and timer
- Simple installation and intuitive operation
- Error display
- PA static pressure management of indoor unit fans (on models where possible)
- Standard ambient temperature sensor. Select the ambient temperature control on the controller if you want a more accurate reading at standing height or in particular installation conditions.
- Possibility of group management with a single controller, (max 16 indoor units on a single controller), the functions and operating modes of all the indoor units connected to that controller will be identical to each other. Independent management is not possible. Each command will be replicated on all indoor units connected to that controller in the same way (see diagrams on following pages).



HW-BA101ABT

- Modern, high-intensity LED design
- Full touch black display. Automatic lighting when the keys are pressed. Black screen at rest position.
- NOT equipped with a clock or timer
- Double temperature and fan speed setting mode; a continuous infinite range or by acting on the classic + and -
- Quiet operation
- Operating mode, deflectors in on / off mode
- Possibility of group control of up to 16 indoor units with the same operating mode
- Limited features ideal for hotels
- Filter cleaning interval indication
- Error control
- Function block from centraliser
- On-board receiver for wireless infrared remote controllers, to create a double control mode (see diagram on following pages).
- Standard ambient temperature sensor. Select the ambient temperature control on the controller if you want a more accurate reading at standing height or in particular installation conditions.
- Possibility of group management with a single controller, (max 16 indoor units on a single controller), the functions and operating modes of all the indoor units connected to that controller will be identical to each other. Independent management is not possible. Each command will be replicated on all indoor units connected to that controller in the same way (see diagrams on following pages).

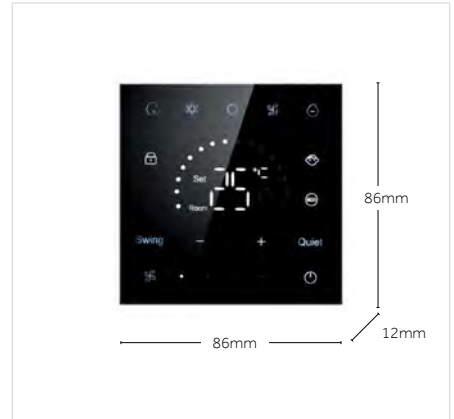

YR-E16B

- On/off, temperature mode, deflectors
- Large backlit touch screen display
- Independent control of deflectors [only cassette AB-MRERA-MCERA(M)]
- Weekly clock and timer
- Alarm history
- Fan static pressure management function
- Selection between Celsius and Fahrenheit, (+/- 0,5 °C - +/- 1 °F)
- Standard ambient temperature sensor. Select the ambient temperature control on the controller if you want a more accurate reading at standing height or in particular installation conditions.
- Possibility of group management with a single controller, (max 16 indoor units on a single controller), the functions and operating modes of all the indoor units connected to that controller will be identical to each other. Independent management is not possible. Each command will be replicated on all indoor units connected to that controller in the same way (see diagrams on following pages).



- Multi language



HI-WB201DEI (WI-FI MODULE FOR INDIVIDUAL UNITS – UNTIL STOCKS LAST)

- Ideal for small plants with stable Wi-Fi coverage that reaches all indoor units. The end user and/or user of the system must ensure their own Wi-Fi coverage that has access to the internet.
- The module must be installed and connected to the electronic board of the MRV series indoor units that you want to control with Wi-Fi.
- The user will have to download the APP "Haier Smart Air" for android, create a profile and then register each individual indoor unit following the step-by-step instructions that the APP shows on the screen.
- Control: on/off, mode, temperature, deflectors, fan speed, weekly timer, function check, generic alarm signalling.
- By carrying out a group management with the wired controllers, (max 16 indoor units on a single controller), only one Wi-Fi module will have to be installed on the Master unit which will be the one where the wired controller will be connected. In a group management with a single wired controller, the functions and operating modes of all the internal units connected to that controller will be identical to each other. Independent management is not possible. As for the wired controller, also by acting through the web with the APP, each command will be replicated on all the indoor units connected to that Wi-Fi controller / module in the same way (see diagrams on following pages).

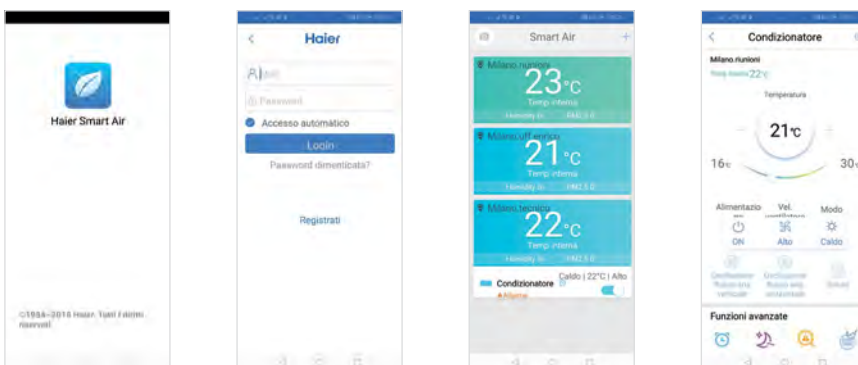

EXAMPLES OF CONNECTION OF REMOTE CONTROLLERS AND WI-FI MODULES

Example of single controller connection for independent operation of each indoor unit



Example of group controller (only for wired controllers - max 16 indoor units on a single controller)

In a group management with a single wired controller, the functions and operating modes of all the internal units connected to that controller will be identical to each other. Independent management is not possible. Each command given will be replicated on all the indoor units in the same way.

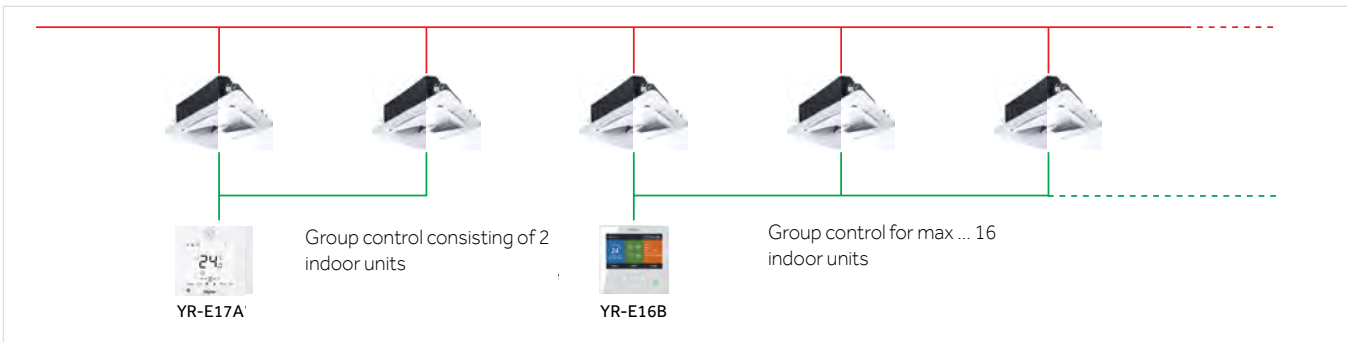

Example of a Wi-Fi module connection, for independent operation of each indoor unit

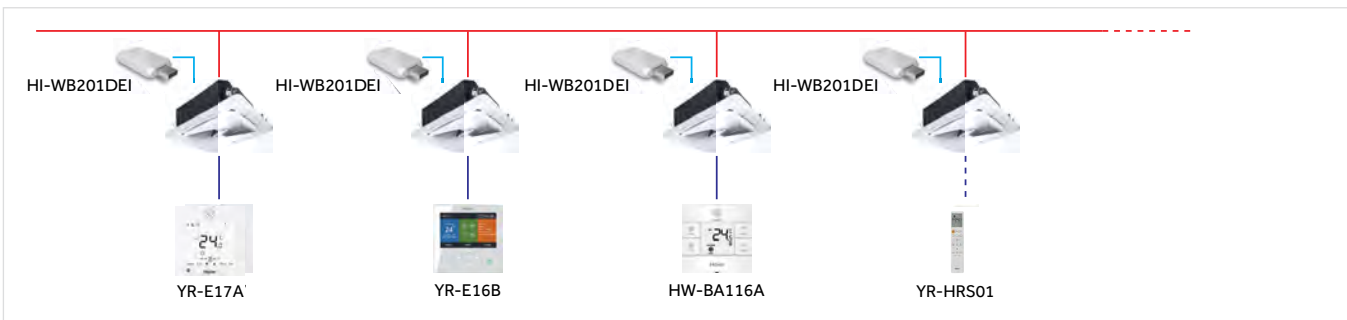

Example of group management through Wi-Fi module

Connect only one Wi-Fi module on the same Master unit, where the group wired controller is connected. Each command given through the APP, as for a group wire controller, will be replicated in the same way on all the indoor units connected to that wi-fi controller / module.

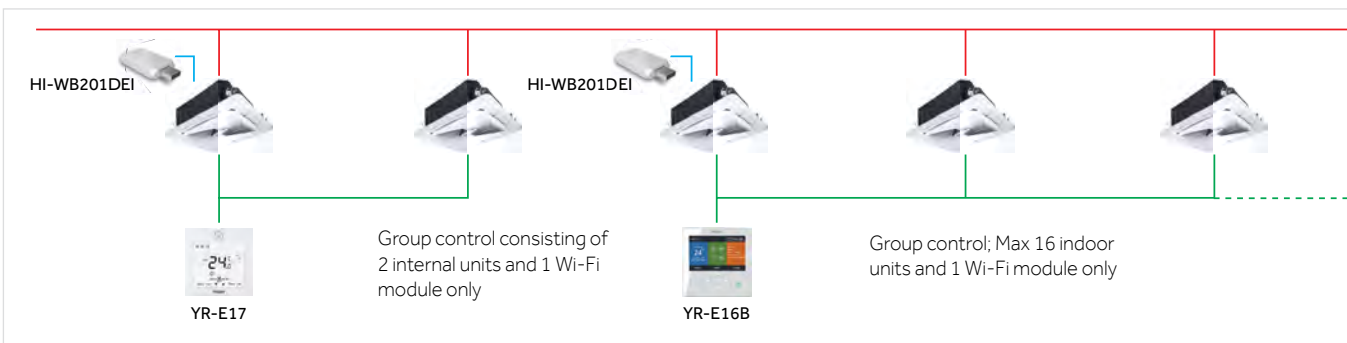

Infrared receiver on controller.

Wired controller models: HW-BA101ABT, HW-BA116ABK and YR-E17A are equipped with receiver for wireless remote controllers.

This function allows you to control an indoor unit with the wired controller and with a remote control simultaneously. (example: wired controller on the wall and remote control on the desk or on the bedside.)



INTEGRATED MANAGEMENT SYSTEM FOR MEDIUM AND LARGE BMS PLANTS



HCM-01A LOCAL MANAGEMENT SYSTEM FOR MEDIUM-SIZED PLANTS

- MRV plant supervision and management system for local use on PC.
- RS-485 protocol converter in RS-232 via USB adapter for local use on PC.
- Control max 400 units and/or maximum 32 independent cooling circuits
- Each cooling circuit requires HA-MA164AD adapter (except for outdoor unit series 5)
- Management of all system parameters by zones / groups / individual units, weekly and monthly timers, error management and alarm history.
- Clear and intuitive visualisation software
- **DOES NOT allow management via web/Internet**
- The software works on Windows platform (7 32/64 bits- 8 Pro - 10 Pro)
- The software has a license for use on a single PC. If you plan to use on two or more PCs, you need to purchase 2 or more licenses
- Possibility of accounting for electricity consumption. Providing IGU-02 adapters instead of HA-MA164AD. One IGU-02 for each cooling circuit, also for series 5 outdoor units. For each cooling circuit / IGU-02, a "Wattmeter / pulse generator" must be provided which detects the energy absorption of the outdoor units and proportionally generates counting pulses that the IGU-02 adapter receives and transforms into values to be managed and visualised by the software (**the pulse generator wattmeter / ammeter is not supplied by Haier, as it must be selected and sized according to the power of the plants**).



INDICATIVE DIAGRAM FOR LOCAL MANAGEMENT WITH HCM-01A

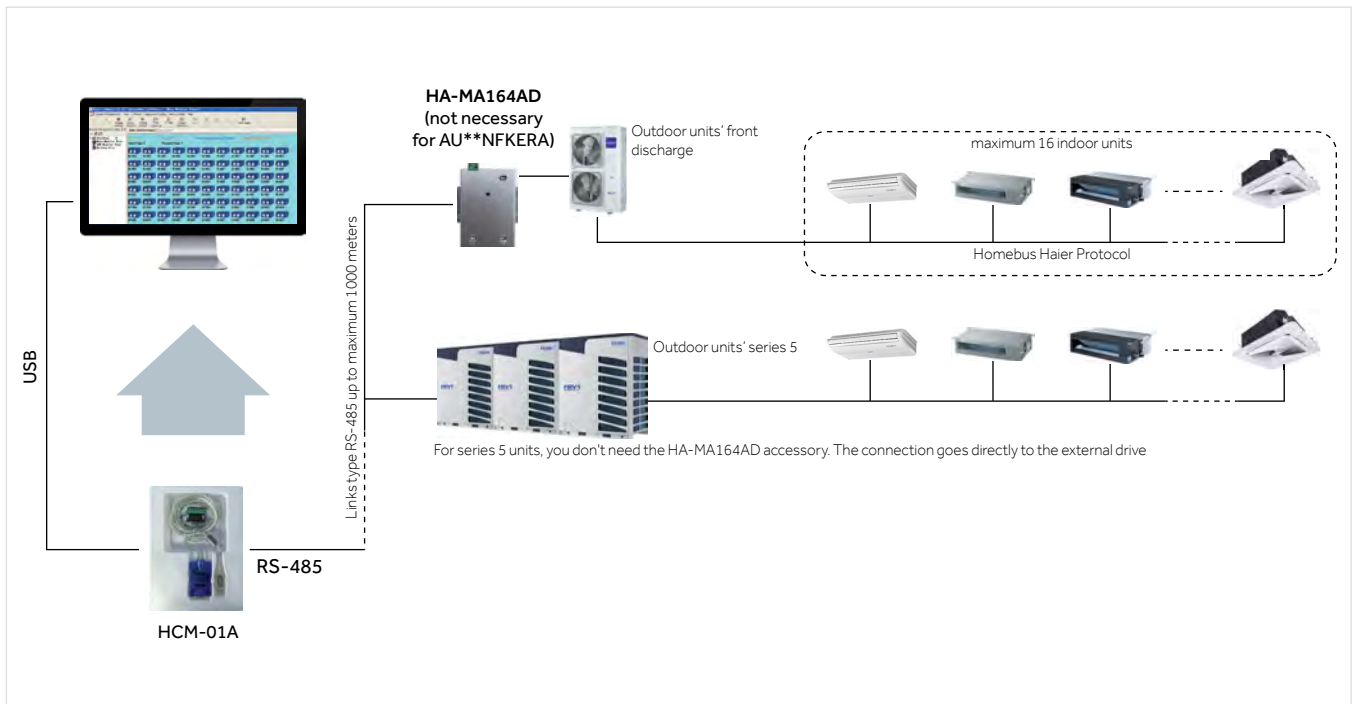

INDICATIVE DIAGRAM FOR LOCAL MANAGEMENT WITH HCM-01A AND CONSUMPTION ACCOUNTING

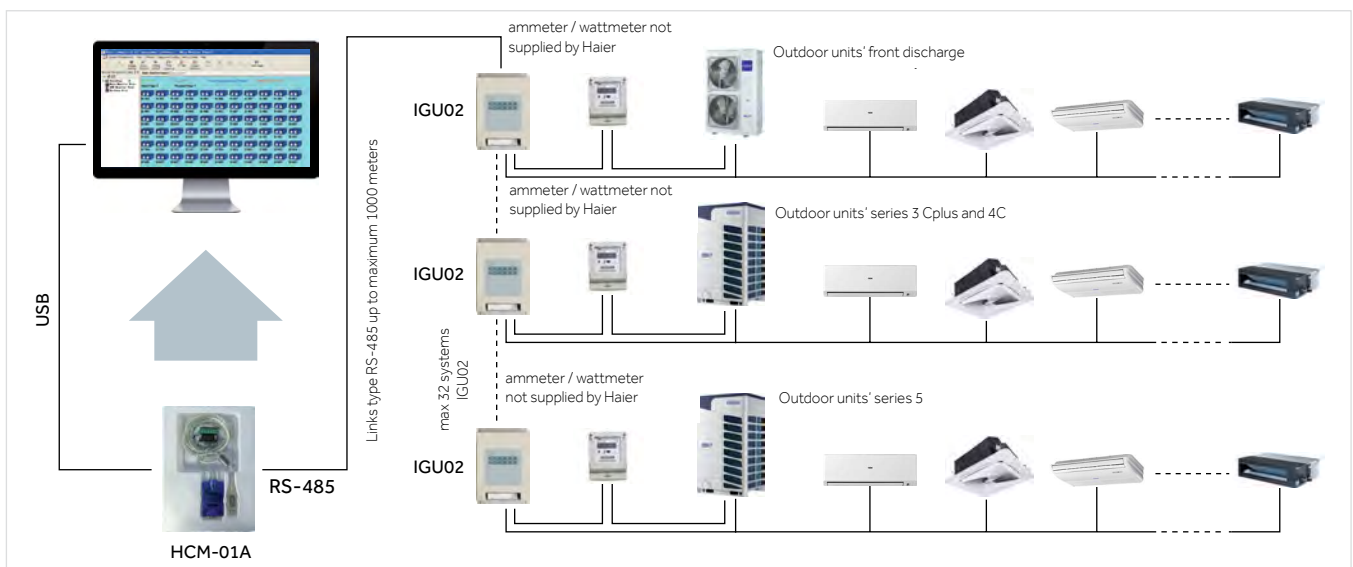

HCM-06 MEDIUM PLANT MANAGEMENT SYSTEM WITH WEB / INTERNET CONTROL FUNCTION INTEGRATED SYSTEM FOR PLANTS UP TO 250 INTERNAL UNITS

- PC or remotely via web/internet.
- Each HCM-06 adapter is equipped with a web browser integrated with a specific IP address. Requires a connection to a network with internet access, via ethernet cable. Once configured, anywhere in the world simply enter the IP address supplied with the HCM-06 in the web search engine **Google Chrome** to access the system to be controlled. Access to specific system management is protected by multi-level passwords.
- Possibility of communication with systems, not supplied by Haier, through the BACnet - IP protocol.
- Max 250 indoor units that can be controlled with the HCM-06 model.
- Up to a maximum of 32 independent cooling circuits can be controlled. Each cooling circuit requires HA-MA164AD adapter (except for outdoor unit series 5)
- Management of all system parameters by zones / groups / individual units, weekly and monthly timers, error management and alarm history. Clear and intuitive visualisation software
- Possibility of accounting for electricity consumption. Providing IGU-02 adapters instead of HA-MA164AD. One IGU-02 for each cooling circuit, also for series 5 outdoor units. For each cooling circuit / IGU-02, a "Wattmeter / pulse generator" must be provided which detects the energy absorption of the outdoor units and proportionally generates counting pulses that the IGU-02 adapter receives and transforms into values to be managed and visualised by the software.
(the pulse generator wattmeter / ammeter is not supplied by Haier, as it must be selected and sized according to the power of the plants).



ILLUSTRATIVE DIAGRAM FOR MANAGEMENT VIA WEB WITH HCM-06

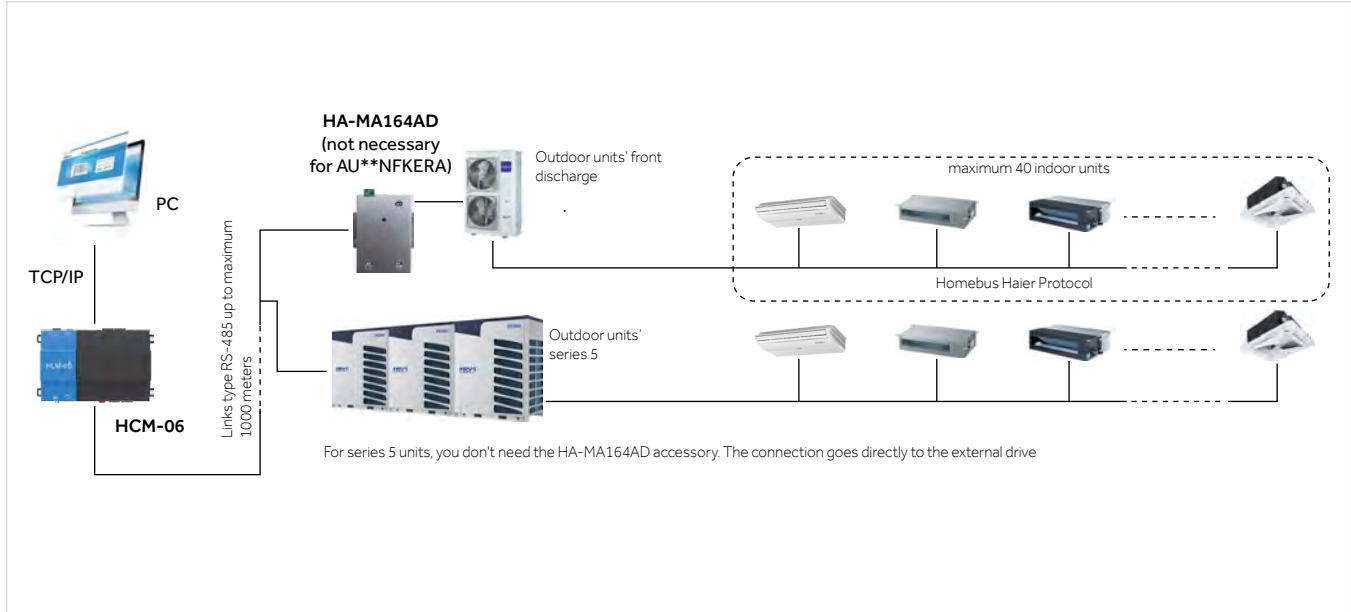

ILLUSTRATIVE DIAGRAM FOR MANAGEMENT VIA WEB WITH HCM-05 WITH CONSUMPTION ACCOUNTING

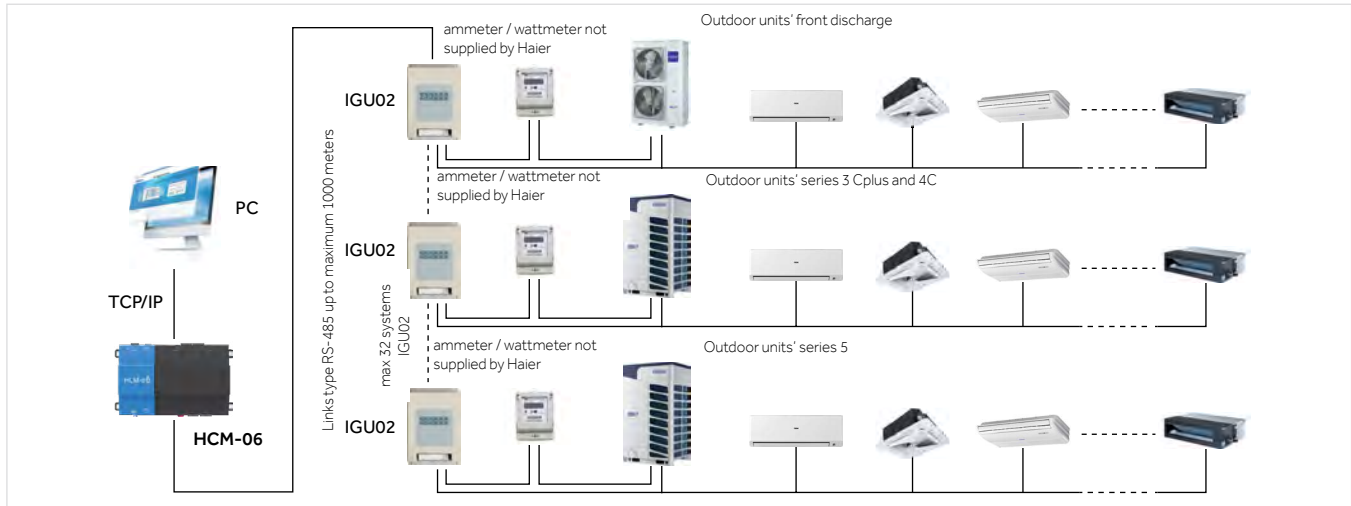

The data in this catalogue is purely indicative as the data may vary. Please be advised to check the accuracy of the data with the supplier before purchasing products.



Monitoring

Independent control of up to 500 indoor units

- Mode, temperature, ventilation, deflectors
- Blocking of user functions
- Controlling of blocking levels
- An icon with all the information for each individual unit

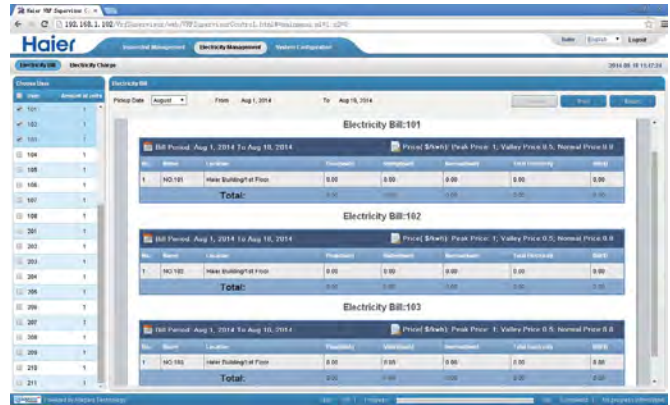

Energy consumption report for each unit

- Data store
- Possibility of defining different costs by usage ranges
- Preview and print the results
- Comparison of operating costs over time

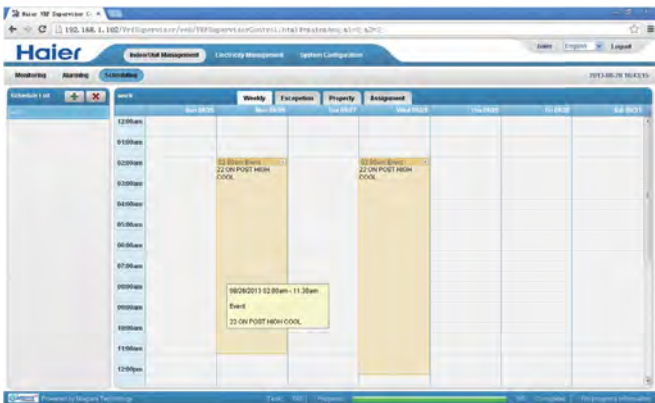

Programming

- Weekly and monthly schedule graph
- Free configuration
- Defining sample programmes



Zone control

- Creation of zones for management that can be customised according to the requests

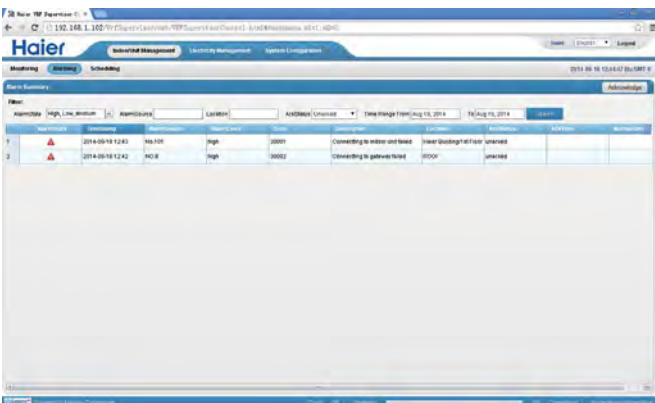

Alarm management

- History of alarm messages
- Detail of every single alarm

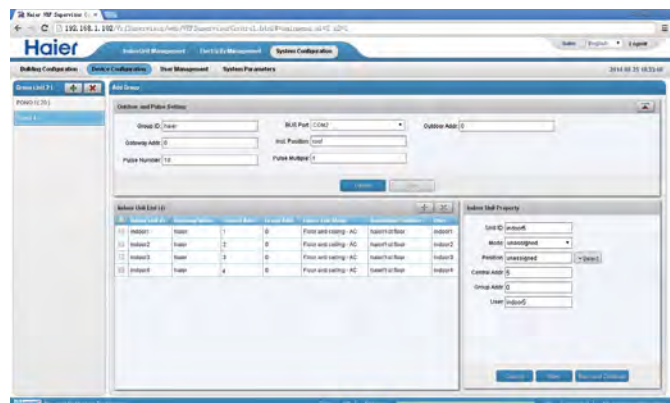

System configuration

- Building-based configuration
- Equipment configuration
- Management of access levels
- Management of parameters

HCM-03A LARGE PLANT MANAGEMENT SYSTEM WITH WEB/INTERNET CONTROL FUNCTION INTEGRATED SYSTEM FOR PLANTS UP TO 1500 INDOOR UNITS

- Local control over the network from PC or remotely via web/internet.
- Each HCM-03A adapter is equipped with a web browser integrated with a specific IP address. Requires a connection to a network with internet access, via ethernet cable. Once configured, anywhere in the world simply enter the IP address supplied with the HCM-03 in the web search engines **Google Chrome or Firefox** to access the system to be controlled. Access to specific system management is protected by multi-level passwords.
- Possibility of communication with systems, not supplied by Haier, through the BACnet - IP, Modbus protocol.
- Max 1500 controllable indoor units.
- Up to 20 independent cooling circuits can be connected to one of the four available ports, in order to obtain a system that provides a maximum of 80 circuits. Each cooling circuit requires HA-MA164AD adapter (except for outdoor unit series 5)
- Management of all system parameters by zones / groups / individual units, weekly and monthly timers, error management and alarm history. Clear and intuitive visualisation software
- Possibility of accounting for electricity consumption. Providing IGU-02 adapters instead of HA-MA164AD. One IGU-02 for each cooling circuit, also for series 5 outdoor units. For each cooling circuit / IGU-02, a "Wattmeter / pulse generator" must be provided which detects the energy absorption of the outdoor units and proportionally generates counting pulses that the IGU-02 adapter receives and transforms into values to be managed and visualised by the software. **(the pulse generator wattmeter / ammeter is not supplied by Haier, as it must be selected and sized according to the power of the plants).**
- Possibility to insert the building layout as a file in the HCM-03A system to create specific command buttons within the reference rooms via the loaded floor plan.
- Technology developed in collaboration with **MAC mini**.



ILLUSTRATIVE DIAGRAM FOR MANAGEMENT VIA WEB WITH HCM-03A.

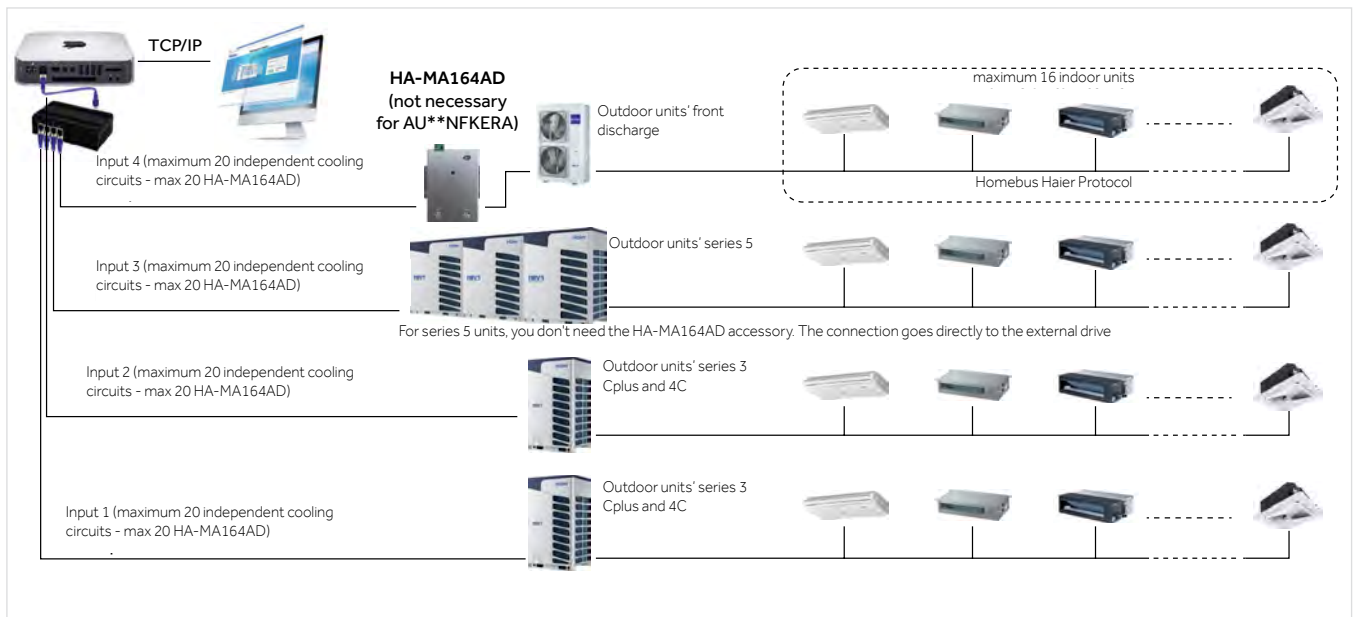

ILLUSTRATIVE DIAGRAM FOR MANAGEMENT VIA WEB WITH HCM-03A WITH CONSUMPTION ACCOUNTING

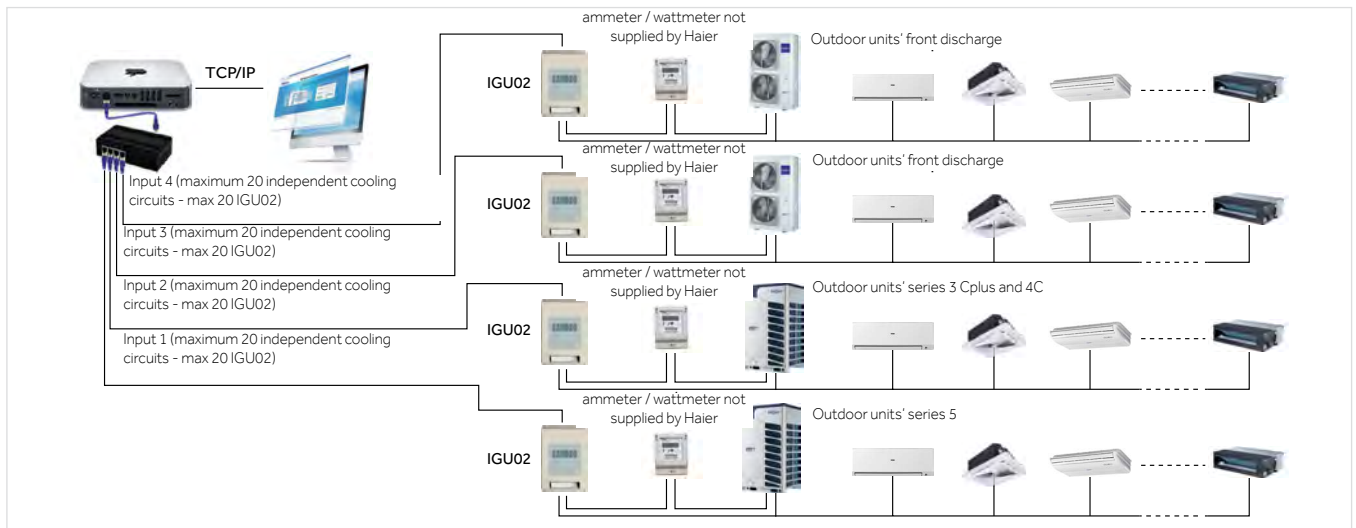

SIMPLE AND INTUITIVE NAVIGATION

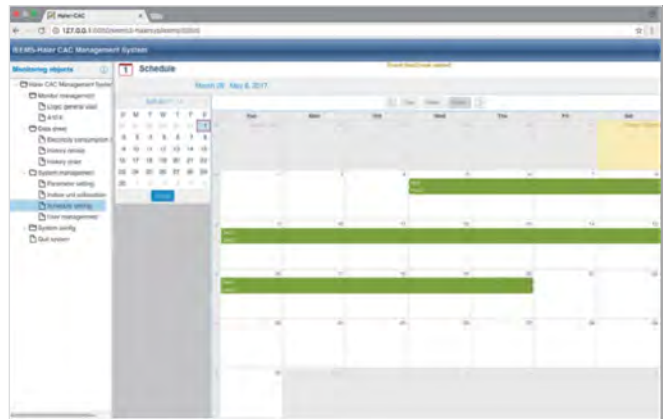
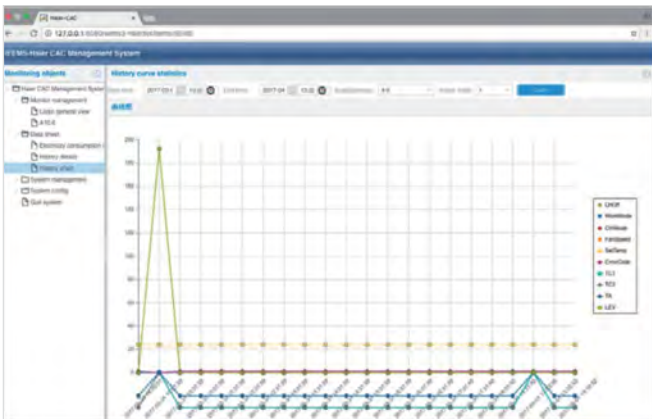

Building layouts can be inserted as a file in the HCM-03A system to configure by positioning the specific indoor unit and the dedicated controller. The creation of specific command buttons inside the premises allows direct management of the floor plan, simulating reality more accurately which makes everything more intuitive and simple.



HA-MA164AD (MODBUS ADAPTER)

- Haier to MODBUS protocol converter (not required for series 5 outdoor units)
- Each cooling circuit requires 1 converter
- 1 converter can handle max 64 indoor units on single cooling circuit
- Power supply transformer included
- It is not possible to account for electricity consumption



IGU02 (ADAPTOR TO ACCOUNT FOR CONSUMPTION)

- Haier protocol converter to RS-485 to be used in conjunction with BMS systems: HCM-01A / 03A / 05-05A, necessary if you want to monitor the electrical consumption of MRV systems.
- Each IGU-02 can control up to a maximum of 40 indoor units
- You need an IGU-02 for each cooling circuit, even for outdoor 5 series.
For each cooling circuit / IGU-02, a "Wattmeter / pulse generator" must be provided which detects the energy absorption of the outdoor units and proportionally generates counting pulses that the IGU-02 adapter receives and transforms into values to be managed and visualised by the software (**the pulse generator wattmeter / ammeter is not supplied by Haier, as it must be selected and sized according to the power of the plants**).

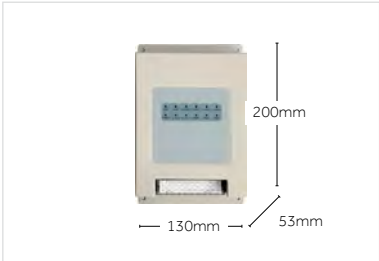

IGU07 (LONWORKS ADAPTER)

- Modbus > Lonworks protocol converter
- Each IGU-07 can control only 1 cooling circuit and up to a maximum of 32 indoor units
- The cooling circuit connected require adapter HA-MA164AD (except for series 5 outdoor units)
- **The IGU07 adapter does not have a power transformer, therefore it is necessary to have a 24 Volt DC power supply (24 VDC) fitted by the installer.**
- It is not possible to account for electricity consumption

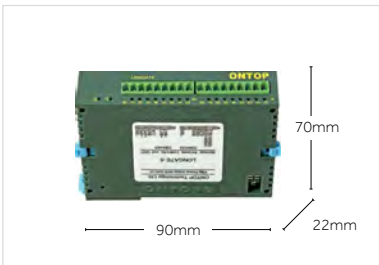

HA-AC-KNX (KNX ADAPTER)

- Haier to KNX protocol converter
- Requires HA-MA164AD adapter
- 3 available models, up to 8, up to 16 and up to 64 controllable indoor units (HA-AC-KNX-8, HA-AC-KNX-16, HA-AC-KNX-64)
- Does not require power supply



HCM-04

- BACnet gateway, convert modbus rtu to BACnet ip
- Max.128 indoor units/ 4 systems can be controlled. Max. 32 indoor units for one system
- MRV 5 and upgraded MRV SII (8/10/12HP) can connect directly with HCM-04.
- Other MRV systems require IGU02 or HA-MA164AD
- BTL certificate

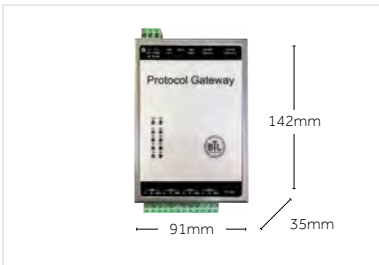

MTC-001

Application Scenario:

- a. The multi tenant site using separate circuit breaker for each indoor unit
- b. The hotel room using key-tag system which cuts off the power of indoor unit directly
- When it is detected that any connected indoor unit is forcibly cut off, the MTC-001 provides DC power to the indoor PCB to ensure that the indoor unit maintains standby mode: the EEV is turned off and the control signal is blocked to prevent the system from alarming
- Note: If there is power or communication failure in the indoor computer board, MTC-001 cannot be prevented and detected



ADDRESS SETTING AND CHECKING TOOL YR-NS

- On/Off, Mode, Fan speed, Temperature setting, Swing
- IDU address checking
- IDU address setting



EXAMPLES OF CONNECTION ADAPTERS

HA-MA164AD, MODBUS ADAPTER

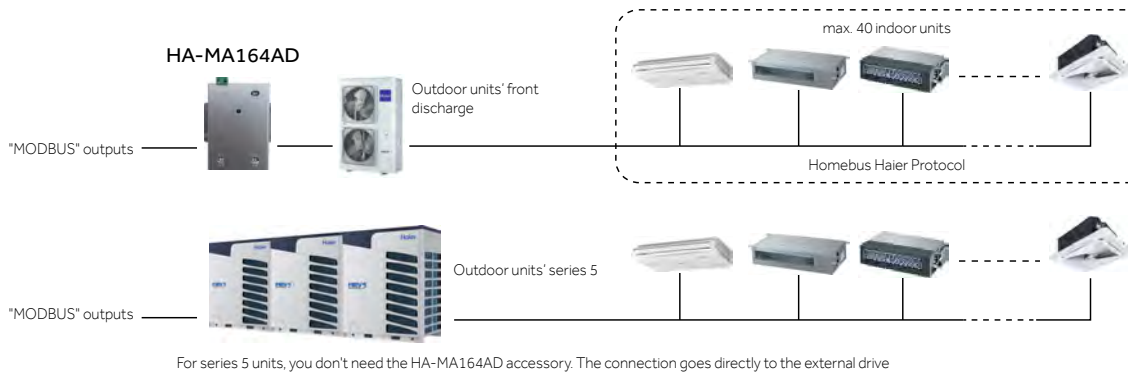

IGU-02 – ADAPTER FOR ACCOUNTING

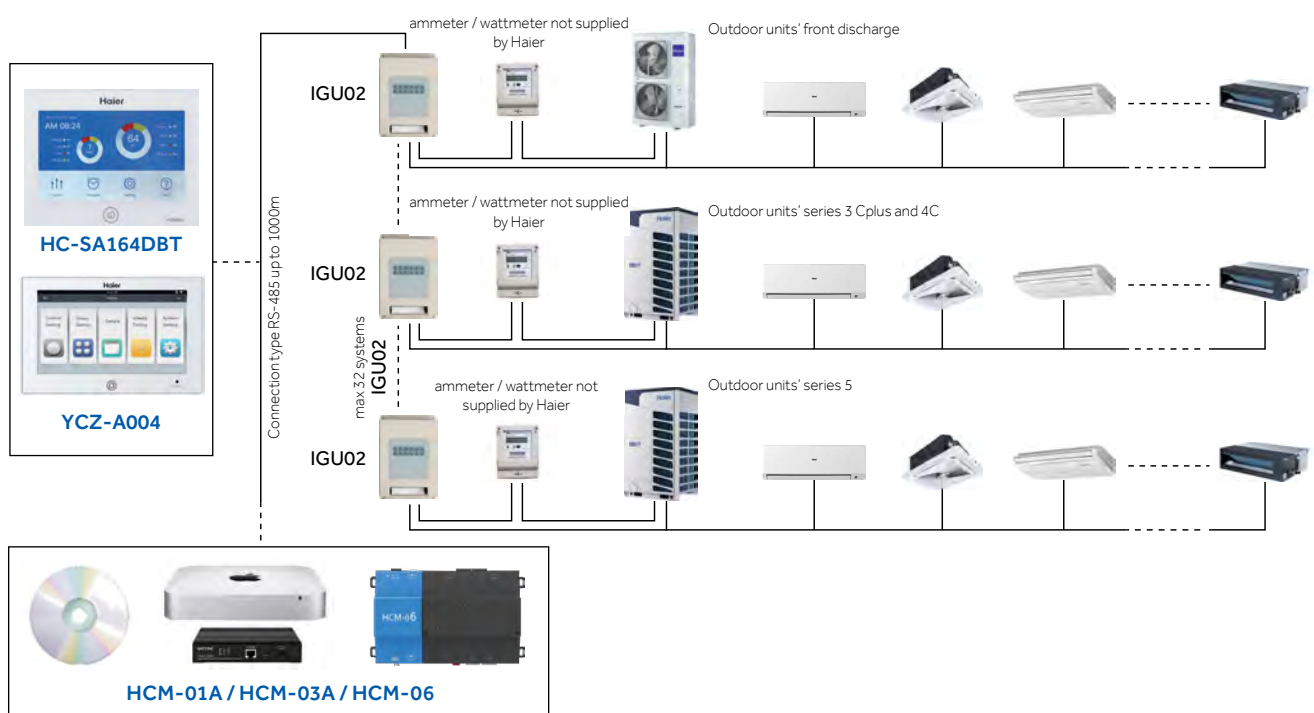

MTC-001

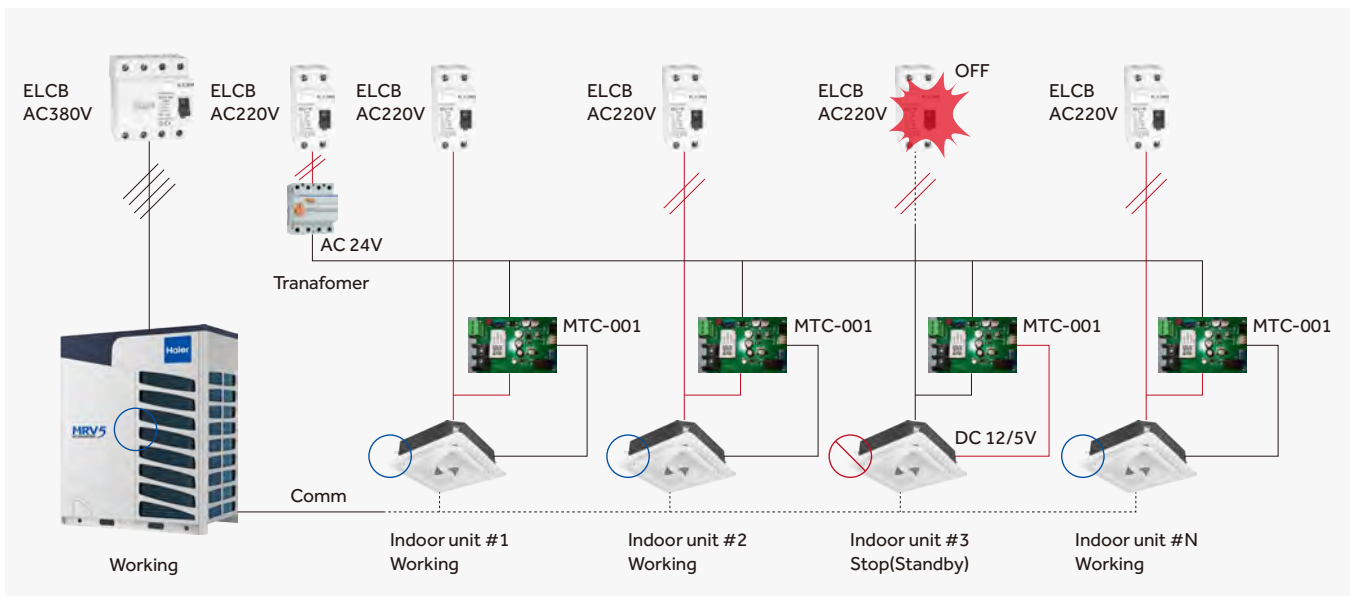

IGU-07 ILLUSTRATIVE CONNECTION SCHEME FOR LONWORKS SYSTEMS

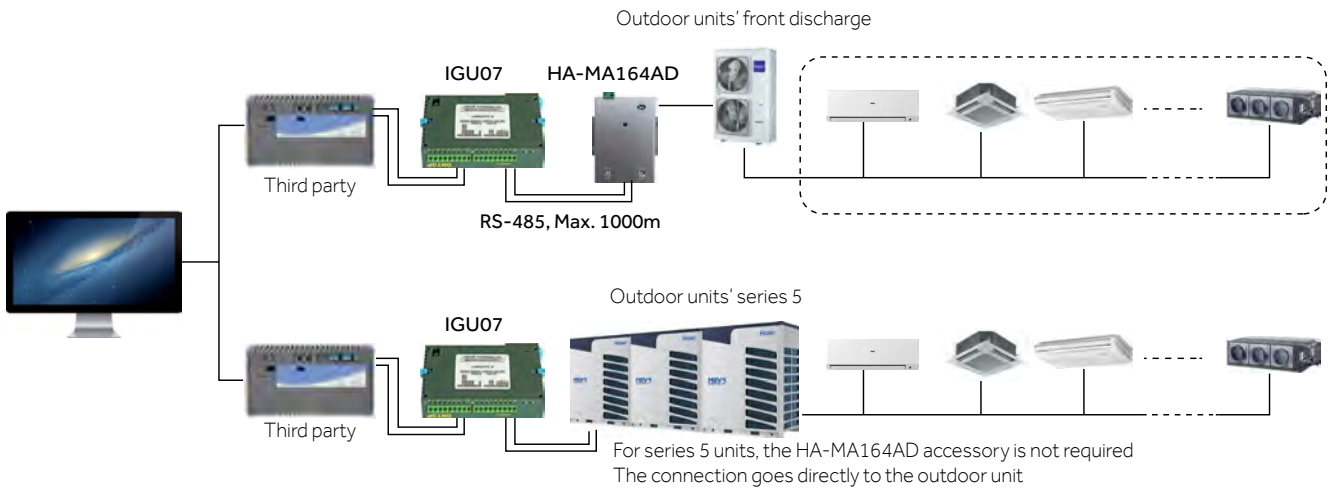

HA-AC-KNX - KNX ADAPTER

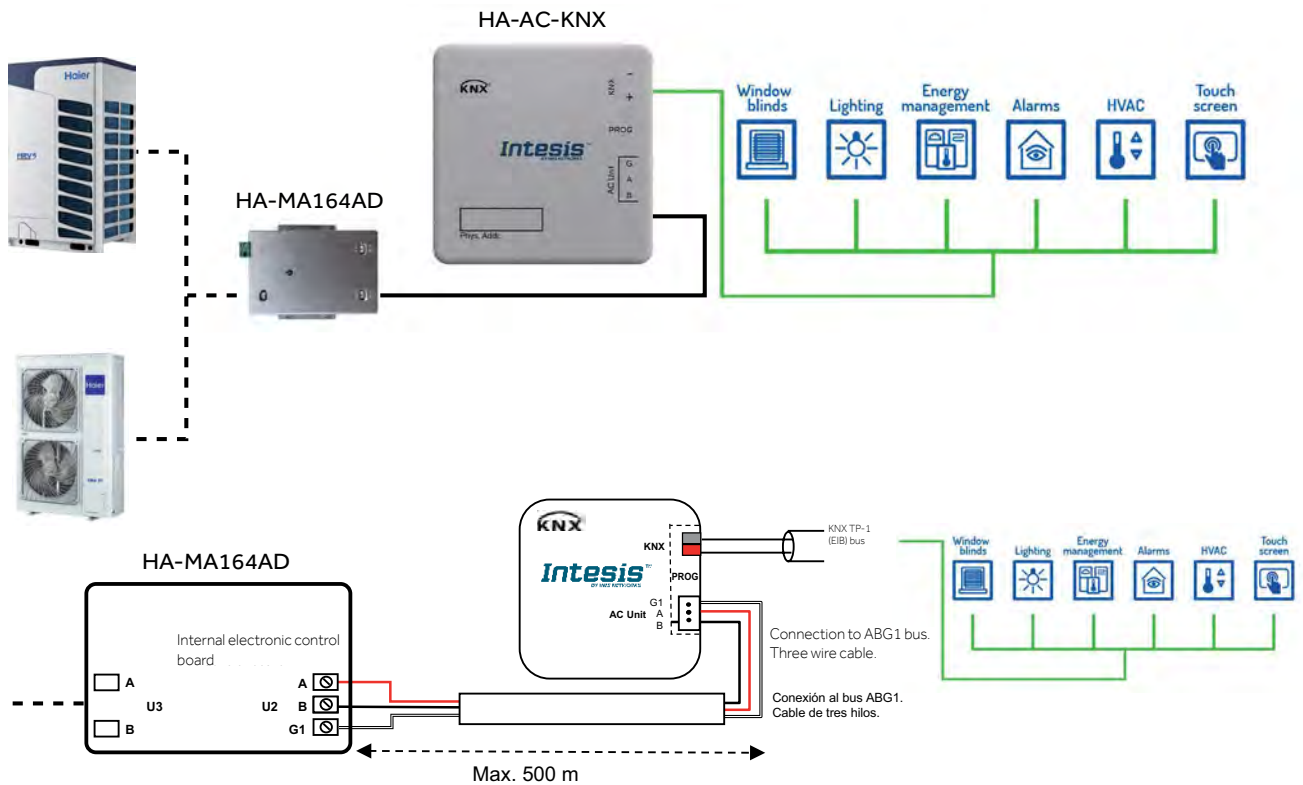

Haier

HVAC Solutions

Professional, Smart &
Healthy Air Solutions

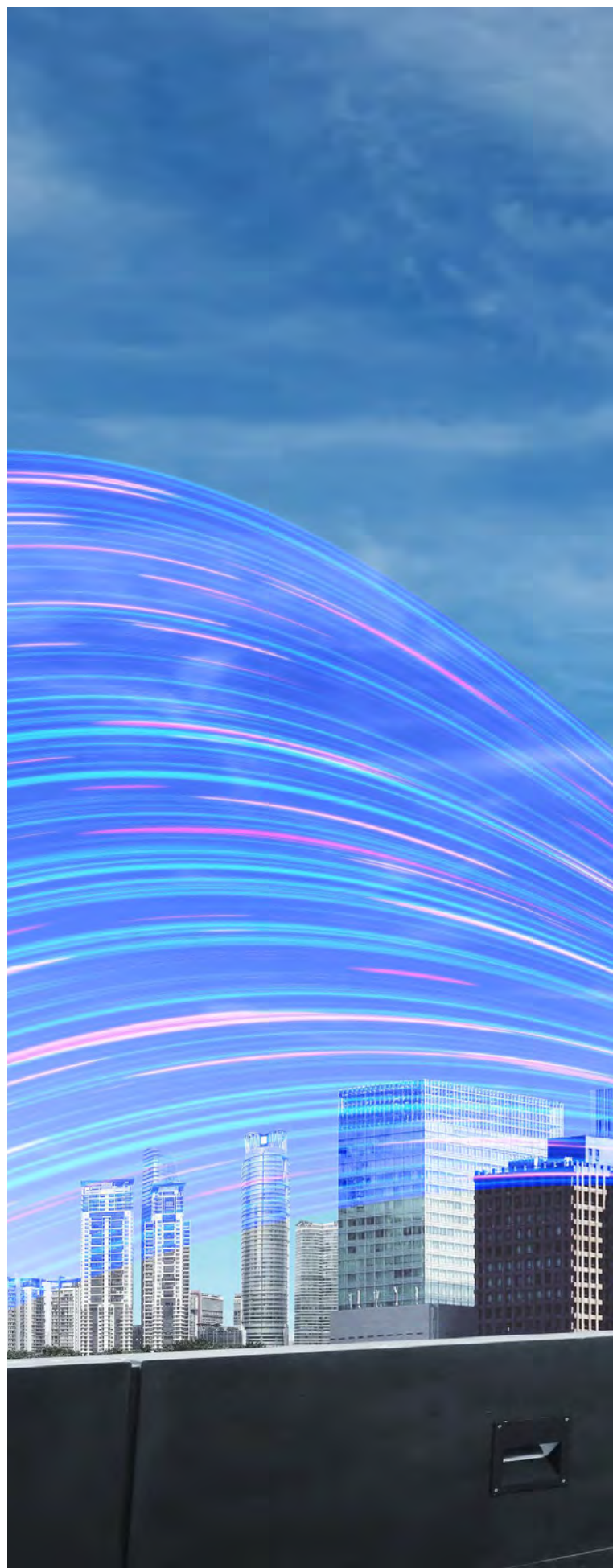

Haier HVAC European HQ

Via Marconi, 96. 31020
Revine Lago (TV) - Italy
haierhvac.eu