

**Haier**  
HVAC Solutions

Professional, Smart &  
Healthy Air Solutions



# EXPERT NORDIC

Everything you need from an Expert  
Low Ambient Heating Series

[Haierhvac.eu](http://Haierhvac.eu)

Everything you  
need from  
an Expert.



The new  
**EXPERT NORDIC**   
Air Conditioning range.

**-30° Heating** and **A+++** rating,  
with easy maintenance, offering  
**quick disassembly** and  
complete cleaning.

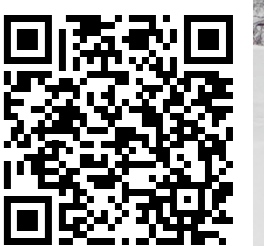

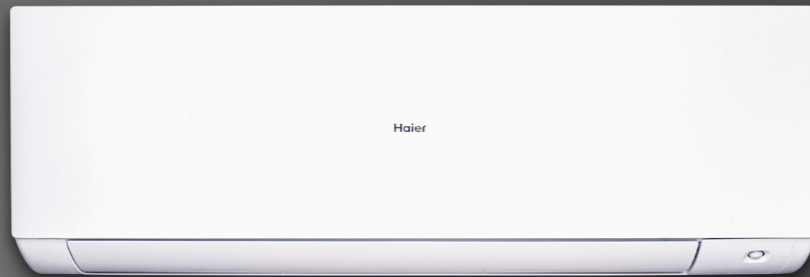

A+++ / A+++

## Everything You Need From An **EXPERT NORDIC**

The New EXPERT NORDIC Air Conditioning range is available in 2.5kW - 3.5kW sizes in a modern matt finish, with energy efficiencies of A+++ / A+++. Its packed with great market leading features such as hOn Wi-Fi as standard for complete flexibility, the New UVC Pro sterilisation function which inhibits the SARS CoV-2 virus, Eco Sensor, and much more.

The EXPERT NORDIC enables simple and easy cleaning of the internal fan where dust and bacteria can build up over time. Airflow in the room is further enhanced through Coanda Plus & 3D Air Flow technology for even air distribution and comfort.

The range includes for the first time the new UVC Pro module which generates plasma to aid sterilisation for a healthier, cleaner, room air environment. The new UVC Pro has been independently tested by Texcell to inhibit SARS-CoV-2 at the unit to 99.991% effectiveness. The UVC Pro is also fast acting and was tested to achieve 85.208% effectiveness in a room space of 6.7m<sup>3</sup> in only four hours.

## Key Features

-30°C  
HeatingFreeze-Prevention  
TechnologyCompressor Preheating  
TechnologyDouble O  
shaped Valve

### ULTIMATE POWER

Our smart design driven by dedicated R&D enabled us to upgraded key components such as, the compressor, fan and heat exchanger which significantly improved the heating efficiency to a stable A+++ to provide ultimate comfort at extreme -30°C low outdoor ambient temperatures.

### SMART DEFROSTING

Smart defrosting technology enables the EXPERT NORDIC to operate smoothly under low ambient temperatures. Defrosting under an impressive -35° outdoor ambient temperature.

# The **EXPERT NORDIC** comes with premium features

## DELIVERING CLEAN AIR

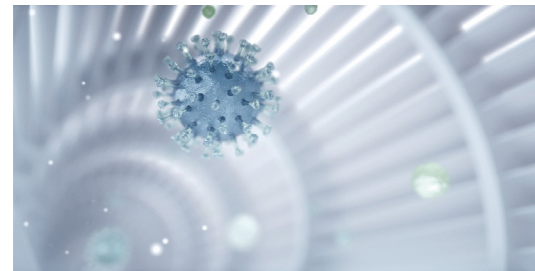
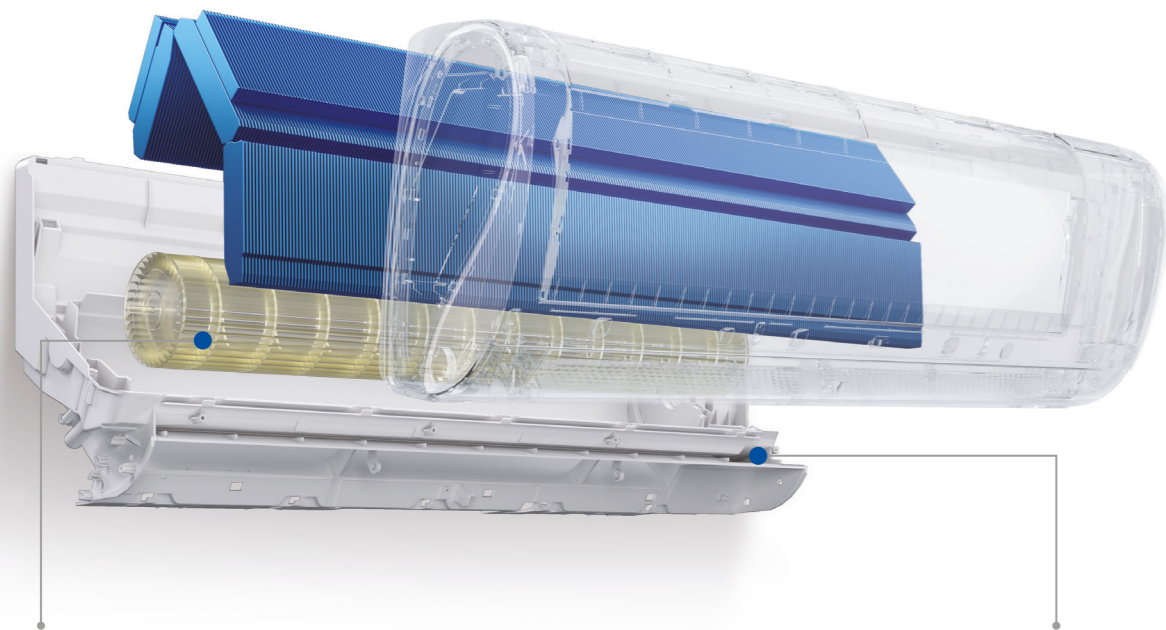

### EASY-TO-CLEAN

Easy access to the fan and filter allows for deep cleaning to ensure healthy clean airflow



### SELF-HYGIENE

The surface area of the heat exchanger of all units in the residential range is coated with silver ions to prevent the creation of mould and bacteria.



- 30°C Heating
- Freeze-Prevention Technology
- Compressor Preheating Technology
- Eco Sensor
- I Feel
- Coanda Plus
- Wi-Fi Control
- UVC Pro
- Self Clean
- Easy Installation
- 2-Way Piping Design
- Easy to Disassemble

## DELIVERING HEALTHY AIR

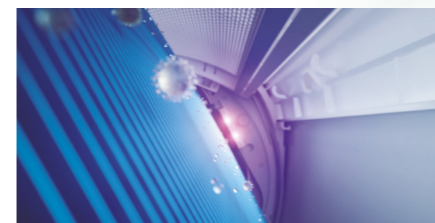
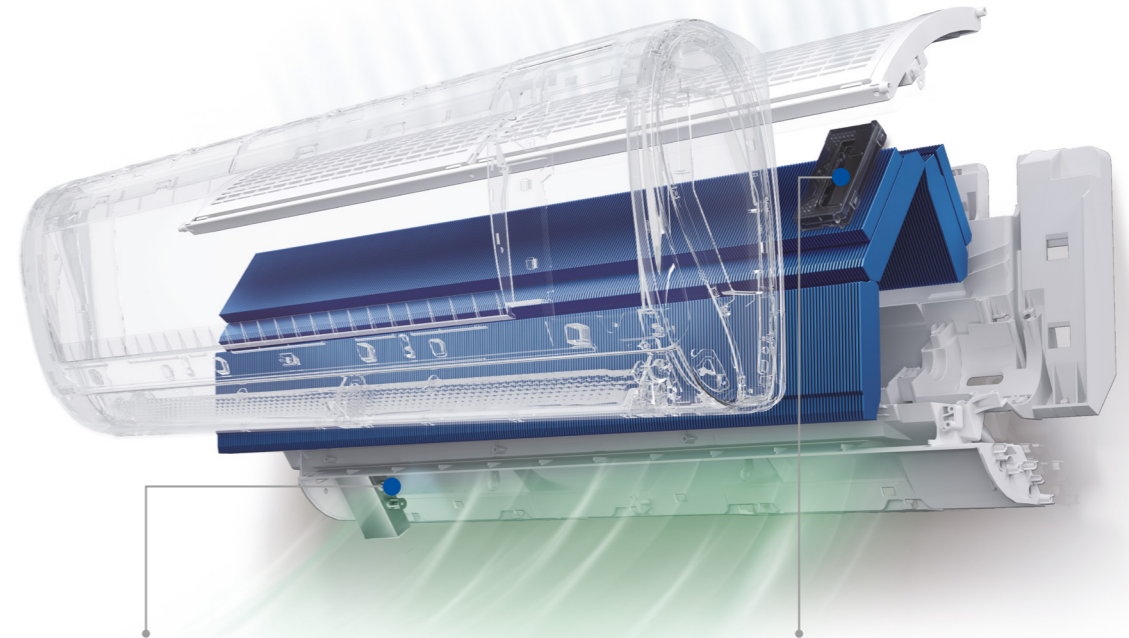

### UVC STERILISATION

Emits UV light to sterilize the air passing through with efficiency up to 99.998%. [Texcell](#)

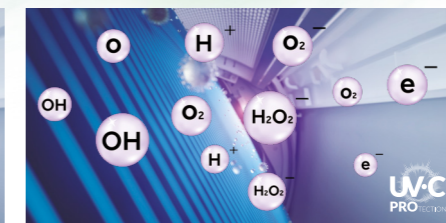

### UVC PRO

Inhibits the reproduction of bacteria, by breaking down hydrogen and oxygen molecule and generates ionic group which inhibits bacteria and sterilises virus after contacting.



### EASY CLEANING

Thanks to the easy disassembly of components it is possible to carry out a more thorough cleaning of the internal surfaces, therefore ensuring the healthiest air comes out of the air conditioner.

# ULTIMATE HEALTH

## UVC PRO STERILISATION

The range includes for the first time the new UVC Pro module which generates plasma to aid sterilisation for a healthier, cleaner, room air environment. The new UVC Pro has been independently tested by Texcell to inhibit SARS-CoV-2 at the unit to 99.991% effectiveness. The UVC Pro is also fast acting and was tested to achieve 85.208% effectiveness in a room space of 6.7m3 in only four hours.

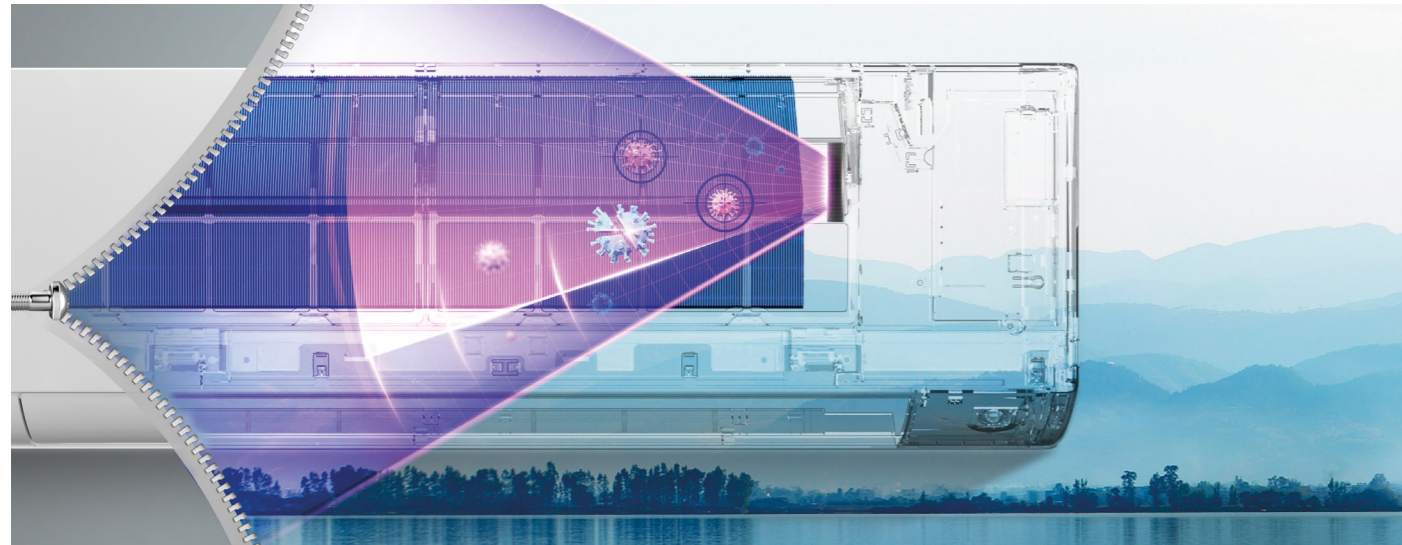

### How it works

UVC Pro is a technology that works in the UV ray spectre and, in particular, in two wavelengths:

- UVC rays that inhibit bacteria and virus present in the airflow that goes through the rays generated by the lamp.
- Vacuum UV rays that generate hydroxyl radicals that release into the environment improving the efficiency of airborne virus and bacteria inhibition.

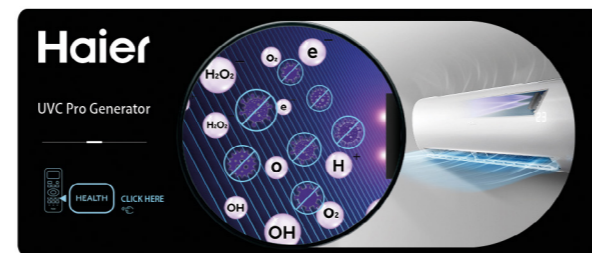

### Powerful air purification

Double efficiency in the air purification with UVC rays and the hydroxyl radicals generated through photolysis. Furthermore, no substance is released into the air, so this technology is environmentally conscious.

### Easy to activate and manage

This function is available through hOn APP and can be activated with a simple touch.

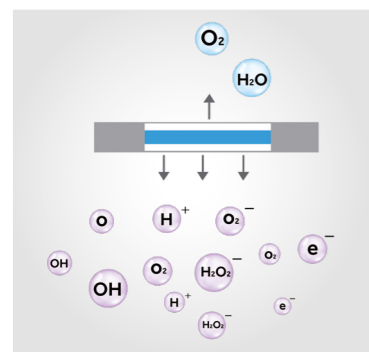

The UV Vacuum ray absorption induces the osmose and the following ionization of the water molecules. Several studies showed that the irradiation of the water molecule with a lamp, with a wavelength of 185nm causes a quick degradation of the microscopic organisms, caused by the decomposition of the organic molecules present in the environment.

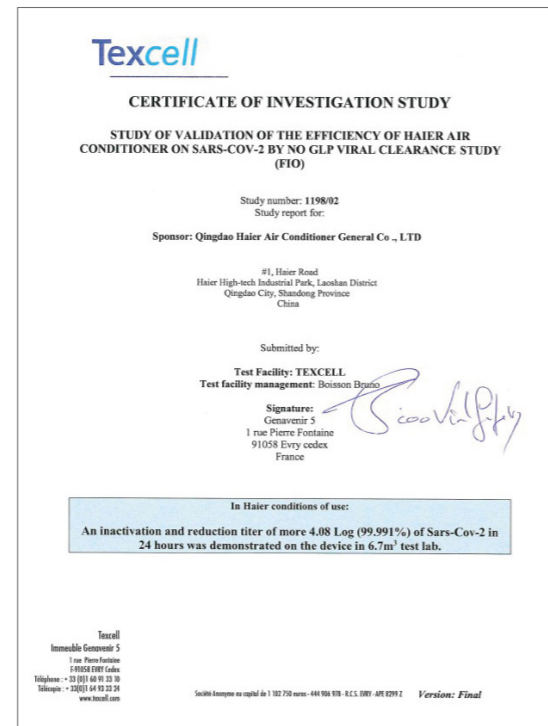

# ULTIMATE HEALTH

## 56°C STERI-CLEAN

Smart frequency control intelligently adjusts the compressor frequency to control the coil temperature and then maintains the evaporator at 56°C high temperature. Based on latest reserach almost no bacteria and virus can survive at 56°C for 30+ minutes. Once the heating process is done, the evaporator is cooled down instantly to achieve better Sterilisation performance.

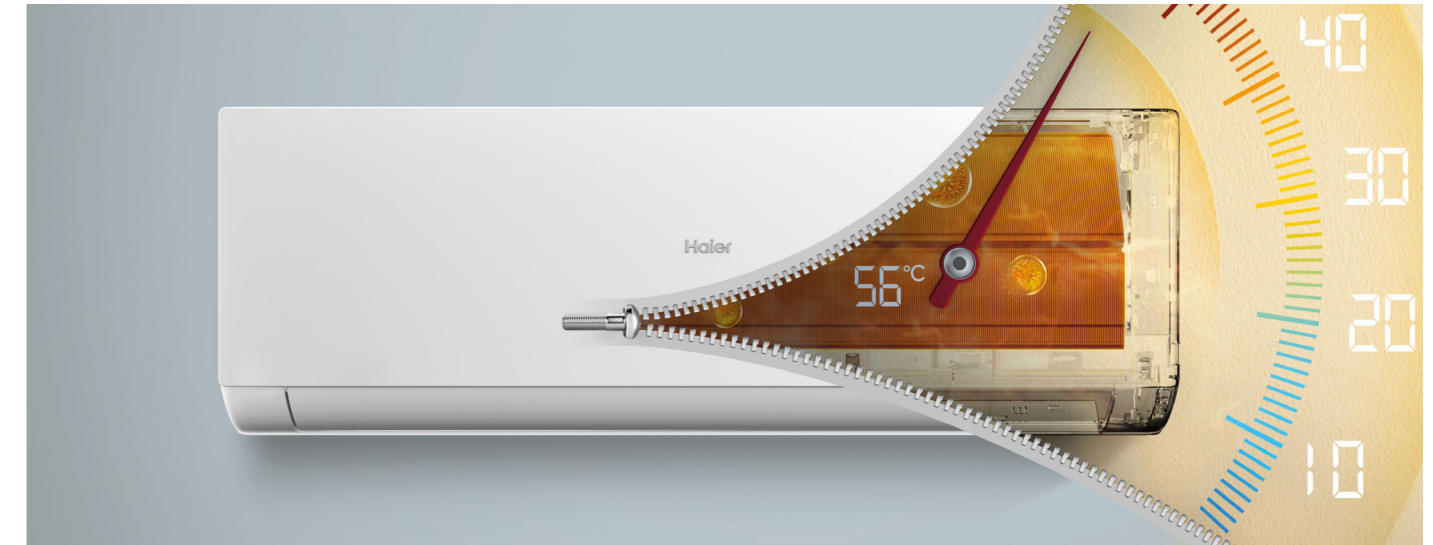

### Delivering Healthier Air

56°C high temperature sterilisation dries the components inside, and kills bacteria and virus, ensuring healthy air coming out of the air conditioner.

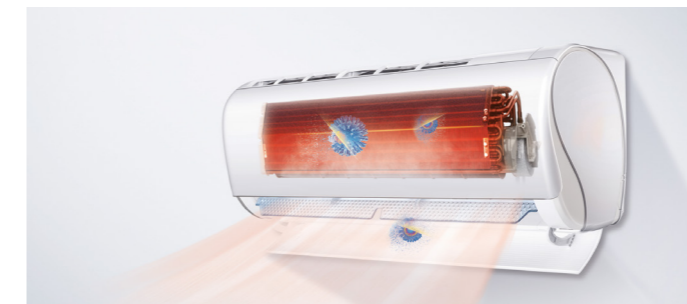

### Easy-to-Operate

The function is available via hOn APP and you can turn it on with just a simple tap.



### Eliminates Bacteria

The viruses and bacteria are eliminated from both the exchanger and other surrounding components of the machine.

The result is also tested by the SGS laboratories which have shown its effectiveness.



# ULTIMATE SMART

## ECO SENSOR



### Technology

The smart sensor detects the condition of air and people's movement in real time, automatically adjusting the operating mode of the air conditioner to improve energy efficiency and optimise the users experience.

With two built-in modules, the Eco sensor uses a double area detection with a maximum angle of 120 degrees and a distance of 8m. The sensor automatically detects the presence of people inside a room and adjusts the air flow by activating the "Follow" or "Avoid" mode according to your specific needs.

### Increased Comfort

If a high body temperature is detected, the fresh air flow is directed towards the person. If a low body temperature is detected, the air flow is diverted.



### Whispering Air







Have you ever been disturbed by the constant hum of an air conditioner during the day or night? On warm summer nights or on a quiet evening? Sometimes a powerful air conditioning system is simply not enough. For your peace of mind, silence also matters. With a noise level of 16 dB (A) (2.5kW) you can have both.

# ULTIMATE SMART

Haier's new Wi-Fi "hOn" app, enables you to take control of all the Haier group appliances in your Smart Home from a single app on your smartphone or tablet. The hOn app allows you to manage all the basic functions and much more. The app can also respond to voice commands because it is compatible with Google Assistant and Alexa.

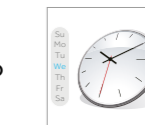
## CUSTOMISED SERVICE

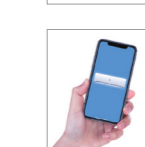
Here are some of the functions you can enjoy with "hOn" app.

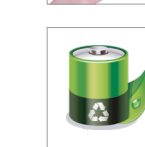
 <p><b>Group Control</b> Control multiple units on one single smart phone device.</p>	 <p><b>Smart Reminder</b> Sends regular notifications to user to clean the filter mesh.</p>	 <p><b>Weekly Timer</b> Sets temperature and fan speed for the week ahead.</p>
 <p><b>Error Alert</b> Error code is shown on the app when it malfunctions.</p>	 <p><b>Convenient Control</b> Controls air conditioner from anywhere and anytime via network.</p>	 <p><b>Custom Program</b> One button for user DIY program.</p>
 <p><b>Voice in APP</b> Built-in voice control for easy for the interaction.</p>	 <p><b>Holiday Mode</b> Set holiday mode with one simple touch.</p>	 <p><b>Energy Consumption</b> Know your electricity consumption in real time.</p>

## INTEGRATED WI-FI MODULE

The Wi-Fi module is already built into the air conditioner. In order to control the units via smartphone or tablet it is necessary to download the hOn app from the App Store, Google Play and Huawei AppGallery. You can also use the QR Code here to locate the app.



## EASY DISASSEMBLY

The indoor unit is designed to allow quick and thorough cleaning of the air conditioner's internal components and simplify disassembly of the main components such as the electronic board, motor and fan. Deep cleaning ensures that bacteria, dust and removal of bacteria, dust and mould that are deposited inside the unit over time and during use.



2,5 kW

3,5 kW

A+++ / A+++

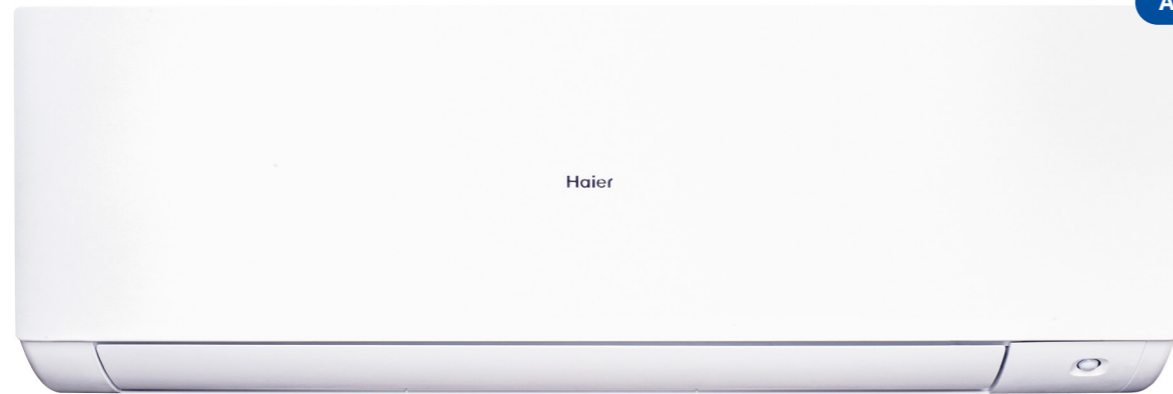

## Outdoor Unit



2,5 kW



3,5 kW

## Controller



Standard YR-HQ

## Technical Illustrations

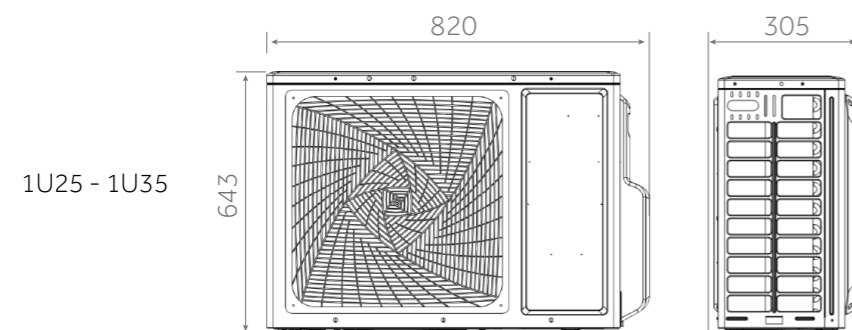
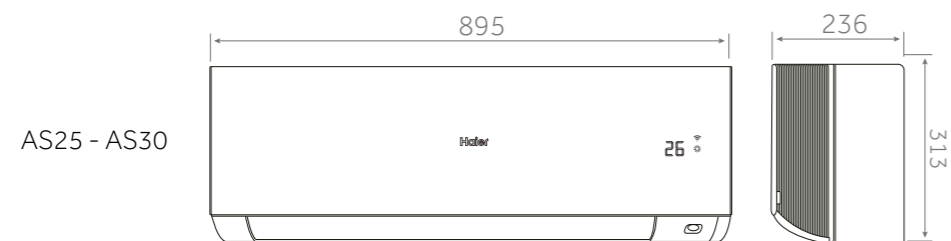

INDOOR UNIT	Model	AS25XCHHRA-NR	AS35XCHHRA-NR	
OUTDOOR UNIT	Model	1U25KEHFRA-NR	1U35KEHFRA-NR	
<b>Performance data</b>				
Output power - COOLING	nom (min-max)	kW	2,6 (1,00-3,50)	3,5 (1,00-4,40)
Output power - HEATING	nom (min-max)	kW	3,20 (1,00-7,40)	4,20 (1,30-7,90)
Absorbed power - COOLING	nom (min-max)	kW	0,577 (0,30-1,14)	0,823 (0,40-1,21)
Absorbed power - HEATING	nom (min-max)	kW	0,761 (0,40-2,40)	1,000 (0,40-2,40)
Energy class	EER	W/W	4,50	4,25
	COP	W/W	4,50	4,25
COOLING Pdesign	35 °C	kW	2,60	3,50
HEATING Pdesign	(-10 °C)	kW	3,00	3,60
Energy class	SEER		8,50 (A+++)	8,50 (A+++)
	SCOP		5,10 (A+++)	5,10 (A+++)
Annual Energy Consumption - COOLING		kWh/a	107	144
Annual Energy Consumption - HEATING		kWh/a	824	988
<b>Indoor Unit</b>				
Power supply		Ph/V/Hz	1/230/50	1/230/50
Treated air volume	H	m3/h	750	810
Dehumidification		L/h	1,2	1,6
High sound power - COOLING		dB	55	56
High sound power - HEATING		dB	55	56
Sound pressure - COOLING		dB(A)	42/32/24/18	43/33/24/18
Sound pressure - HEATING		dB(A)	42/32/24/18	43/33/24/18
Net dimensions	WxDxH	mm	895x236x313	895x236x313
Packaging dimensions	WxDxH	mm	964x386x316	964x386x316
Net/gross weight		kg	12,4/14,8	12,4/14,8
<b>Outdoor Unit</b>				
Power supply		Ph/V/Hz	1/230/50	1/230/50
Power cable		N x mm <sup>2</sup>	3 x 1,5	3 x 1,5
Interconnection cable		N x mm <sup>2</sup>	4 x 1,0	4 x 1,0
Sound power	H	dB	62	63
Sound pressure	H	dB(A)	49	50
Running current cooling/heating	Max	A	10,9/10,9	11,36/11,36
Starting current cooling/heating	Max	A	1,5/1,5	1,5/1,5
Net dimensions	WxDxH	mm	820x305x643	820x305x643
Packaging dimensions	WxDxH	mm	940x390x697	940x390x697
Net/gross weight		kg	35,7/38,5	35,7/38,5
Compressor type			Rotary Inverter	Rotary Inverter
<b>Installation data</b>				
Refrigerant			R32	R32
Liquid pipe	Ø	mm (inch)	6,35 (1/4)	6,35 (1/4)
Gas pipe	Ø	mm (inch)	9,52 (3/8)	9,52 (3/8)
Standard pipe length without refrigerant charge		m	7	7
Maximum pipe length		m	20	20
Maximum IU - OU elevation		m	10	10
Refrigerant charge in the factory		kg	1,1	1,1
Refrigerant charge in the factory		TCO <sub>2</sub> eq	0,743	0,743
Additional ref. charge over std length		g/m	20	20
Operating limits - COOLING (in/out)	min-max	°C	21-35°C/-20-43°C	
Operating limits - HEATING (in/out)	min-max	°C	10-27°C/-30-24°C	

**Haier**  
HVAC Solutions



**EXPERT  
NORDIC** 



**Haier HVAC**  
European HQ

Via Marconi, 96. 31020  
Revine Lago (TV) - Italy  
[haierhvac.eu](http://haierhvac.eu)