

Haier

HVAC Solutions

Professionelle Lösungen
für saubere Luft



WANDGERÄT



TRUHENGERÄT



DECKENKASSETTE



UNTERDECKEN-/
TRUHENGERÄT



KANALEINBAUGERÄT



MULTI

Steuerung von bis zu 5 Innengeräten

Haierhvac.eu

Funktionen

Multisplit-Inverter für den Wohnbereich



Einführung

Haier's Multi-Split-System ermöglicht es Ihnen, Klimakomfort in jedem Zimmer zu genießen.

Ein Multi-Split-System erlaubt es Ihnen, bis zu 5 Innengeräte mittels eines einzigen Außengerätes zu verwalten, und dadurch Installierungsraum und -kosten zu sparen. Alle Innengeräte können unabhängig voneinander verwaltet werden, und müssen nicht zur gleichen Zeit installiert werden, das System kann zukunftsichernd programmiert werden auf bis zu 5 Innengeräte per Außengerät.

Haier's Serie von Innengeräten sind auf eine große Anzahl von Anwendungen ausgerichtet, einschließlich Wandhalterungen, verdeckten Decken, Kassettenbau und auf dem Boden angebrachten Geräten. Diese Geräte sind in einer Reihe von Umfängen erhältlich, welche es Ihnen ermöglichen, die Größe des Systems akkurat anzupassen, um den Gegebenheiten des Zimmers zu entsprechen.

Multi-Split Geräte-Konnektivität

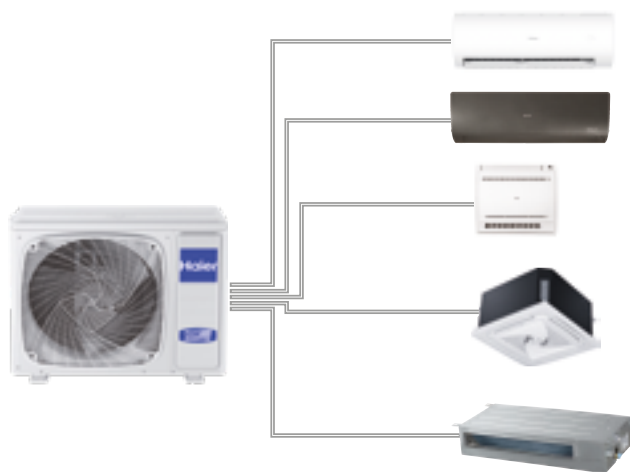

Außengerät



R32 Kältemitte



Hoher Wirkungsgrad



Stille



Einfache Installation

Haier

Funktionen

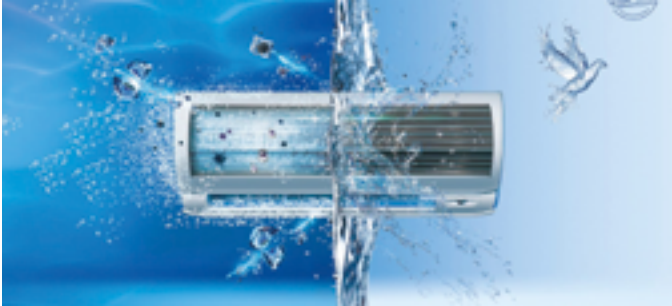

SELBSTREINIGUNG

Friert den Verdampfer mithilfe der Luftfeuchtigkeit ein und entfernt während des Auftauprozesses Schmutz, um eine gesunde Luftleistung zu gewährleisten. Die neue Selbstreinigungstechnologie ist die erste ihrer Art, die die Selbstreinigungsfunktion sowohl des Verdampfers als auch des Kondensators integriert.



HON-WLAN

Dies ermöglicht es Ihnen, alle Geräte der Haier-Gruppe in Ihrem Smart Home über eine einzige App auf Ihrem Smartphone oder Tablet zu steuern. Mit der hOn-App können Sie alle Grundfunktionen und vieles mehr verwalten.

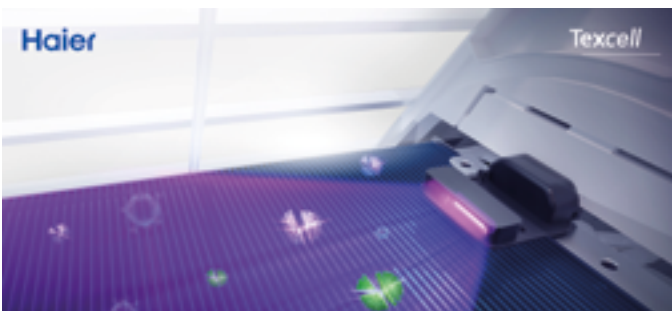

UVC PRO

Hemmt die Vermehrung von Bakterien, indem es Wasserstoff- und Sauerstoffmoleküle aufspaltet und eine ionische Gruppe erzeugt, die Bakterien hemmt und Viren nach dem Kontakt sterilisiert. Das Modul wurde von Texcell unabhängig geprüft und hemmt SARS-CoV-2, mit einer Effizienz von bis zu 99.998% innerhalb einer Stunde (Expert).



EINFACHE MONTAGE

Installation ist vereinfacht, mit größeren Arbeitsräumen und leichter Demontage und Wartung. Rohre und Kabel können einfach miteinander verbunden werden aufgrund einer entfernbaren Unterplatte.



GERÄUSCHLOS

Optimiertes Design der Belüftungsschächte und Motoren, um kühlere, komfortablere Luft zu liefern, mit einem niedrigen Geräuschpegel, so dass Sie Ihren Innenraum genießen können.























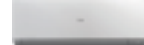
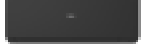
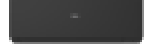
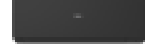
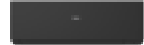





















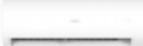

ECO-SENSOR

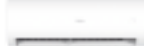
Der intelligente Sensor erkennt den Zustand der Luft und die Bewegung der Menschen in Echtzeit und passt automatisch den Betriebsmodus der Klimaanlage an, um die Energieeffizienz zu verbessern und die Benutzererfahrung zu optimieren. Er nutzt Doppelflächenerkennung mit einem maximalen Winkel von 120 Grad und einem Abstand bis zu 8m.

Kompatibilität

Multi-Split-Inverter für den Wohnbereich

INNENGERÄTE MULTI-SPLIT R32					
SERIE	2,0 kW	2,5 kW	3,5 kW	5,0 kW	6,8 / 7,1 kW
JADE		 AS25S2SJ1FA-3	 AS35S2SJ1FA-3	 AS50S2SD1FA-3	
	 I Feel	 Puri Clean	 Selbst-Hygiene	 Stille	 Wi-Fi Steuerung
				 3D	 2-Wege Rohrleitung-skizzenkonzept
NEU EXPERT Schwarz & Weiß	 AS20XCAHRA	 AS25XCAHRA	 AS35XCAHRA	 AS50XCAHRA	
	 AS20XCAHRA-MB	 AS25XCAHRA-MB	 AS35XCAHRA-MB	 AS50XCAHRA-MB	
	 Einfache Installation	 I Feel	 Selbstreinigung	 Coanda Plus	 Oko-Sensor
				 Einfache Demontage	 UVC Pro
					 2-Wege Rohrleitung-skizzenkonzept
FLEXIS PLUS Schwarz & Weiß	 AS20S2SF1FA-MB3	 AS25S2SF1FA-MB3	 AS35S2SF1FA-MB3	 AS50S2SF1FA-MB3	 AS71S2SF1FA-MB3
	 AS20S2SF1FA-MW3	 AS25S2SF1FA-MW3	 AS35S2SF1FA-MW3	 AS50S2SF1FA-MW3	 AS71S2SF1FA-MW3
	 I Feel	 Oko-Sensor	 Einfache Installation	 Stille	 Wi-Fi Steuerung
				 UVC Sterilisation	
PEARL	 AS20PBAHRA	 AS25PBAHRA	 AS35PBAHRA	 AS50PDAHRA	 AS68PDHARA
	 Coanda Plus	 Selbstreinigung	 Stille	 UVC Sterilisation	 Wi-Fi Steuerung

INNENGERÄTE MULTI-SPLIT R32					
SERIE	2,5 kW	3,5 kW	4,2 kW	5,0 kW	7,1 kW
TRUHENGERÄT	 AD25S2SD1FA(D)	 AD71S2SD1FA(D)	 AF42S2SD1FA(D)		
	 Stille  Doppelter Durchfluss  Schlaf  hOn Wi-Fi-Steuerung  R32 Detektor				
DECKENKASSETTE 620	 AB25S2SC2FA(H)	 AB35S2SC2FA(H)		 AB50S2SC2FA(H)	
	 Stille  4-Wege unabhängig  hOn Wi-Fi-Steuerung  Frischluft  Ein/Aus-Karte  UVC Sterilisation				
DECKENKASSETTE ROUND FLOW					 AB71S2SG1FA(H)
	 Stille  8-wegig unabhängig  hOn Wi-Fi-Steuerung  Frische Luft  UVC Sterilisation				
UNTERDECKEN-/TRUHENGERÄT		 AC35S2SG1FA(H)		 AC50S2SG1FA(H)	 AC71S2SG1FA(H)
	 Stille  Durchfluss +  Funftufiger Lüfter  Frischluft  Ein/Aus-Karte  hOn Wi-Fi-Steuerung  UVC Sterilisation				
KANALEIN-BAUGERÄT FLACHES DESIGN	 AD25S2SS1FA(H)	 AD35S2SS1FA(H)		 AD50S2SS1FA(H)	 AD71S2SS1FA(H)
	 Stille  Kompaktes Design  3D  Kondensat Abflusspumpe  Flexible Installation  UVC Sterilisation  hOn Wi-Fi-Steuerung				
KANALEIN-BAUGERÄT MITTLERER DRUCK		 AD35S2SM3FA(H)		 AD50S2SM3FA(H)	 AD71S2SM3FA(H)
	 Stille  Kompaktes Design  3D  Kondensat Kondensat-Pumpe  Flexibel Installation  UVC Sterilisation  hOn Wi-Fi-Steuerung integrierte				

Kompatibilität

Multi-Split-Inverter für den Wohnbereich

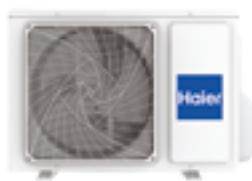

SELBSTREINIGUNG

1:2 2U40S2SM1FA
2U50S2SM1FA-3



1:3 3U55S2SR5FA
3U70S2SR5FA



1:4 4U75S2SR5FA
4U85S2SR5FA

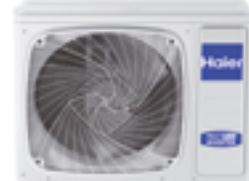

1:5 5U90S2SS5FA
5U105S2SS5FA
5U125S2SN1FA

Außengerät	Modell		2U40S2SM1FA	2U50S2SM1FA-3	3U55S2SR5FA	3U70S2SR5FA	4U75S2SR5FA	4U85S2SR5FA	5U90S2SS5FA	5U105S2SS5FA	5U125S2SN1FA
Leistungsdaten											
Ausgangsleistung - Kühlen	Nennwert (Min-Max)	KW	4,00 (1,00-4,50)	5,00 (1,10-5,60)	5,50 (2,10-7,00)	7,00 (2,40-7,60)	7,50 (2,40-8,70)	8,50 (3,20-9,50)	9,00 (3,20-11,00)	10,00 (3,20-11,00)	12,50 (3,20-13,80)
Ausgangsleistung - Heizen	Nennwert (Min-Max)	KW	4,00 (1,50-4,80)	5,20 (1,40-6,00)	6,80 (1,70-7,60)	7,60 (2,90-8,50)	8,60 (3,10-10,00)	9,60 (4,40-10,50)	10,40 (4,40-11,50)	10,50 (4,40-11,50)	12,70 (4,40-14,50)
Leistungsaufnahme - Kühlen	Nennwert (Min-Max)	KW	1,00	1,43	1,35	1,84	1,97	2,50	2,79	3,47	3,87
Leistungsaufnahme - Heizen	Nennwert (Min-Max)	KW	1,07	1,40	1,66	1,85	2,15	2,40	2,79	2,82	3,40
Energieklasse	EER	W/W	4,00	3,45	4,00	3,81	3,80	3,40	3,23	2,88	3,23
	COP	W/W	4,10	3,71	4,10	4,10	4,00	4,00	3,73	3,73	3,73
Kühlen Pdesign	35 °C	KW	4,00	5,00	5,50	7,00	7,50	8,00	9,00	10,00	12,50
Heizen Pdesign	(-10 °C)	KW	3,30	4,70	4,70	6,00	6,30	7,00	7,20	8,00	9,50
Energieklasse	SEER		6,50 (A++)	6,50 (A++)	8,50 (A+++)	7,50 (A++)	7,00 (A++)	7,00 (A++)	7,00 (A++)	7,00 (A++)	7,10 (A++)
	SCOP		4,00 (A+)	4,00 (A+)	4,00 (A+)	4,20 (A+)	4,00 (A+)	4,00 (A+)	4,00 (A+)	4,00 (A+)	4,05 (A+)
Jährlicher Energieverbrauch - Kühlen		kWh/a	269	269	227	332	379	456	457	537	622
Jährlicher Energieverbrauch - Heizen		kWh/a	1645	1645	1678	2012	2179	2503	2441	2889	3346
Außengerät											
Stromversorgung		Ph/V/Hz	1/220 (240/50/60)								
Netzkabel		N x mm ²	3 x 2,5	3 x 2,5	3 x 4,0	3 x 4,0	3 x 4,0	3 x 4,0	3 x 4,0	3 x 4,0	3 x 4,0
Verbindungskabel		N x mm ²	4 x 1,0	4 x 1,0	4 x 2,5	4 x 2,5	4 x 2,5	4 x 2,5	4 x 2,5	4 x 2,5	4 x 2,5
Luftmenge	Max	m ³ /h	2200	2400	3000	3000	4000	4000	4 200	4 200	4 200
Schalleistung	Max	dB	62	63	64	66	68	68	70	70	73
Schalldruck	Max	dB(A)	52	53	51	53	55	55	55	55	58
Betriebsstrom Kühlen/Heizen	Max	A	7,3/8,2	9,1/9,1	10,8/9,5	11,9/9,7	14,7/13,5	15,5/14,6	18,2/14,6	18,2/14,6	23,0/18,7
Anlaufstrom Kühlen/Heizen	Max	A	3,0/3,0	3,0/3,0	4,0/4,0	4,0/4,0	5,0/5,0	5,0/5,0	5,0/5,0	5,0/5,0	5,0/5,0
Nettoabmessungen	BxTxH	mm	800 x 275 x 553	800 x 275 x 553	890 x 340 x 700	890 x 340 x 700	890 x 340 x 700	890 x 340 x 700	920x372x765	920x372x765	950x370x965
Verpackungsabmessungen	BxTxH	mm	954x409x625	954x409x625	1010x455x835	1010x455x835	1010x455x835	1010x455x835	1045x488x890	1045x488x890	1050x485x1170
Netto-/Bruttogewicht		kg	34,0/37,0	36,0/39,0	50,0/59,0	54,0/63,0	61,0/70,0	61,0/70,0	66,0/77,0	66,0/77,0	79,0/91,0
Kompressortyp			Doppel-Drehwechselrichter								
Installationsdaten											
Kältemittel			R32	R32	R32	R32	R32	R32	R32	R32	R32
Flüssigkeitsleitung	Ø	mm (Zoll)	2x6,35 (3x1/4)	2x6,35 (3x1/4)	3x6,35 (3x1/4)	3x6,35 (3x1/4)	4x6,35 (4x1/4)	4x6,35 (4x1/4)	5x6,35 (5x1/4)	5x6,35 (5x1/4)	5x6,35 (5x1/4)
Sauggasleitung	Ø	mm (Zoll)	2x9,52 (3x3/8)	2x9,52 (3x3/8)	3x9,52 (3x3/8)	3x9,52 (3x3/8)	3x9,52+1x12,70 (3x3/8+1x1/2)	3x9,52+2x12,70 (3x3/8+2x1/2)			
Standardrohrlänge ohne zus. Kältemittelfüllung	m		20	20	30	30	40	40	40	40	50
Maximale Rohrlänge	m		30	30	50	60	70	70	80	80	100
Max. Höhendifferenz IG/AG	m		15	15	15	15	15	15	15	15	15
Max. Höhendifferenz IG/AG	m		7,5	7,5	7,5	7,5	7,5	7,5	7,5	7,5	7,5
Kältemittelmenge vorgefüllt	kg		1,00	1,40	1,40	1,60	1,60	2,20	2,40	2,40	2,50
CO ₂ -Äquivalent	TCO ₂ eq		0,68	0,95	0,95	1,08	1,08	1,49	1,62	1,62	1,69
Kältemittelnachfüllmenge	g/m		20	20	20	20	20	20	20	20	20
Außentemperaturbereiche - KÜHLEN	Min-Max	°C	-10° - 43°C				-10° - 46°C				
Außentemperaturbereiche - HEIZEN	Min-Max	°C	-15° - 24°C								

- 4,0 kW
- 5,0 kW
- 5,5 kW
- 7,0 kW
- 8,5 kW
- 9,0 kW
- 10,5 kW
- 12,5 kW

Haier

2U40S2SM1FA (2 Anschlüsse)

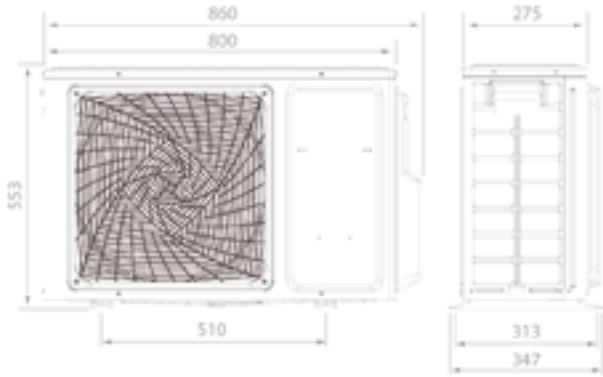

2U50S2SM1FA-3 (2 Anschlüsse)

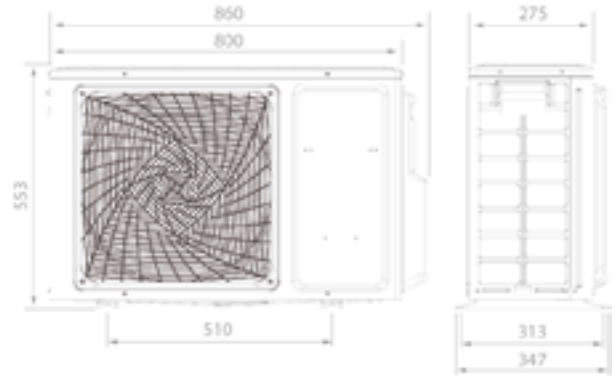

3U55S2SR5FA - 3U70S2SR5FA (3 Anschlüsse)

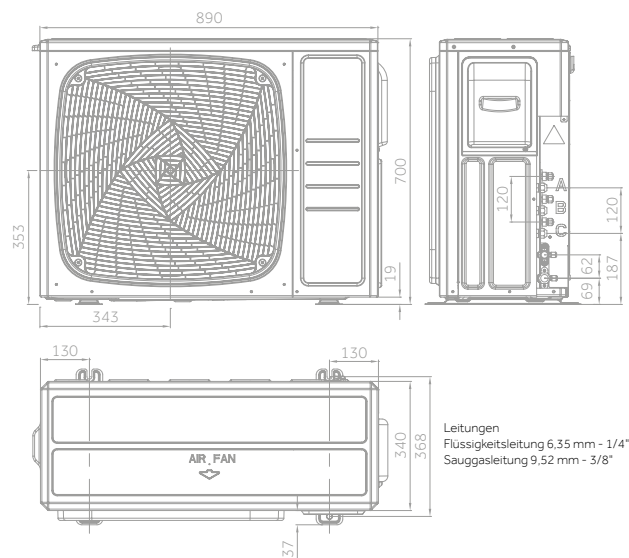

4U75S2SR5FA - 4U85S2SR5FA (4 Anschlüsse)

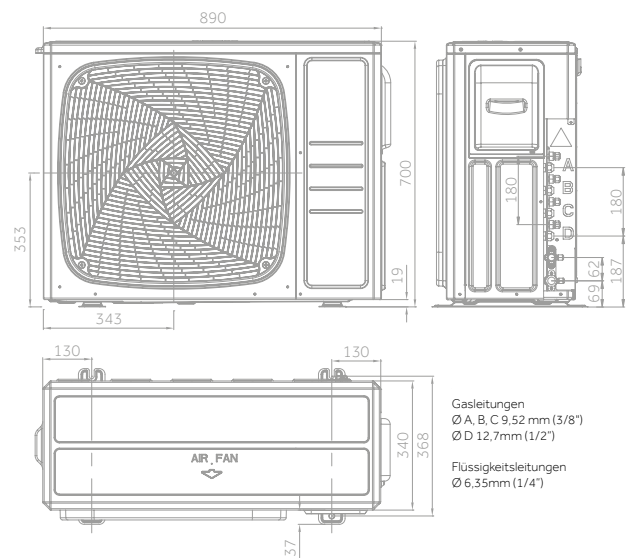

5U90S2SS5FA - 5U105S2SS5FA (5 Anschlüsse)

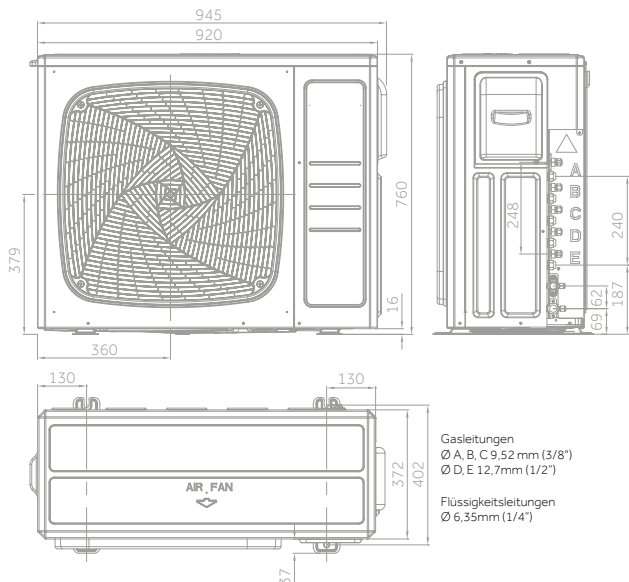

5U125S2SN1FA (5 Anschlüsse)

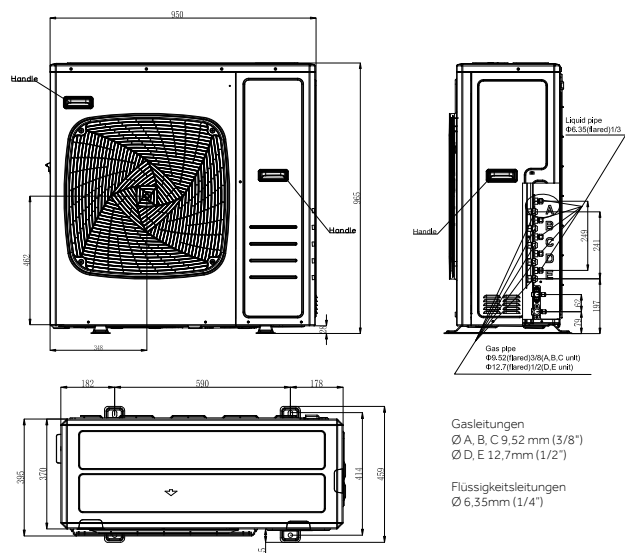

Haier
HVAC Solutions



MULTI

Multi-Split-Inverter
für den Wohnbereich



Haier HVAC
Europäische Zentrale
Via Marconi, 96. 31020
Revine Lago (TV) - Italia
haierhvac.eu